

Digital Telecom Analyzer
Operating and Calibration Manual

SERIAL NUMBERS

This manual applies directly to instruments with firmware revision (MAIN) number 3505. To check the firmware revision number of your instrument, press **OTHER** and select **OPTIONS**.



HP Part No. 37722-90024
Printed in U.K. October 1995

Copyright © Hewlett-Packard Ltd. 1995

WARNING

READ THE FOLLOWING NOTES BEFORE INSTALLING OR SERVICING ANY INSTRUMENT.

1. IF THIS INSTRUMENT IS TO BE ENERGISED VIA AN AUTO-TRANSFORMER MAKE SURE THAT THE COMMON TERMINAL OF THE AUTO-TRANSFORMER IS CONNECTED TO THE NEUTRAL POLE OF THE POWER SOURCE.
2. THE INSTRUMENT MUST ONLY BE USED WITH THE MAINS CABLE PROVIDED. IF THIS IS NOT SUITABLE, CONTACT YOUR NEAREST HP SERVICE OFFICE. THE MAINS PLUG SHALL ONLY BE INSERTED IN A SOCKET OUTLET PROVIDED WITH A PROTECTIVE EARTH CONTACT. THE PROTECTIVE ACTION MUST NOT BE NEGATED BY THE USE OF AN EXTENSION CORD (POWER CABLE) WITHOUT A PROTECTIVE CONDUCTOR (GROUNDING).
3. BEFORE SWITCHING ON THIS INSTRUMENT:
 - a. Make sure the instrument input voltage selector is set to the voltage of the power source.
 - b. Ensure that all devices connected to this instrument are connected to the protective (earth) ground.
 - c. Ensure that the line power (mains) plug is connected to a three-conductor line power outlet that has a protective (earth) ground. (Grounding one conductor of a two-conductor outlet is not sufficient).
 - d. Check correct type and rating of the instrument fuse(s).

WARRANTY

This Hewlett-Packard product is warranted against defects in materials and workmanship for a period of one year from date of shipment. During the warranty period, Hewlett-Packard Company will, at its option, either repair or replace products which prove to be defective.

For warranty service or repair, this product must be returned to a service facility designated by HP. Buyer shall prepay shipping charges to HP and HP shall pay shipping charges to return the product to Buyer. However, Buyer shall pay all shipping charges, duties, and taxes for products returned to HP from another country.

HP warrants that its software and firmware designated by HP for use with an instrument will execute its programming instructions when properly installed on that instrument. HP does not warrant that the operation of the instrument, or software, or firmware will be uninterrupted or error free.

LIMITATION OF WARRANTY

The foregoing warranty shall not apply to defects resulting from improper or inadequate maintenance by Buyer, Buyer-supplied software or interfacing, unauthorized modification or misuse, operation outside of the environment specifications for the products, or improper site preparation or maintenance.

NO OTHER WARRANTY IS EXPRESSED OR IMPLIED. HP SPECIFICALLY DISCLAIMS THE IMPLIED WARRANTIES OF MERCHANTABILITY AND FITNESS FOR A PARTICULAR PURPOSE.

EXCLUSIVE REMEDIES

THE REMEDIES PROVIDED HEREIN ARE BUYER'S SOLE AND EXCLUSIVE REMEDIES. HP SHALL NOT BE LIABLE FOR ANY DIRECT, INDIRECT, SPECIAL INCIDENTAL, OR CONSEQUENTIAL DAMAGES, WHETHER BASED ON CONTRACT, TORT, OR ANY OTHER LEGAL THEORY.

CERTIFICATION

Hewlett-Packard Company certifies that this product met its published specifications at the time of shipment from the factory. Hewlett-Packard further certifies that its calibration measurements are traceable to the United States National Bureau of Standards, to the extent allowed by the Bureau's calibration facility and to the calibration facilities of other International Standards Organization members.

ASSISTANCE

Product maintenance agreements and other customer assistance agreements are available for Hewlett-Packard products.

For any assistance, contact your Hewlett-Packard Sales and Service Office. Addresses are provided at the back of this manual.

Notice

The information contained in this document is subject to change without notice.

Hewlett-Packard shall not be liable for errors contained herein or for incidental or consequential damages in connection with the furnishing, performance or use of this material.

This document contains proprietary information which is protected by copyright. All rights are reserved. No part of this document may be photocopied or reproduced without the prior written consent of the manufacture, Hewlett-Packard Ltd.

EMC COMPLIANCE

This product has been tested and complies with FTZ 1046 when used with the following cables:

Cable	HP Part Number
3-pin Siemens	15512A E01
RS-232/V.24	15714A E01
V.35	15708A E01
RS-449/V.11	15692A E01

PRINTING HISTORY

Edition 1 (37722-90000)	April 1991
Edition X.58-NL-PTT (37722-90002)	August 1991
Edition 1 (37722-90005)	January 1992
Edition 2 (37722-90005)	June 1992
Edition 1 (37722-90010)	February 1993
Edition 1 (37722-90014)	March 1993
Edition 1 (37722-90016)	July 1993
Edition 1 (37722-90020)	August 1994
Edition 1 (37722-90024)	October 1995

Contents

1. Getting Started	
Before Getting Started	1-1
Getting Started	1-2
Switch On	1-2
To Set the Analyzer to a Known State	1-3
To Choose EFS or %EFS as the Current Results Display	1-5
To Loop Transmit/Receive and Make a Measurement	1-6
To Add Errors at a Fixed Rate	1-8
To See Alarm Indicator Operation	1-9
To See an Alarm Record	1-9
To See Results	1-10
To See Results as Graphs	1-12
After Getting Started	1-15
2. Getting Ready for Telecom Testing	
To Select Telecom on Combined Telecom/Datacom Test Sets	2-2
To Release Keyboard Lock	2-2
Fast Set Up	2-3
To Automatically Set Frame, Code and Pattern To The Incoming Signal	2-3
To Recall A Stored Set-Up	2-4
To Set Up For Storage of Results	2-5
To Set Up Long User Words	2-6
To Set a Test Period	2-7
To Set Framing and Signaling Bits	2-8
For 2Mbit/s Operation	2-8
For 704kbit/s Operation	2-9
To Set Analysis Thresholds	2-10
To Select Standard Annex D Thresholds	2-10
To Select Your Own Thresholds.	2-11

To Set the Content of Background Timeslots	2-12
To Choose EFS or %EFS as the Current Results Display	2-13
To Select Sub rate Bits and Mapping	2-14
To Set the Binary Clock/Date Phase	2-16
To Store Test Set-Ups	2-17
To Indicate Stored Set-Up Content	2-19
To Set the Date and Time	2-20
To Start the Clock at the Selected Time	2-21
To Set BEEP on Errors	2-22
To Communicate Over the Line Under Test	2-23
Setting the start time for a timed start measurement	2-25
Setting for result printing at timed intervals	2-25
Setting the Pattern Loss Threshold	2-26
Setting BIS M.2100 Thresholds	2-26
M.2120 TR2 Factor selection	2-26

3. Telecom Testing

Out Of Service Testing	3-4
Network Performance Evaluation	3-4
To make a Typical Commissioning Test	3-4
To Check Timeslot Integrity (including $n \times 64$) End/End	3-7
To Trace an Individual Timeslot	3-9
To Investigate Pattern Dependent Errors	3-10
To Test Individual Channel Error Performance.	3-11
Mux Performance evaluation	3-13
To Test the Mux / Demux Function	3-13
To Check Sync Loss and Regain Thresholds.	3-15
To Test Multiplexer Response to Incoming Alarms and Alarm Conditions	3-17
To Test Network Equipment Synchronization Criteria	3-22
To Check an X.50/X.58 Channel on Both Sides of a Multiplexer	3-25
To Generate the Test Pattern	3-25
To Measure Errors at 64kbit/s or 2Mbit/s Monitor Points	3-28
To Test Speech Quality (A/D, D/A Performance)	3-30
To Test Timeslot Switching Capability with Input Level Variation	3-32
To Make Analog Measurements on Digital Channels.	3-34

Real time data service Installation	3-35
To Measure Round trip Delay.	3-36
To Loopback Using NFAS Codes	3-38
Bringing Into Service (BIS) M.2100 Testing	3-41
M.2100 Testing	3-41
M.2110 and M.2120 Testing	3-41
In Service Testing and Troubleshooting	3-43
To Monitor error performance.	3-43
To Investigate infrequent alarm and error bursts	3-43
To Isolate the source of errors :	3-46
To Find an Idle Timeslot or to look for Stuck Bits (CAS)	3-46
To Isolate a Wideband, or Single Timeslot, Error Source	3-48
Troubleshooting data from packet-type signaling protocols.	3-51
CRC4 Network Performance Evaluation From One Location.	3-53
To Monitor ISDN Error Performance Data in the CRC4 NFAS Word.	3-57
To Monitor VF Traffic in Channels	3-59
To Monitor Sub-rate Frame and Data Bits	3-61
To Run a User Protocol in a Circuit	3-66
Full Measurement List	3-69
Tx/Rx rates	3-70
Investigating the Source of Slips	3-71

4. Displaying Error and Alarm Test Results

To Display Alarms	4-2
To See the Current Alarm Conditions.	4-2
To See the Alarm History	4-3
To See the Record of Total Alarm Durations.	4-4
To Display Errors	4-5
To Select One of the Error Displays	4-6
To Display the Error Count of Each Error Type	4-6
To Display Details of One Error Type	4-7
For a G.821 Analysis Display of One Type Of Error	4-8
For an M21XX Analysis (Bringing into Service)	4-9
For an M21XX Analysis (In Service)	4-10
To Display Signal Results	4-11
To Display Alarm and Error Graphs	4-12
To Select One of the Graphic Displays	4-13

To Select the Time "Window" and Resolution of the Graphic Display	4-13
To Return to the Normal Measurement Display	4-14
To Display Stored Results	4-15
To Display One of the Stored Results.	4-15
Graphic Display - to Select Error Type or Alarms	4-17
Numeric Display - to Select Error Type or Alarms	4-17
To Return to the Normal Measurement Display	4-17
5. Printing Results	
To Select the Printer Output.	5-2
To Select an Output Suitable for a Hewlett-Packard 80 Column Printer.	5-2
Example Set-Up Using a Hewlett-Packard Thinkjet Printer, Model 2225D.	5-3
To Select an Output Suitable for an Alternative Printer.	5-4
To Print	5-5
To Print The Results of the Current / Last Test	5-5
To Print the Results of the Current / Last Test as a Numeric List	5-5
To Print The Results of the Current Test at Timed Intervals	5-5
To Print the Results of the Last Test as Graphs of Alarms and Error Count	5-5
To Print Stored Results	5-9
To Print Stored Results as a Numeric List	5-10
To Print Stored Results as Graphs of Alarms and Error Counts	5-11
6. General Information	
Introduction	6-1
Specification	6-1
Safety Considerations	6-2
Options Available	6-2
Accessories Supplied	6-3
Accessories Available	6-3
Specification	6-4
Specification	6-5
Facilities	6-5

TRANSMITTER	6-7
2 Mbit/s Transmitter	6-7
64 kbit/s Transmitter	6-10
RECEIVERS	6-11
2 Mbit/s Receiver	6-11
64 kbit/s Receiver	6-14
Telecom Measurements	6-15
M.2100	6-21
General Specifications	6-24
Graphics	6-24
Storage	6-24
Printer Output	6-25
Remote Control	6-26
Environmental	6-28
Options	6-28
Option 002 - 8 Mbit/s Transmit/Receive	6-28
Option 003 - 704kbit/s Transmit/Receive	6-32
Option 004 - Small Siemens Connectors	6-36
Option 005 - Sub rate testing, timeslot access, tone generation and measurement.	6-36
Circuit numbering	6-40
X58 - ETSI	6-41
Option 006 Timeslot Access, Tone Generation and Measurement.	6-43
Option 210	6-45
Option B12	6-46
Option B48	6-47
Option H02	6-47
Option H08	6-47
Option V01	6-47
Option 010 - Relative Frequency	6-47

7. Installation	
Introduction	7-1
Initial Inspection	7-1
Preparation for Use	7-2
Power Requirements	7-2
Line Fuses	7-2
Power Cable	7-3
Battery (Option B12)	7-3
To Charge the Batteries (Option B12)	7-4
To Change the Batteries	7-4
Battery Fuses	7-5
To Change a Blown Fuse	7-5
Mating Connectors (Front and Side Panels)	7-6
T1 Tester Selection When Using a T1/DATACOM TEST SET	7-6
External Clock Input	7-7
ACCESSORY Port - for Datacom Module Connection	7-7
RS-232 Port - for Printer or Remote Control Connection	7-7
Modem Connection	7-9
Rack Mounting	7-10
DATACOM Port - for Drop and Insert Interface	7-12
Operating Environment	7-13
Storage and Shipment	7-13
Environment	7-13
Packaging	7-14
8. Performance Tests	
Introduction	8-1
Calibration Cycle	8-2
Recommended Test Equipment	8-2
Operational Verification, Telecom	8-4
Default Settings	8-5
Operational Verification, Telecom	8-6
Self Test, Telecom	8-7
Telecom Self Tests, Order and Fail Codes	8-9
Internal Transmitter Clocks	8-10
Mux & Demux Tests	8-13
Mux & Demux Tests (Options 005/006 only)	8-21
External Drop and Insert (Options 005/006 only)	8-27

Performance Tests, Telecom	8-30
Self Test	8-31
Telecom Self Tests, Order and Fail Codes	8-33
Internal Transmitter Clocks	8-34
External Transmitter Clock	8-37
Transmitter Output	8-40
Binary Data and Clock Outputs	8-51
Receiver Equalization, Additional Gain and Looped Timing	8-56
Receiver Frequency Measurement	8-62
Alarms Tests	8-64
Mux & Demux Tests	8-65
Mux & Demux Tests (Options 005/006 only)	8-73
External Drop and Insert (Options 005/006 only)	8-79
Auto Configure	8-81
Wander and Bit Slips (Option 010 instruments only)	8-83

9. Remote Control

Preparation for Remote Control	9-1
To Connect to Telephone Lines via Modems	9-2
To Connect for Direct Operation	9-3
To Set the Analyzer for Operation from a Terminal	9-4
To Set the Analyzer for Operation from a Computer	9-5
Remote Operation	9-6
Terminal Control	9-7
Prompting and Input Editing	9-8
The Prompt	9-8
Input Editing	9-8
Error Reporting	9-8
Mnemonic Responses	9-9
HP-IB Operation (option H02)	9-11
Connecting to the HP-IB	9-12
Operating Distances	9-12
Hewlett-Packard Interface Bus Connector	9-12
Suitable Cables	9-13
Connection Over Greater Distances	9-14
Setting Up for Printing or Controlling	9-14
To Print using Talk Only	9-14
To Control the Instrument Remotely	9-14

Communication with the System Controller	9-14
HP-IB Address Selection	9-15
To Return to Local Operation	9-15
Status Reporting	9-15
Service Request Interrupt Routine	9-16
Poll Using STB?	9-16
HP-IB Capability	9-16
HP-IB Universal Commands	9-17
Programming Tips	9-19
THE COMMANDS	9-21
COMMON CAPABILITY COMMANDS	9-21
Reset	9-21
Self-test	9-21
Remote	9-22
Local	9-22
Clear	9-22
Configuration	9-23
Key Query	9-23
Request Service Mask	9-24
Instrument Identification	9-25
Revision Date Query	9-26
Serial Number Query	9-26
Error Code Query	9-27
Ready Code Query	9-27
Status/Events Query	9-27
Status Query	9-27
Options Query	9-28
INSTRUMENT SETTINGS COMMANDS	9-29
Application Mode	9-29
Interface Type	9-29
Binary Interface Transmit Clock Phase	9-30
Binary Interface Receive Clock Phase	9-30
Ternary Linecode	9-30
Sub Rate Structure	9-30
Sub Rate Bearer Rate	9-31
Framing Type	9-31
Through Mode	9-32
Transmitter Clock Source	9-32

Transmitter Octet Timing	9-32
Pattern Type	9-33
PRBS Polarity	9-33
User Defined Word Pattern	9-34
Sub Rate X.50 Status Bit	9-34
Tone Frequency	9-34
User Defined Tone Frequency	9-35
Tone Level	9-35
Transmitter Multiple Timeslot Selection	9-35
Transmit Single Timeslot	9-36
Receive Timeslot	9-36
Receiver Single Timeslot	9-36
Receiver Multiple Timeslot Selection	9-37
Sub Rate Bearer Timeslot	9-37
Sub Rate Channel Number	9-37
External Drop + Insert Data Source	9-38
Data Insert To Timeslot	9-38
Data Insert Timeslot Enable	9-39
Data Drop From Timeslot	9-39
Sub Rate Deselected Octets Pattern	9-40
M.2100 limits command	9-40
Speaker Enable	9-41
M.2110 limits	9-41
M.2120 limits	9-42
Set M.21XX Path Allocation	9-42
Set pattern loss threshold	9-42
Stored Path Allocation	9-43
Stored M.2100 Limits Query	9-43
OTHER-PAGE FUNCTIONS	9-44
Save Settings	9-44
Recall Settings	9-44
Settings Lock	9-44
Name Stored Setting	9-44
Date Set-Up	9-45
Time Set-Up	9-46
Keyboard Lock	9-46
External RS-232 Printer Set-Up	9-46
Audio Source (Beep On Error)	9-47

Long User Word Selection Number	9-48
Long User Word Byte Length	9-48
Long User Word Pattern Synchronisation Length	9-49
Long User Word User Program Synchronisation Length	9-49
Long User Word Send Left Hand Bit	9-50
Long User Word Pattern	9-50
Printer auto trigger	9-51
KEYBOARD FUNCTION SETTINGS COMMANDS	9-52
Receiver Auto-Setup	9-52
Start Testing	9-52
Stop Testing	9-52
Timed start, date and time	9-53
Volume Control	9-54
Show History Status Query	9-54
History Reset	9-54
Single Error Add	9-54
Print Now	9-55
MISCELLANEOUS COMMANDS	9-56
Display EFS or %EFS Result	9-56
Beep	9-56
Display On/Off	9-56
Instrument Special Option Query	9-57
FRAME HIERARCHY CONFIGURATION COMMANDS	9-58
Spare International Bits Set-Up	9-58
E-Bits Set-Up	9-58
Spare National Bits Set-Up	9-58
Spare CRC4 NFAS Frame A-bits Codeword	9-59
Codeword Into NFAS Frame Bit Number	9-59
Codeword Into NFAS Frame Bit Enable	9-60
CAS Multiframe Bits Set-Up	9-60
CAS Multiframe ABCD Bits Set-Up	9-60
CAS Multiframe Service Bits (704 kb/s) Set-Up	9-61
Deselected Timeslots Pattern	9-61
Sub Rate X.50 DIV 2 FAS Bits Set-Up	9-61
Sub Rate X.50 DIV 3 FAS Bits Set-Up	9-62
Sub Rate X.58 Service Octets Set-Up	9-62
User Defined X.53 Mapping	9-62
X.53 Mapping Standard	9-64

ALARM GENERATION, ERROR ADDITION AND FRAME	
SIMULATION COMMANDS	9-66
Alarm Generation	9-66
Error Add Type	9-66
Error Add	9-67
Error Add Ratio	9-67
Sub Rate Burst Error Length	9-67
Frame Simulate Test Type	9-68
Frame Simulate Test Error Mode	9-68
Frame Simulate Burst Error Length	9-69
Frame Simulate User Defined Burst Length	9-69
Burst Error Start/Stop	9-69
Continuous Frame Error Add	9-70
User Defined Continuous Frame Error Add	9-70
TEST PERIOD AND RESULTS CONFIGURATION	
COMMANDS	9-72
Test Period Type	9-72
Timed start, date and time	9-72
Test Period Duration	9-73
User Defined Test Period	9-74
Results Display Control	9-74
Timeslot Result Display	9-74
Sub Rate Monitor Result Display	9-75
Timeslot Selection For Data and Signaling	9-76
Timeslot Signaling Selection - All or Single	9-76
Timeslot NFAS Display Event Capture Mode	9-76
Timeslot NFAS Display Latch Mask	9-77
Sub Rate Monitor Octet Number	9-77
Sub Rate FAS Word Monitor For X.58	9-77
Sub Rate Service Bits Monitor For X.58	9-78
Analysis Measurement Type	9-78
Analysis Threshold Type	9-78
SES Analysis Threshold	9-79
Degraded Minutes Analysis Threshold	9-79
Alarm Mask Register	9-80
RESULT QUERY COMMANDS	9-81
Bit Error Result Query	9-81
Code Error Result Query	9-82

Frame Error Result Query	9-82
CRC Error Result Query	9-83
REBE Error Result Query	9-83
Analysis Measurement Parameters Query	9-84
Bit Analysis Result Query	9-84
Frame Analysis Result Query	9-85
CRC Analysis Result Query	9-85
REBE Analysis Result Query	9-86
Alarm Seconds Result Query	9-86
Frequency Result Query	9-87
Round Trip Delay Query	9-88
COFA Result Query	9-88
Pattern Slips Result Query	9-89
Tone Frequency Result Query	9-89
Tone Level Result Query	9-89
Elapsed Time Result Query	9-89
Timeslot Monitor Query	9-90
Timeslot Monitor All Signaling Bits Query	9-90
Timeslot Monitor All NFAS Bits Query	9-91
Timeslot Monitor NFAS Latch Query	9-91
Timeslot Monitor NFAS Latch Timestamp Query	9-91
Alarm Change Status Query	9-92
Alarm Status Query	9-92
Multiple Timeslot Transmit and Receive Bandwidth	9-93
M.2100 results query	9-93
M.2110 pass/fail query	9-94
M.2120 report count query	9-94
Slip (estimated) Result Query	9-94
Peak Wander Result Query	9-95
STORED MEASUREMENT AND GRAPHICS COMMANDS	9-96
Store Measurement Results Enable	9-96
Store Size and Usage	9-96
Detailed Store Use Query	9-97
Delete All SMG Stores	9-98
Delete One SMG Store	9-98
Stored Graphical Data Query	9-99
Stored Graphical Data in Compressed Form Query	9-101
Stored Application Mode Query	9-103

Stored Interface Type Query	9-103
Stored Ternary Linecode Query	9-103
Stored Bearer Rate Query	9-103
Stored Framing Type Query	9-103
Stored Pattern Type Query	9-104
Stored PRBS Polarity Query	9-104
Stored User Defined Word Pattern Query	9-104
Stored Long User Word Number Query	9-104
Stored Sub Rate Circuit Number Query	9-105
Stored Tone Frequency Query	9-105
Stored User Defined Tone Frequency Query	9-105
Stored Tone Level Query	9-105
Stored Receiver Multiple Timeslot Selection Query	9-105
Stored Receiver Single Timeslot Query	9-106
Stored Sub Rate Bearer Timeslot Query	9-106
Stored Sub rate Channel Number	9-106
Stored Bit Error Result Query	9-106
Stored Code Error Result Query	9-107
Stored Frame Error Result Query	9-107
Stored CRC Error Result Query	9-108
Stored REBE Error Result Query	9-108
Stored Bit Analysis Measurement Parameters Query	9-109
Stored Bit Analysis Result Query	9-109
Stored Frame Analysis Result Query	9-110
Stored CRC Analysis Result Query	9-111
Stored REBE Analysis Result Query	9-111
Stored Alarm Seconds Result Query	9-112
Stored Elapsed Time Result Query	9-113
Stored M.2100 results query	9-113
Stored M.2110 pass/fail query	9-114
Stored M.2120 report count query	9-114
Stored Slip (estimated) Result Query	9-114
Stored (peak) Wander Result Query	9-115
Default Conditions	9-116
Status Registers	9-120
STATUS REGISTER A	9-120
STATUS REGISTER B	9-123
READY REGISTER	9-125

ALARM REGISTER	9-126
HP-IB Operation	9-128
Connecting to the HP-IB	9-128
Operating Distances	9-129
Hewlett-Packard Interface Bus Connector	9-129
Suitable Cables	9-130
Connection Over Greater Distances	9-131
Setting Up for Printing or Controlling	9-131
To Print using Talk Only	9-131
To Control the Instrument Remotely	9-131
Communication with the System Controller	9-131
HP-IB Address Selection	9-132
To Return to Local Operation	9-132
Status Reporting	9-132
Service Request Interrupt Routine	9-133
Poll Using STB?	9-133
HP-IB Capability	9-133
HP-IB Universal Commands	9-134
Error Codes	9-136
Common Capability Errors	9-136
Parse Time Errors (Error codes -100 to -199)	9-136
Execution Time Errors (Error codes -200 to -299)	9-137
Stored Measurement Results and Graphics Errors (Error codes -410 to -499)	9-137
Option or Capability Errors (Error codes -600 to -699)	9-137
Self-Test Errors (Error codes 1 to 15999)	9-138

Index

Figures

9-1. HP-IB Connections and Logic Levels	9-130
---	-------

Tables

9-1. HP-IB Interconnecting Cables	9-13
9-2. HP-IB Interconnecting Cables	9-130



What the Digital Telecom Analyzer gives you.

- Fast and easy, installation and maintenance of X.58, X.50 div 2, X.50 div 3 and X.50 BIS sub rates, 64, 704, 2048 and 8448 kbit/s CEPT digital circuits and services with a lightweight (under 10lbs), field-portable and rugged test set.
 - Out-of-service testing for installation and commissioning.
 - In-service testing for maintenance and troubleshooting.
- Only one easy-to-use box, to buy, carry and learn.
- Measure all error types simultaneously, including CRC4 frame errors.
- Make error performance measurements conforming to CCITT Rec. G.821.
- Check multiplexers fast - with flexible frame error simulation and transhierarchical capability.
- Check digital cross connects and multiplexers - with $n \times 64$ kbit/s testing. Load up switch inputs with test patterns in 1, n or all 31 timeslots. Measure errors at the output in any timeslot(s). Select the timeslot(s) you want or use fast set up for 1 to 1 mapping.
- No need to carry a printer.
 - Results are stored for future analysis.
 - Long-term test interpretation at-a-glance with graphic, on-screen presentation of results.
- Correlate error bursts and alarm conditions - graphic presentation of errors and alarms simultaneously.
- No need to run several tests or step through results to find out what's wrong - "trouble scan" looks for bit, code and frame errors.
- Mux/demux VF or data signals in any timeslot - with built-in VF channel access.
 - Talk/listen using the speaker/microphone
 - Plug in a TIMS or protocol analyzer
- Easy circuit identification - check if channels are idle and make channel performance measurements.

- See signaling bits, multiframing bits and timeslot content - using timeslot monitor.
- Add datacom and BER/BLER - the HP 15901A Datacom Module extends the telecom analyzer to provide datacom testing for lasting value and protection of the your investment in test equipment.
- Easy integration into network monitoring or manufacturing test systems - RS-232 remote control.

Getting Started

This chapter tells you about the basic features of the instrument and shows you how to use them. The items covered are:

- Switching on
- Setting the analyzer to a known state
- Making a measurement
- Adding errors
- Observing alarm indications
- Displaying alarm history
- Displaying results in tabular form.
- Displaying results as graphs

Before Getting Started

Connect the instrument to a power supply of between 86 V ac and 260 V ac. If in doubt see “Installation” in chapter 7.

Getting Started

Switch On

Switch on.

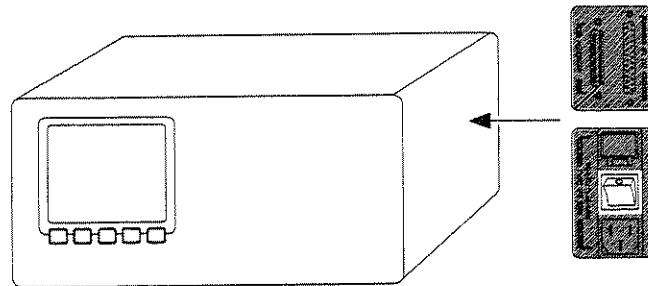

You should see.

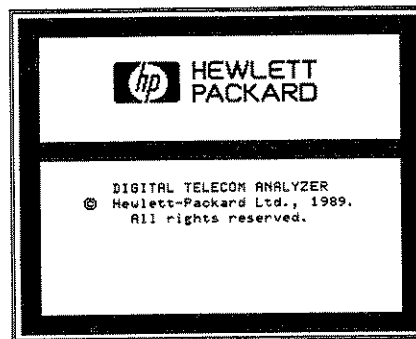

Followed by.

If the analyzer is part of a combined telecom/datacom test set, set the datacom module TEST SELECT to Telecom.

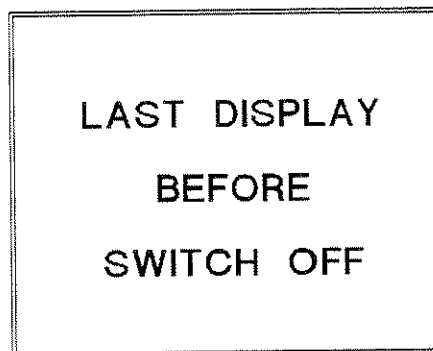

To Set the Analyzer to a Known State

The analyzer can store 1 fixed and 5 user selectable test set-ups. Recall the fixed (2Mbit/s Tx and Rx) set-up as follows:

Press **OTHER**

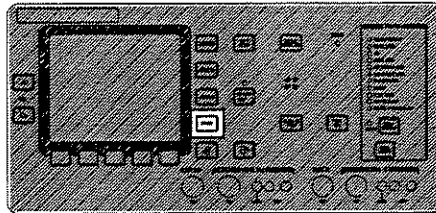

You should see one of the **FUNCTION** displays with **FUNCTION** highlighted.

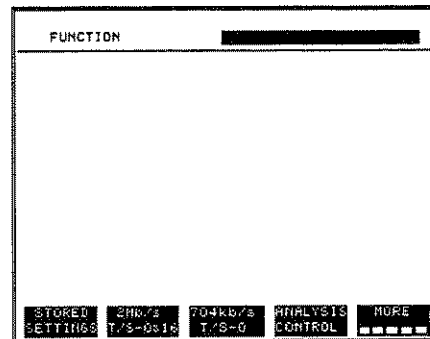



Select **STORED SETTINGS**

NOTE :

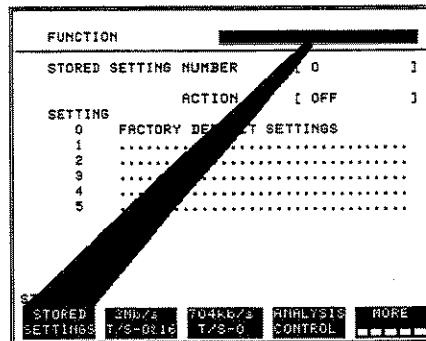
The instrument starts up in the "last used" state. Some of the settings in this procedure may already be selected.



Use  and  to highlight
 STORED SETTING NUMBER [0]

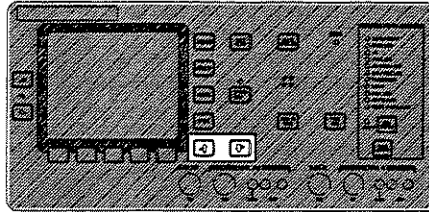

Select **0**.

0 is the fixed stored setting.

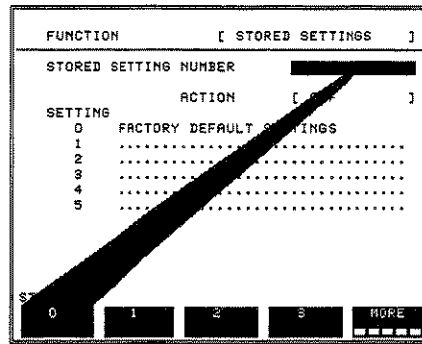

Highlight ACTION [RECALL].

Select **RECALL**.

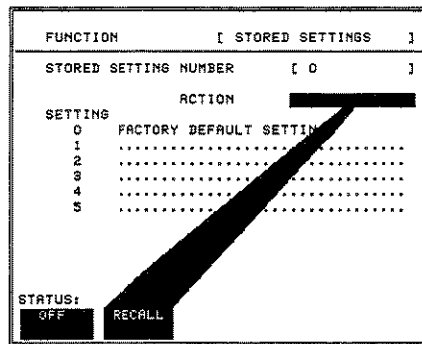

1-4 Getting Started

To Choose EFS or %EFS as the Current Results Display

During a test EFS or %EFS can be displayed. Printouts and stored results show both EFS and %EFS.

Press **OTHER**

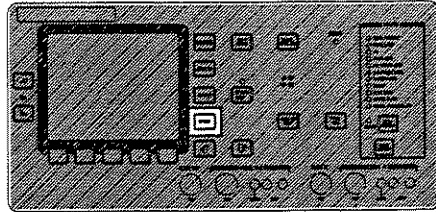

Highlight
DISPLAY EFS OR %EFS []

Select **EFS**

FUNCTION		
KEYBOARD LOCK	[OFF]
BEEP ON ERROR	[OFF]
DESELECTED TIMESLOTS	[2^6-1]
DISPLAY EFS OR %EFS	[%EFS]

STATUS:
 ANALYSIS CONTROL LOGS USE BORD MISCELLANEOUS RS232 PORT MORE

You should see

FUNCTION		
KEYBOARD LOCK	[OFF]
BEEP ON ERROR	[OFF]
DESELECTED TIMESLOTS	[2^6-1]
DISPLAY EFS OR %EFS	[EFS]

STATUS:
 EFS %EFS

To Loop Transmit/Receive and Make a Measurement

Connect
SIGNAL OUT to SIGNAL IN.
Check that the signal is being received
(green SIGNAL PRESENT indicator on).

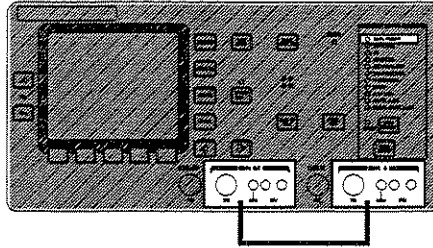

Press **RESULTS** and select

BER MEASUREMENTS

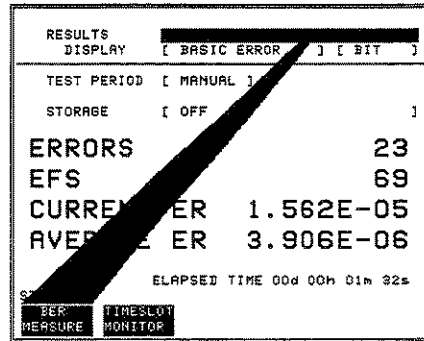

Highlight **STORAGE** []

Select **1 MIN RESOL'N**

This enables the display

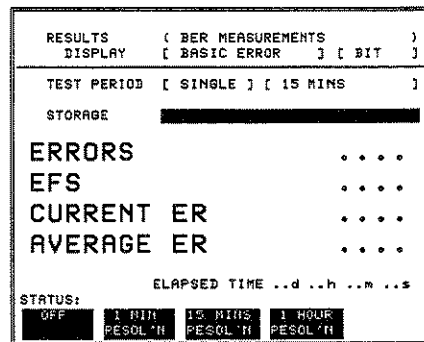

Press **START/STOP** to start a test.

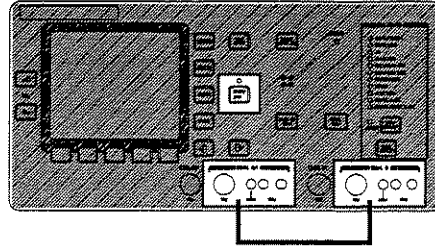

Highlight **DISPLAY** [**BER MEASUREMENTS**].

Select **BASIC ERROR**.

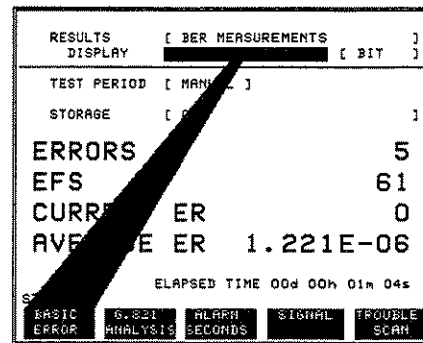

Watch the **ERRORS** indicator flash and the results display accumulate errors when you press **SINGLE ERROR ADD** a few times.

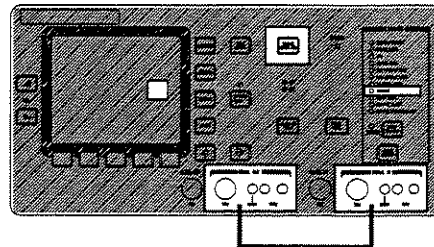

To Add Errors at a Fixed Rate

Press **SETTINGS**. Use **↓** and **→** to highlight **SINGLE** and select **RATE**.

```

APPLICATION [ 2Mb/s ]
INTERFACE [ TERNARY ] LINECODE [ HDB3 ]
FRAME (6.704) [ CAS MFM ]
THROUGH MODE [ OFF ]
TX CLOCK SOURCE [ INTERNAL ]

PATTERN [ 2^15-1 ]

RECEIVE TIMESLOT [ AS PER TX ]
Tx [ F*.....S..... ]
0 |-----| 31
Bandwidth 64kb/s

ALARM GEN [ 0 ]
ERROR ADD [ BIT ]
STATUS:
SINGLE
ENABLE
    
```

Highlight **ERROR ADD [BIT] [RATE] []**.

Use **MORE** to display more selections.

Select **1E - 5**

```

APPLICATION [ 2Mb/s ]
INTERFACE [ TERNARY ] LINECODE [ HDB3 ]
FRAME (6.704) [ CAS MFM ]
THROUGH MODE [ OFF ]
TX CLOCK SOURCE [ INTERNAL ]

PATTERN [ 2^15-1 ]

RECEIVE TIMESLOT [ AS PER TX ]
Tx [ F*.....S..... ]
0 |-----| 31
Bandwidth 64kb/s

ALARM GENERATION [ 0 ]
ERROR ADD [ BIT ]
STATUS:
1E-0 1E-3 1E-4 1E-5 MORE
    
```

Press **RESULTS**, you will see the current error ratio ($1.562E - 05$) and the average error ratio since you started the test.

You can choose to display EFS or %EFS here by using **OTHER MISCELLANEOUS**.

```

RESULTS [ BER MEASUREMENTS ]
DISPLAY [ BASIC ERROR ] [ BIT ]

TEST PERIOD [ MANUAL ]

STORAGE [ OFF ]

ERRORS 23
EFS 69
CURRENT ER 1.562E-05
AVERAGE ER 3.906E-06

ELAPSED TIME 00d 00h 01m 32s

STATUS:
BER MEASURE
TIMESLOT MONITOR
    
```

To See Alarm Indicator Operation

Break the signal path.

You should see the alarm indication for SIGNAL LOSS.

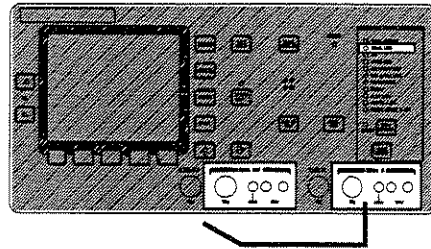

To See an Alarm Record

Reconnect the signal path.

As alarms have occurred in the current test, you should see the HISTORY indicator on.

Press and hold **SHOW HISTORY** to see what they were.

You can use this to check for the occurrence of alarms on unattended tests.

Release **SHOW HISTORY**.

Press **RESET HISTORY**.

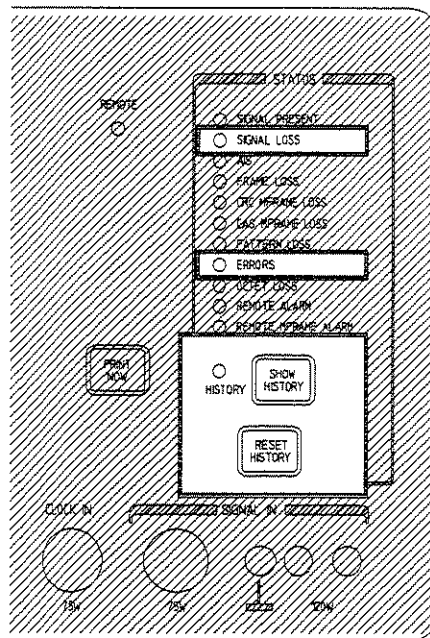

To See Results

Highlight DISPLAY [2].

Select G.821 ANALYSIS.

RESULTS	[BER MEASUREMENTS]			
DISPLAY	[BIT]			
TEST PERIOD	[MANUAL]			
STORAGE	[OFF]			
ERRORS	5			
EFS	61			
CURRENT	0			
AVERAGE	1.221E-06			
ELAPSED TIME 00d 00h 01m 04s				
STATUS:				
BASIC	G.821	ALARM	SIGNAL	TROUBLE
ERROR	ANALYSIS	SECONDS		SCAN

You should see.

RESULTS	[BER MEASUREMENTS]			
DISPLAY	[G.821 ANALYSIS] [BIT]			
TEST PERIOD	[MANUAL]			
STORAGE	[OFF]			
G.821 fixed thresholds used				
UNAVAILABILITY	58 19.20580%			
ERRORED SECONDS	122 50.00000%			
SEVERELY ERRORED SECS	4 1.63934%			
DEGRADED MINUTES	3 75.00000%			
LTMR	7.682E-06			
ELAPSED TIME 00d 00h 05m 02s				
STATUS:				
BASIC	G.821	ALARM	SIGNAL	TROUBLE
ERROR	ANALYSIS	SECONDS		SCAN

Select **ALARM SECONDS**.

Simulate power loss by switching the analyzer off and on again.

You should see.

RESULTS DISPLAY	[BER MEASUREMENTS]]
	[ALARM SECONDS]	
TEST PERIOD [MANUAL]		
STORAGE	[OFF]]
POWER LOSS		10
SIGNAL LOSS		16
AIS		0
FRAME LOSS		0
CAS MFRAME LOSS		0
PATTERN LOSS		0
REMOTE ALARM		0
REMOTE MFRAME ALARM		0
ELAPSED TIME 00d 00h 01m 29s		
STATUS:		
BASIC ERROR	6.821 ANALYSIS	ALARM SECONDS
		SIGNAL
		TROUBLE SCAN

Select **SIGNAL**.

RESULTS DISPLAY	[BER MEASUREMENTS]]
	[SIGNAL]	
TEST PERIOD [MANUAL]		
STORAGE	[OFF]]
BIT	CODE	FRAME
58	155	95
ELAPSED TIME 22m 03s		
STATUS:		
BASIC ERROR	6.821 ANALYSIS	ALARM SECONDS
		SIGNAL
		TROUBLE SCAN

You should see.

RESULTS DISPLAY	[BER MEASUREMENTS]]
	[SIGNAL]	
TEST PERIOD [MANUAL]		
STORAGE	[OFF]]
RX FREQUENCY		2048000 Hz
RX FREQUENCY OFFSET		+0 ppm
UNCONTROLLED SLIPS (COFA)		2
CONTROLLED SLIPS (PATTERN)		
POSITIVE		0
NEGATIVE		0
ELAPSED TIME 00d 00h 01m 52s		
STATUS:		
BASIC ERROR	6.821 ANALYSIS	ALARM SECONDS
		SIGNAL
		TROUBLE SCAN

To See Results as Graphs

Press **GRAPHS**.

Display graphs of ALARMS and BIT ERROR COUNT using **CHANGE UPPER** and **CHANGE LOWER**.

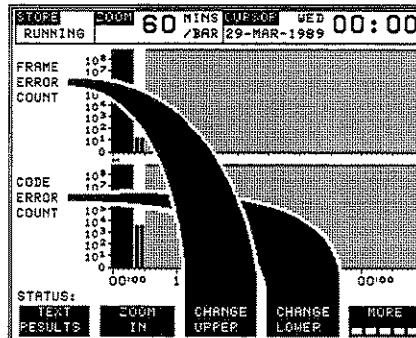

You should see.

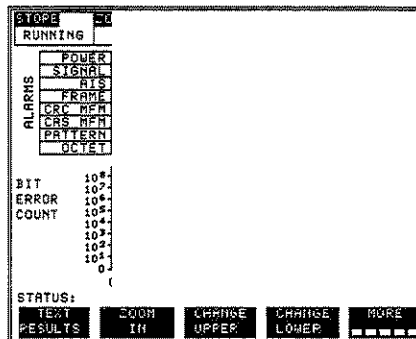

Move the cursor (between the graphs) to the time of interest using **←** and **→**.

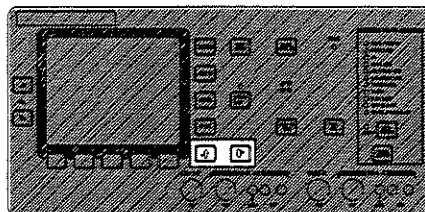

The CURSOR box shows the cursor start time.

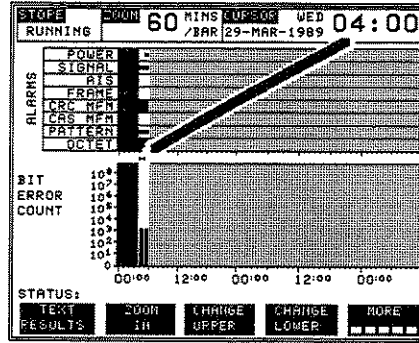

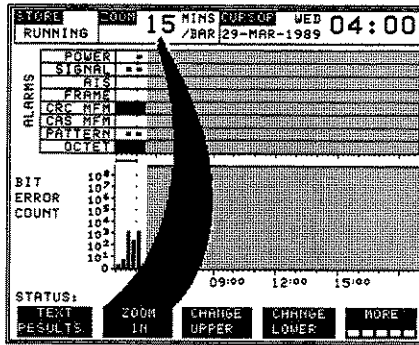

Select the resolution you want with ZOOM IN/OUT.

The ZOOM box shows you the resolution.

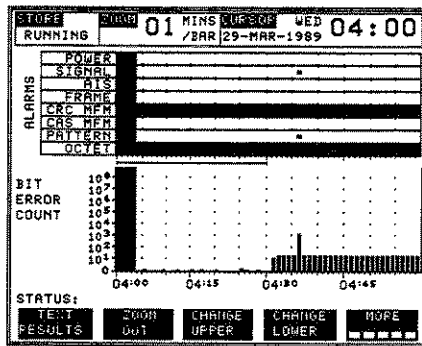

You can see the alarms and errors where you disconnected the power signal.



Display a different time period using  and 

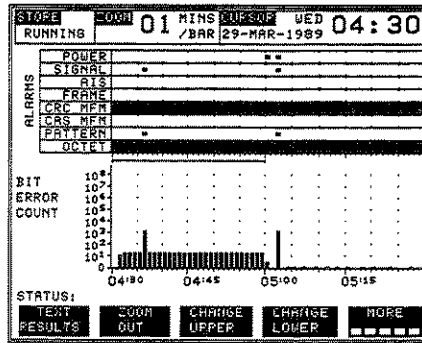

To stop the test press **START/STOP**

After Getting Started

Now that you are familiar with the operation of the analyzer and are able to make the basic measurements, it's time to explore.

To look at the timeslot content, press **RESULTS** and change from BER MEASUREMENT to TIMESLOT MONITOR.

To see some of the other things that you can do, press **OTHER**.

To see how you can choose analysis thresholds, select **ANALYSIS CONTROL**.

To see how you can select framing and signaling bits, select **2Mb/s T/S 0 & 16** and, if you have option 003, **704kb/s T/S 0**.

Select **MISCELLANEOUS** and see how to select the content of the background timeslots, use the keyboard lock and have the analyzer beep on errors.

See how to find stored results. Use **GRAPHS**, **TEXT RESULTS** and **STORED RESULTS**.



Getting Ready for Telecom Testing

This chapter shows you how to use facilities which apply to the telecom tests described in chapter 3. Check to see if you want to do any of the things in the following list. If not go on to chapter 3 Telecom Testing.

- Selecting telecom on combined telecom/datacom test sets.
- Releasing keyboard lock.
- Fast Set up.
- Recalling stored set-ups.
- Setting long user words.
- Storing results.
- Selecting a test period.
- Setting framing and signalling bits.
 - For 2Mbit/s operation.
 - For 704kbit/s operation.
- Setting analysis thresholds.
 - Setting standard or annex D (64 kb/s equivalent) thresholds.
 - Setting your own thresholds.
- Setting the content of background timeslots
- Setting binary clock/data phase.
- Storing test set-ups.
 - Indicating stored setup content.
- Setting the date and time.
 - Restarting the clock.
- Setting audible indication of errors
- Communicating over the test line
- Setting the start time for a timed start measurement
- Setting for result printing at timed intervals
- Setting BIS M.2100 thresholds
- M.2120 TR2 Factor selection

To Select Telecom on Combined Telecom/Datacom Test Sets

If the telecom analyzer is part of a combined Telecom/Datacom Test Set, set the Datacom module TEST SELECT to Telecom.

To Release Keyboard Lock

The keyboard lock prevents change of SETTINGS but allows change of RESULTS / GRAPHS.

Press **OTHER**.

Select **MISCELLANEOUS**.

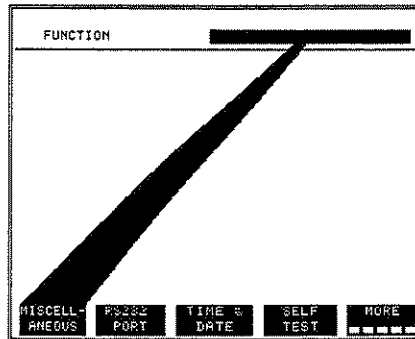

Highlight **KEYBOARD LOCK** [**]**.

Select **OFF**.

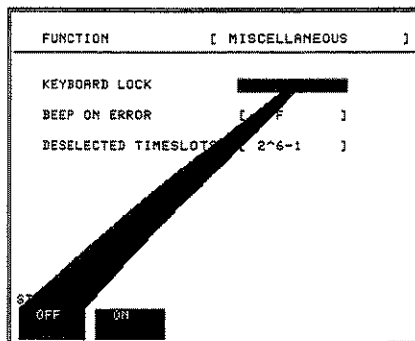

2-2 Getting Ready for Telecom Testing

Fast Set Up

There are five ways to set up the telecom analyzer :

1. Automatically setting frame, code and pattern to the incoming signal.
2. Recalling stored set-ups.
3. Recalling stored set-ups and modifying them.
4. Manually from the front panel (see Chapter 3 Telecom Testing).
5. Over an RS-232 link (see Chapter 9 Remote Control).

To Automatically Set Frame, Code and Pattern To The Incoming Signal

Press **SETTINGS**

Select the rate of the incoming signal.

Press **AUTO SETUP**

For successful pattern detection, the pattern must be in: "all timeslots", or in timeslots selected on **SETTINGS** display.

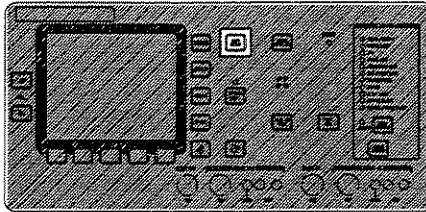

To Recall A Stored Set-Up

Press **OTHER**.

Select **STORED SETTINGS**.

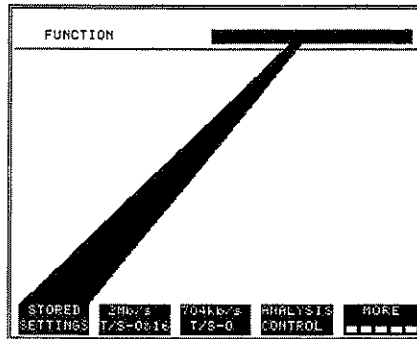

Highlight
STORED SETTING NUMBER [1]

and select the set-up you want.

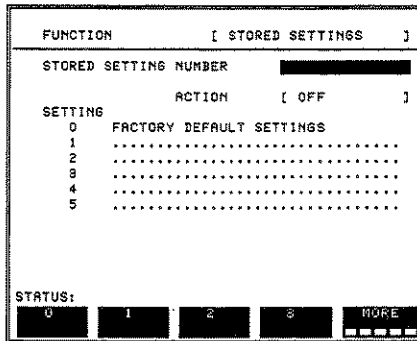

Highlight ACTION [OFF]

Select **RECALL**.

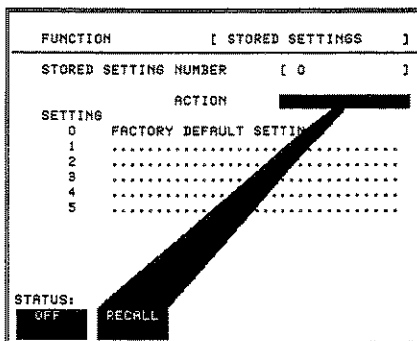

To Set Up For Storage of Results

To see the storage space available before overwriting occurs.

Use **GRAPHS**, **TEXT RESULT**,
STORE STATUS

100% = 32 hours at 1 minute resolution.
20 days at 15 minute resolution.
80 days at 1 hour resolution.

STORE	START DATE	START TIME	TEST DURATION	STORE USE
-9T	30-MAR-1989	04:26	00d 00h 01m	<1%
-8T	2-APR-1989	03:07	00d 00h 01m	<1%
-7T	2-APR-1989	03:08	00d 00h 01m	<1%
-6T	2-APR-1989	03:09	00d 00h 01m	<1%
-5T	2-APR-1989	03:09	00d 00h 01m	<1%
-4T	2-APR-1989	03:10	00d 00h 01m	<1%
-3T	2-APR-1989	03:10	00d 00h 02m	<1%
-2T	2-APR-1989	04:39	00d 00h 03m	<1%
-1T	2-APR-1989	04:42	00d 00h 01m	<1%
DEMO	4-APR-1989	04:49	00d 01h 47m	5%
TOTAL USED			00d 01h 59m	6%
TOTAL FREE			01d 08h 09m	94%

STATUS:
GRAPH RESULTS **TEXT RESULTS** **DELETE STORE** **DELETE ALL**

Press **RESULTS**.

Select **BER MEASUREMENTS**.

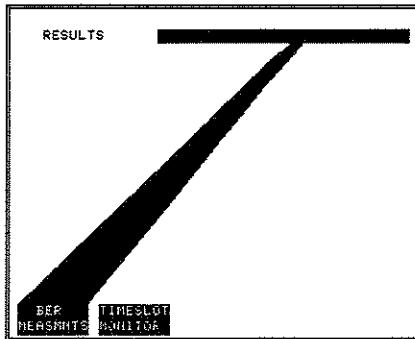

Highlight **STORAGE** [].

Select the storage resolution you want.

RESULTS	[BER MEASUREMENTS]
DISPLAY	[BASIC ERROR] [BIT]
TEST PERIOD	[MANUAL]
STORAGE	[]
ERRORS
EFS
CURRENT ER
AVERAGE ER
ELAPSED TIME ..d ..h ..m ..s	
STATUS:	
OFF	[1 MIN RESOL'N] [15 MINS RESOL'N] [1 HOUR RESOL'N]

To Set Up Long User Words

You may select and store up to four words of up to 128 bytes. For high error conditions you may select sync on any number of bytes.

Press **OTHER**.

Select **LONG USR WORD**.

```

FUNCTION          [ STORED SETTINGS ]
-----
STORED SETTING NUMBER [ 0 ]
ACTION              [ OFF ]

SETTING
0  FACTORY DEFAULT SETTINGS
1  .....
2  .....
3  .....
4  .....
5  .....

STATUS:
ANALYSIS CONTROL  LONG USR WORD  MISCELL ANEIOUS  RS232 PORT  AURE

```

Highlight **BYTE LENGTH** [] and select the number of bytes you want in the pattern.

Highlight **SYNC ON** [] and select the number of error free bytes you want the T1 Tester to sync on.

Highlight **LEFT HAND BIT SENT** [] and select **FIRST** to transmit the bits as displayed, or **LAST** to transmit bits in the reverse order.

```

FUNCTION          [ LONG USER WORD ]
-----
USER WORD NUMBER  [ 1 ]
BYTE LENGTH       [ 128 ]
SYNCHRONISATION LENGTH [ USER PROGRAM ]
SEND LEFT HAND BIT [ FIRST ]
1-16 [ 8080C0808080008080808080C08080 ]
17-32 [ 8080E0808080808080808080808080 ]
33-48 [ 808080808080808080808080808080 ]
49-64 [ 8001800180018088FFFFFFFFFFFFFF ]
65-80 [ 555555555555555577777777777777 ]
81-96 [ EEEEEEEEEEEEEEE666666666666666 ]
97-112 [ 999999999999999944444444444444 ]
113-128 [ FFFFFFFFFFFFFFFFFFFFFFFFFFFFFFFF ]

STATUS:
FIRST  LAST

```

To change a byte

Highlight each of the two hexadecimal characters for that byte and select the byte you want. The binary value is shown at the bottom of the display.

Select **SET-UP**.

```

FUNCTION          [ LONG USER WORD ]
-----
USER WORD NUMBER  [ 1 ]
BYTE LENGTH       [ 128 ]
SYNCHRONISATION LENGTH [ USER PROGRAM ]
SEND LEFT HAND BIT [ FIRST ]
1-16 [ 8080C0808080008080808080C08080 ]
17-32 [ 8080E0808080808080808080808080 ]
33-48 [ 808080808080808080808080808080 ]
49-64 [ 8001800180018088FFFFFFFFFFFFFF ]
65-80 [ 555555555555555577777777777777 ]
81-96 [ EEEEEEEEEEEEEEE666666666666666 ]
97-112 [ 999999999999999944444444444444 ]
113-128 [ FFFFFFFFFFFFFFFFFFFFFFFFFFFFFFFF ]
Cursor On Byte #105 ( 01000100 )

STATUS:
DECREASE INCREASE COPY TO
DIGIT     DIGIT     END LINE  ←  →

```

To Set a Test Period

Press **RESULTS**.

Select **BER MEASUREMENTS**.

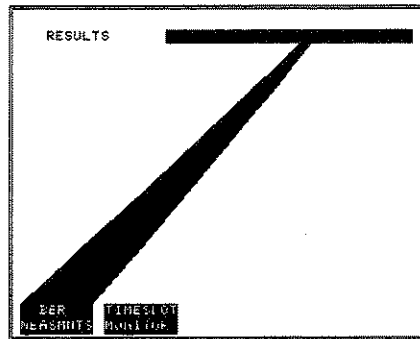

Highlight
TEST PERIOD [].

Select **SINGLE**.

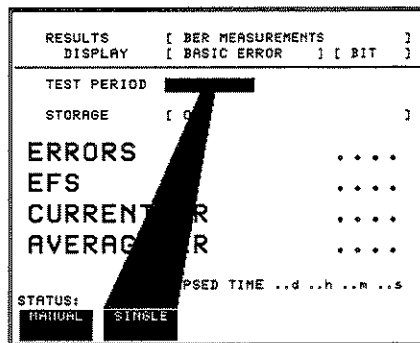

Highlight
TEST PERIOD SINGLE [15 MINS].

Select the test period you want.

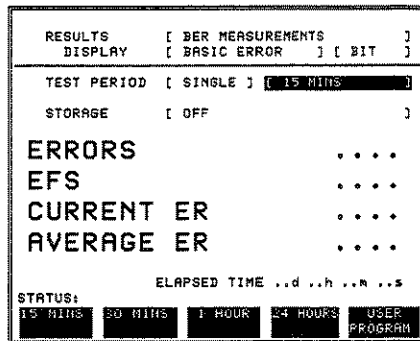

To Set Framing and Signaling Bits

For 2Mbit/s Operation

Press **OTHER**.

Select **2Mb/s T/S - 0&16**.

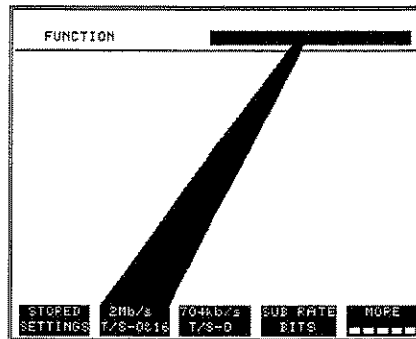

Highlight the bits you want to change.

Use **→**, **←**, **SET 0** and **SET 1** to select the bits you want.

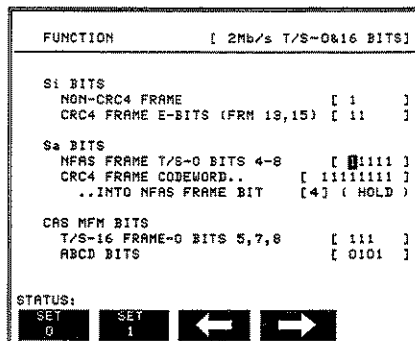

For 704kbit/s Operation

Press **OTHER**.

Select **704kb/s T/S - 0**.

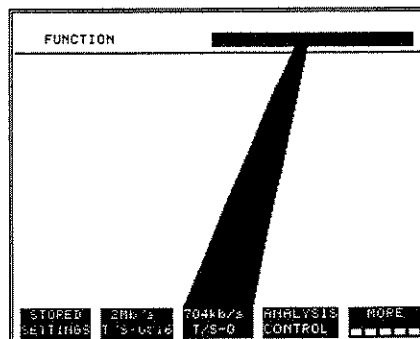

Highlight the bits you want to change.

Use **→**, **←**, **SET 0** and **SET 1** to select the bits you want.

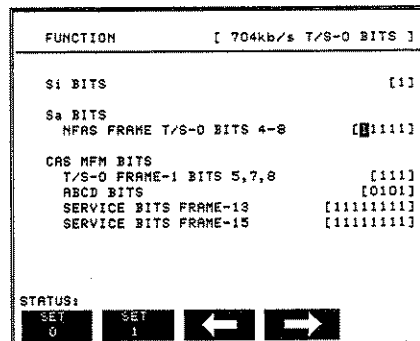

To Set Analysis Thresholds

To Select Standard Annex D Thresholds

Press **OTHER**.

Select **ANALYSIS CONTROL**.

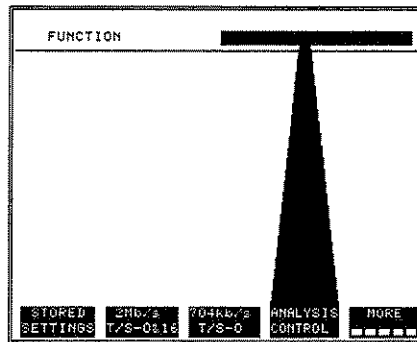

Highlight **ANALYSIS TYPE** [].

For standard thresholds select **G.821 STANDARD**.

For thresholds normalised to 64kbit/s equivalent, select **G.821 ANNEX-D**.

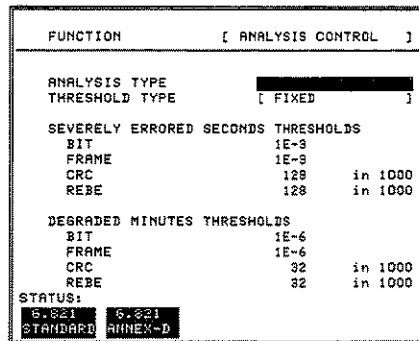

To Select Your Own Thresholds.

Press **OTHER**.

Select **ANALYSIS CONTROL**.

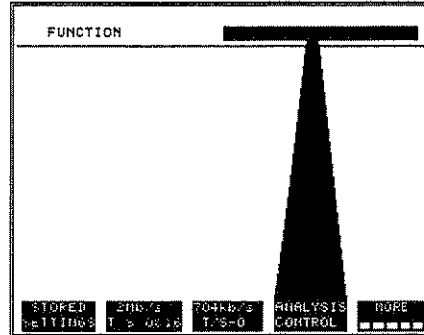

Highlight **THRESHOLD TYPE** [].

Select **USER PROGRAM**.

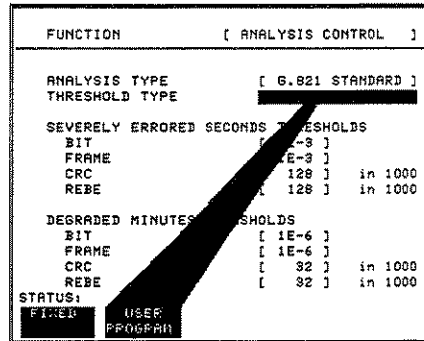

Highlight the group of bits you want to change.

Use **1E - n** or **→**, **←**
INCREASE DIGIT and **DECREASE DIGIT**
to select the values you want.

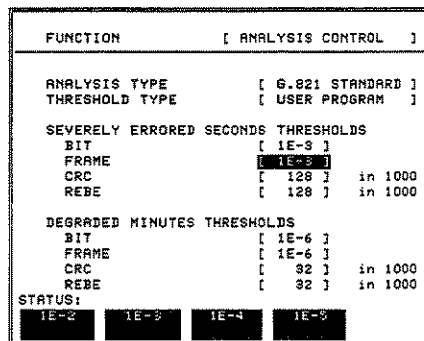

To Set the Content of Background Timeslots

Press **OTHER**.

Select **MISCELLANEOUS**.

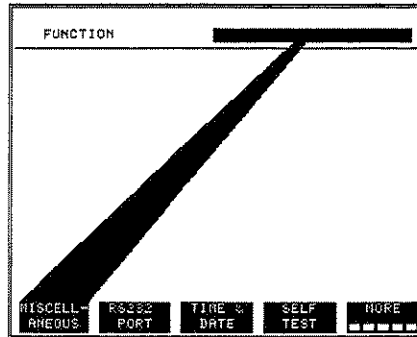

Highlight
DESELECTED TIMESLOTS [**1**].

Select **ALL ONES** or $2^6 - 1$

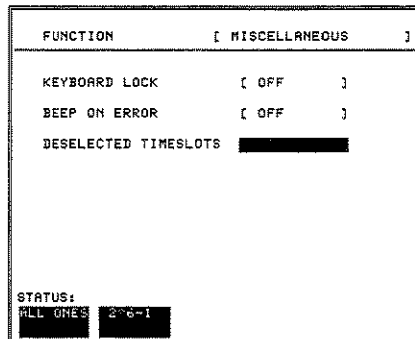

To Choose EFS or %EFS as the Current Results Display

During a test EFS or %EFS can be displayed. Printouts and stored results show both EFS and %EFS.

Press **OTHER**.

Select **MISCELLANEOUS**.

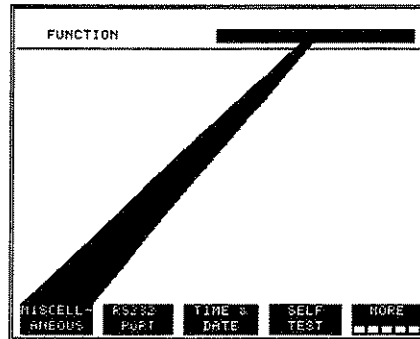

A screenshot of a terminal window showing a menu titled "FUNCTION". The menu items are: MISCELLANEOUS, RS232 PORT, TIME & DATE, SELF TEST, and NONE. The "MISCELLANEOUS" option is highlighted with a thick black bar.

Highlight
DISPLAY EFS OR %EFS []

Select the form you want to display.

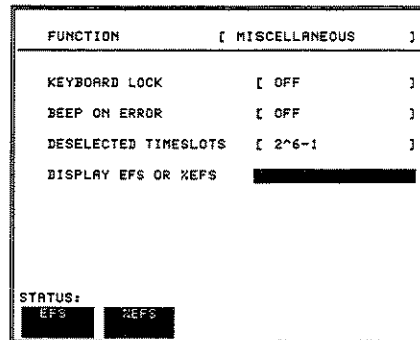

A screenshot of a terminal window showing the "MISCELLANEOUS" menu. The menu items are: KEYBOARD LOCK [OFF], BEEP ON ERROR [OFF], DESELECTED TIMESLOTS [2^6-1], and DISPLAY EFS OR %EFS. The "DISPLAY EFS OR %EFS" option is highlighted with a thick black bar. At the bottom, there is a "STATUS:" section with two options: EFS and %EFS.

To Select Sub rate Bits and Mapping

You may select X.50 div 2 FAS bits, X.50 div 3 FAS bit A and the X.58 service octet contents. You may also select the X.53 mapping and phasing (contiguous or interleaved).

Press **OTHER**.

Select **SUB RATE MISC.**

FUNCTION	[SUB RATE MISC.]
[SUB RATE BITS]	
X.50 div 2 FAS BITS A-H	[11100110]
X.50 div 3 FAS BIT A	[1]
X.58	
SERVICE OCTET T1, BITS A-H	[11111111]
SERVICE OCTET T2	[11111111]
SERVICE OCTET T3	[11111111]
SERVICE OCTET T4	[11111111]
STATUS:	
STORED	2Mbps
SETTINGS	T/S=0&16
	T/S=0
	SUB RATE
	MISC
	MORE

You can select SUB RATE BITS and X.53 MAPPING

FUNCTION	[SUB RATE MISC.]
[SUB RATE BITS]	
X.50 div 2 FAS BITS A-H	[11100110]
X.50 div 3 FAS BIT A	[1]
X.58	
SERVICE OCTET T1, BITS A-H	[11111111]
SERVICE OCTET T2	[11111111]
SERVICE OCTET T3	[11111111]
SERVICE OCTET T4	[11111111]
STATUS:	
SUB RATE	X.53
BITS	MAPPING

The X.53 mapping allows selection of the rate code (the second digit of the definition code).

FUNCTION	[SUB RATE MISC.]
[X.53 MAPPING]	[USER DEFINED]
XYZZ	
X: X.53 division (80/20 frame size)	
Y: X.53 rate code	
Z: X.53 circuit start octet	
0[NONE]	
1[NONE]	
2[NONE]	
3[600 b/s]	
4[2400 b/s]	
5[4800 b/s]	
6[9600 b/s]	
7[14400 b/s]	14400 & 19200 b/s
8[19200 b/s]	CONTIGUOUS
9[NONE]	[PHASES 1&2, 3&4]
STATUS:	
NONE	600b/s 1200b/s 3400b/s NONE

You may select contiguous or interleaved (the third and fourth digits of the definition code).

FUNCTION	[SUB RATE MISC.]
[X.53 MAPPING]	[USER DEFINED]
XYZZ	
X: X.53 division (80/20 frame size)	
Y: X.53 rate code	
Z: X.53 circuit start octet	
0[NONE]	
1[NONE]	
2[NONE]	
3[600 b/s]	
4[2400 b/s]	
5[4800 b/s]	
6[9600 b/s]	
7[14400 b/s]	14400 & 19200 b/s
8[19200 b/s]	CONTIGUOUS
9[NONE]	[PHASES 1&2, 3&4]
STATUS:	
PHASES	PHASES
1&2, 3&4	1&3, 2&4

Select contiguous using phases 1&2 and 3&4

FUNCTION	[SUB RATE MISC.]
[X.53 MAPPING]	[USER DEFINED]
XYZZ	
X: X.53 division (80/20 frame size)	
Y: X.53 rate code	
Z: X.53 circuit start octet	
0[NONE]	
1[NONE]	
2[NONE]	
3[600 b/s]	
4[2400 b/s]	
5[4800 b/s]	
6[9600 b/s]	
7[14400 b/s]	14400 & 19200 b/s
8[19200 b/s]	INTERLEAVED
9[NONE]	[PHASES 1&3, 2&4]
STATUS:	
PHASES	PHASES
1&2, 3&4	1&3, 2&4

Select interleaved using phases 1&3 and 2&4

To Set the Binary Clock/Date Phase

Binary data may be sampled on with the leading or trailing edge of the clock. The example shows the Tx data/clock phase selection.

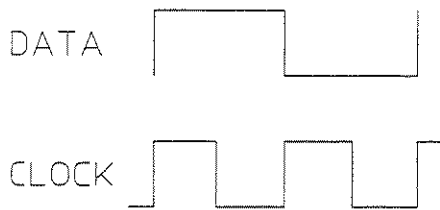

```

APPLICATION [ 2Mb/s ]
INTERFACE [ BINARY ] CLOCK-TX [ 0 ], RX[1]
FRAME (G.704) [ CAS ME ]
THROUGH MODE [ OFF ]
TX CLOCK SOURCE [ INTERNAL ]
PATTERN [ 2^15-1 ]
RECEIVE TIMESLOT [ AS PER TX ]
Tx [ F*.....S..... ]
0 |-----| 31
Bandwidth 64kb/s
ALARM GENERATION [ OFF ]
ERROR ADDRESS ( BIT ) [ SINGLE ]
STATUS:
↑ ↓
    
```

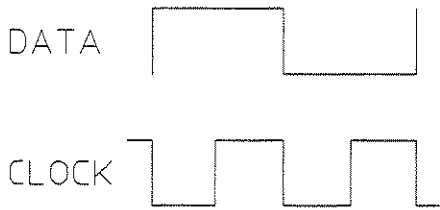

```

APPLICATION [ 2Mb/s ]
INTERFACE [ BINARY ] CLOCK-TX [ 0 ], RX[1]
FRAME (G.704) [ CAS ME ]
THROUGH MODE [ OFF ]
TX CLOCK SOURCE [ INTERNAL ]
PATTERN [ CAS-1 ]
RECEIVE TIMESLOT [ AS PER TX ]
Tx [ F*.....S..... ]
0 |-----| 31
Bandwidth 64kb/s
ALARM GENERATION [ OFF ]
ERROR ADDRESS ( BIT ) [ SINGLE ]
STATUS:
↑ ↓
    
```

To Store Test Set-Ups

Set up the telecom analyzer with the settings you want to store.

Press **OTHER**.

Select **STORED SETTINGS**.

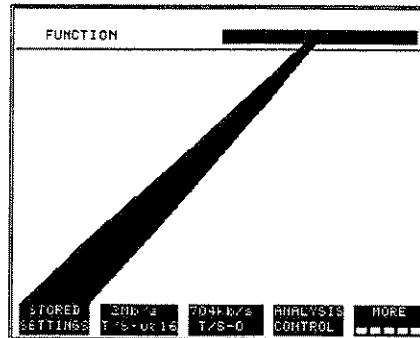

Highlight
STORED SETTING NUMBER []

Select the number of the store you want to use.

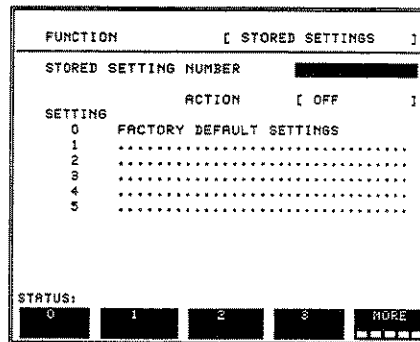

Highlight LOCK []

Select OFF

FUNCTION		[STORED SETTINGS]
STORED SETTING NUMBER	[9]	
LOCK	[OFF]	
ACTION	[OFF]	
SETTING		
0	FACTORY DEFAULT SETTINGS	
1	[.....]	
2	[.....]	
3	[.....]	
4	[.....]	
5	[.....]	

STATUS: OFF ON

Highlight ACTION []

Select SAVE

FUNCTION		[STORED SETTINGS]
STORED SETTING NUMBER	[9]	
LOCK	[OFF]	
ACTION	[OFF]	
SETTING		
0	FACTORY DEFAULT SETTINGS	
1	[.....]	
2	[.....]	
3	[.....]	
4	[.....]	
5	[.....]	

STATUS: OFF RECALL SAVE

To Indicate Stored Set-Up Content

The display area beside the setting number may be used to give the set-up a title or to leave a message for a future user. The title / message may be set remotely, using a terminal connected to the RS-232 connector, (see the "Remote Operation" chapter) or manually as follows :

Highlight LOCK [3].

Select OFF.

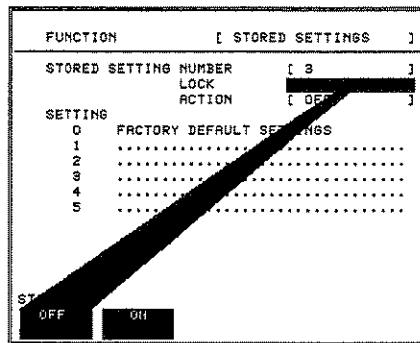

Highlight the SETTING description line N [.....].

Use JUMP PREVIOUS CHAR NEXT CHAR and ← and → to select characters.

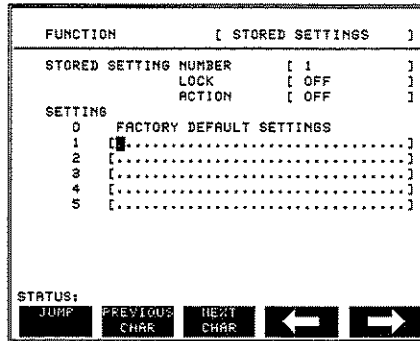

To prevent accidental overwriting of settings.

Highlight LOCK [3].

Select ON.

OFF must be selected to enable overwriting.

NOTE: Lock is forced ON after a RECALL or SAVE operation.

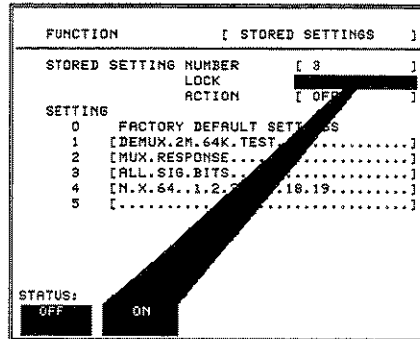

To Set the Date and Time

Press OTHER.

Select TIME & DATE.

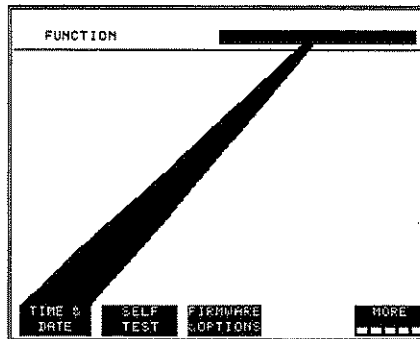

Highlight CLOCK MODE [1].

Select SET-UP.

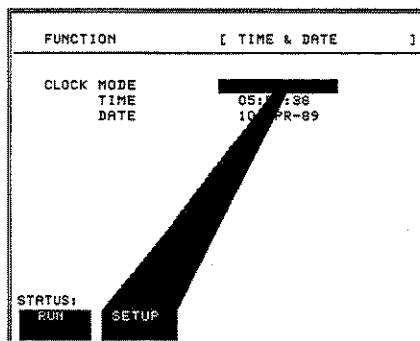

Highlight DATE [0-APR-89].

Use ← and →, INCREASE DIGIT / DECREASE DIGIT and PREVIOUS MONTH / NEXT MONTH to set the date.

FUNCTION	[TIME & DATE]
CLOCK MODE	[SETUP]
TIME	[5:58:34]
DATE	[0-APR-89]

STATUS:
DECREASE DIGIT INCREASE DIGIT ← →

Highlight TIME [5:58:34].

Use ← and →, and INCREASE DIGIT / DECREASE DIGIT, to set the time.

FUNCTION	[TIME & DATE]
CLOCK MODE	[SETUP]
TIME	[5:58:34]
DATE	[19-FEB-91]

STATUS:
DECREASE DIGIT INCREASE DIGIT ← →

To Start the Clock at the Selected Time

Highlight CLOCK MODE [SETUP].

Select RUN.

FUNCTION	[TIME & DATE]
CLOCK MODE	[RUN]
TIME	[11:00:00]
DATE	[19-FEB-91]

STATUS:
RUN SETUP

To Set BEEP on Errors

Press **OTHER**.

Select **MISCELLANEOUS**.

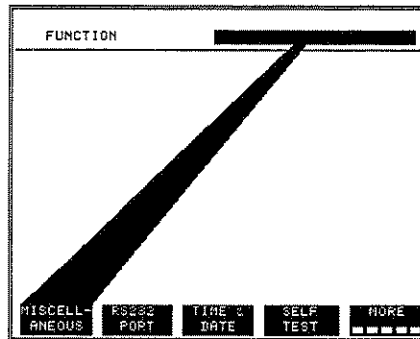

Highlight **BEEP ON ERROR** [**OFF**].

Select **OFF**, **ALL** or an error type.

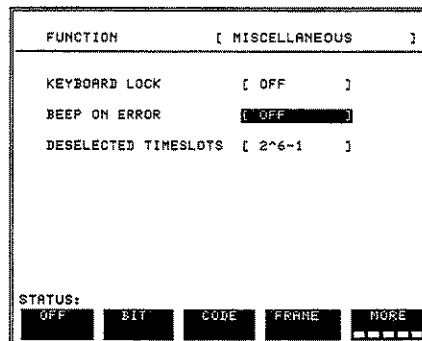

To Communicate Over the Line Under Test

This is an optional facility (Option 005/006) providing external drop and insert to and from 2Mbit/s or 704kbit/s.

Press **SETTINGS**.

Select **2Mb/s EXT D&I** or
704kb/s EXT D&I

```

APPLICATION
INTERFACE [ TERNARY ] LINECODE [ HDDB ]
FRAME (6.704) [ CAS MFM ]
THROUGH MODE [ OFF ]
TX CLOCK SOURCE [ INTERNAL ]

PATTERN [ 2^15-1 ]

RECEIVE TIMESLOT [ AS PER TX ]
Tx [ F*.....S..... ]
Bandwidth 64kb/s

ALARM GENERATION [ OFF ]
ERROR ADD [ BIT][SINGLE]

STATUS:
2Mb/s 2Mb/s 704kb/s 704kb/s MORE
FR SIN EXT D&I FR SIN EXT D&I
  
```

Highlight
INSERT TO TIMESLOT [].

Use **→**, **←**, **DECREASE DIGIT** and
INCREASE DIGIT to select the outgoing
timeslot .

```

APPLICATION [ 2Mb/s EXTERNAL D&I ]
INTERFACE [ TERNARY ] LINECODE [ HDDB ]
FRAME (6.704) [ CAS MFM ]
THROUGH MODE [ OFF ]
TX CLOCK SOURCE [ INTERNAL ]

EXTERNAL DROP & INSERT [ DATACOM ]
INSERT TO TIMESLOT [ 01 ] [ OFF ]
DROP FROM TIMESLOT [ 01 ]

SPEAKER / MICROPHONE [ OFF ]

STATUS:
DECREASE INCREASE
DIGIT DIGIT ← →
  
```

Highlight
INSERT TO TIMESLOT [01] []

Select **ON**

APPLICATION [2Mb/s EXTERNAL D&I]	
INTERFACE [TERNARY]	LINECODE [HDB3]
FRAME (G.704)	[CAS MFM]
THROUGH MODE [OFF]	
TX CLOCK SOURCE [INTERNAL]	
EXTERNAL DROP & INSERT [DATACOM]	
INSERT TO TIMESLOT [01]	[]
DROP FROM TIMESLOT [01]	
SPEAKER / MICROPHONE [OFF]	
STATUS:	
OFF	ON

Highlight
DROP FROM TIMESLOT []

Use **→**, **←**, **DECREASE DIGIT** and
INCREASE DIGIT to select the incoming
timeslot .

APPLICATION [2Mb/s EXTERNAL D&I]	
INTERFACE [TERNARY]	LINECODE [HDB3]
FRAME (G.704)	[CAS MFM]
THROUGH MODE [OFF]	
TX CLOCK SOURCE [INTERNAL]	
EXTERNAL DROP & INSERT [DATACOM]	
INSERT TO TIMESLOT [01] [ON]	
DROP FROM TIMESLOT []	[]
SPEAKER / MICROPHONE [OFF]	
STATUS:	
DECREASE DIGIT	INCREASE DIGIT ← →

Highlight
SPEAKER / MICROPHONE []



Select **ON**

APPLICATION [2Mb/s EXTERNAL D&I]	
INTERFACE [TERNARY]	LINECODE [HDB3]
FRAME (G.704)	[CAS MFM]
THROUGH MODE [OFF]	
TX CLOCK SOURCE [INTERNAL]	
EXTERNAL DROP & INSERT [DATACOM]	
INSERT TO TIMESLOT [01] [ON]	
DROP FROM TIMESLOT [01]	
SPEAKER / MICROPHONE []	
STATUS:	
OFF	ON

To use the speaker / microphone as a microphone, Press and hold

PUSH TO TALK.

Release **PUSH TO TALK** to listen to what is on the line.

Adjust the volume with  .

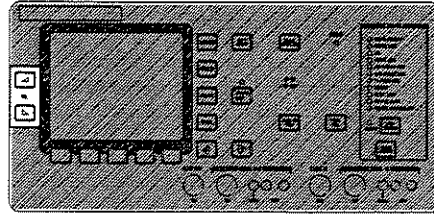

Setting the start time for a timed start measurement

Time start is available with Option 210 test sets.

To set the test set to start a test at a future time proceed as follows:

Press **RESULTS**

Highlight **TEST PERIOD** [].

Select **TIMED START**

Select the test period, start date and time that you want.

Setting for result printing at timed intervals

Printing at timed intervals is available with Option 210 test sets.

You may print results at regular timed intervals of 15 minutes, 1 hour or 24 hours. To set up for printing at timed intervals, proceed as follows:

Press **OTHER**.

Select **MISCELLANEOUS**.

Highlight **AUTO TRIGGERED PRINT** [].

Select the print interval you want.

Setting the Pattern Loss Threshold

To select the pattern loss threshold, proceed as follows:

Press **OTHER**

Select **ANALYSIS CONTROL**

Highlight **PATTERN LOSS []**.

Select **STANDARD** for pattern loss as specified in this manual or **0.151 (CCITT)**.

Setting BIS M.2100 Thresholds

For Bringing Into Service (BIS) M.2100 testing The pattern loss type and severely errored second thresholds are user selectable. To select these thresholds proceed as follows:

Press **OTHER**

Select **ANALYSIS CONTROL**

Highlight **ANALYSIS TYPE []**.

Select **M.2100**

Highlight **THRESHOLD TYPE []**.

Select the thresholds you want.

M.2120 TR2 Factor selection

M.2120 testing is available with option 210 test sets .

The TR2 limits used in a M.2120 test are the BIS objective multiplied by the TR2 factor. To select the TR2 factor proceed as follows:

Press **OTHER**

Select **ANALYSIS CONTROL**

Highlight **TR2 FACTOR []**.

Select the percentage you want.

Telecom Testing

This chapter gives you examples of telecom tests with typical displays. At the end of the chapter there is a full list of measurements and facilities available.

The parts of networks shown in the examples are taken from the following network illustration.

LTE = Line Terminal Equipment

MUX = Multiplexer/Demultiplexer

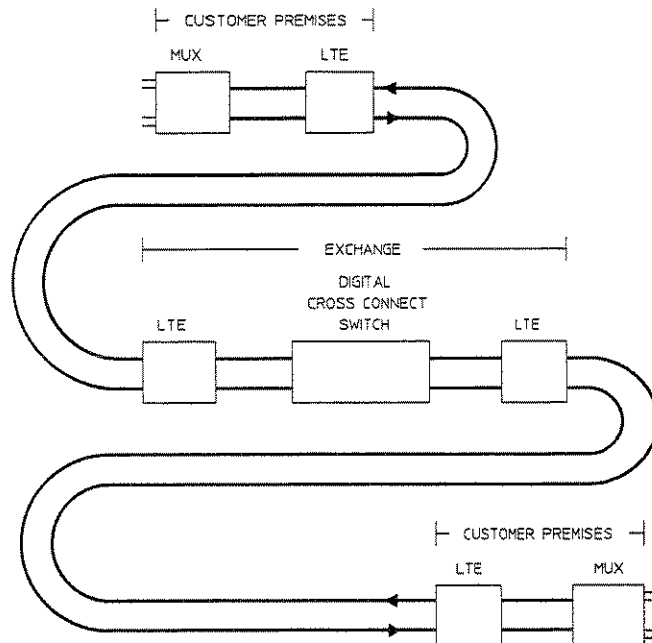

The test examples in this chapter are as follows :

Out Of Service Testing

- Network performance evaluation :
 - 2Mbit/s error performance (unframed LTE / LTE far end loopback test).
 - Wideband timeslot integrity (LTE / LTE end/end).
 - Tracing individual timeslots.
 - Investigating pattern dependent errors
 - Individual channel error performance (MUX / MUX far end loop back test).
- Mux Performance evaluation :
 - Mux / Demux function (2M/64k, 64K/2M).
 - Sync loss and regain thresholds (FAS error simulation).
 - Response to incoming alarms and alarm conditions (2Mb/s alarm generation, AIS). include remote alarm generation
 - X.50/X.58 Testing
 - A/D and D/A performance (TIMS ext drop and insert).
- Sync loss and response testing of LTEs or DCCs.
- Analog input variation tests.
- Analog measurements on digital channels.
- Real time data service evaluation.
 - Round trip delay test.

Bringing Into Service (BIS) M.2100 Testing

3-2 Telecom Testing

In Service Testing and Troubleshooting

- Monitoring error performance. Investigating infrequent alarm and error bursts (trouble scan) (high resolution graphics and zoom).
- Isolating the source of errors :
 - Finding an idle timeslot and looking for stuck signaling bits (CAS).
 - Isolating wideband, or single timeslot error sources.
 - Checking at monitor points down the line.
 - Troubleshooting CCS packet-type signaling protocols (protocol analyzer ext drop and insert).
- CRC4 network performance evaluation from one location.
 - Go and Return check from one end using E bits (Remote End Block Error) and CRC error check.
 - Monitoring VF traffic in channels (external drop to VF port).
- Monitoring ISDN error performance data in the NFAS word.

Out Of Service Testing

Network Performance Evaluation

To make a Typical Commissioning Test

This example shows a 2Mbit/s, Unframed, Far End Loopback, Test.

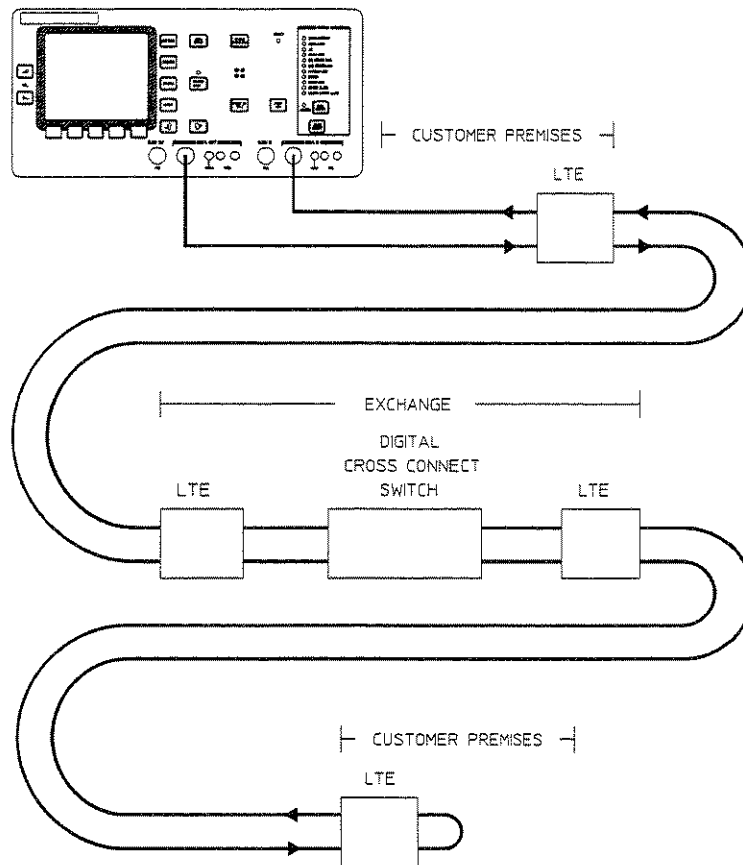

The same procedure may be used for a local loop test.

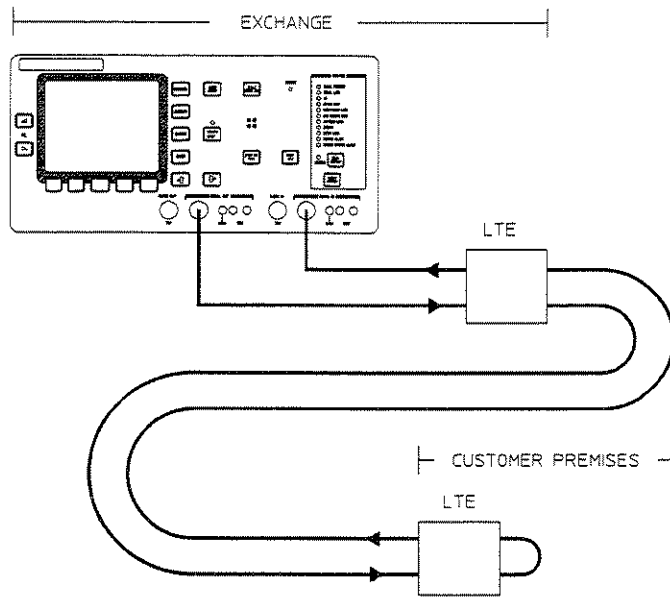

Press **SETTINGS**.

Set up the test conditions.

You may select **NORMAL** or **INVERTED** PRBS.

APPLICATION	[2Mb/s]			
INTERFACE [TERNARY]	LINECODE [HDB3]			
FRAME (6.704)	[OFF]			
TX CLOCK SOURCE	[INTERNAL]			
PATTERN	[2 ¹⁵ -1]			
ERROR ADD	[BIT] [SINGLE]			
STATUS:				
<input type="checkbox"/> OFF	<input type="checkbox"/> LOS NFM	<input type="checkbox"/> HO NFM	<input type="checkbox"/> CRS, ERG4 NFM	<input type="checkbox"/> ERG4 NFM

Check that the STATUS, SIGNAL PRESENT indicator is on.

STATUS	<input checked="" type="checkbox"/> SIGNAL PRESENT
	<input type="checkbox"/> LOS NFM
	<input type="checkbox"/> HO NFM
	<input type="checkbox"/> CRS, ERG4 NFM
	<input type="checkbox"/> ERG4 NFM
	<input type="checkbox"/> PATTERN LOSS
	<input type="checkbox"/> ERRORS

Press **RESULTS**.

Select the TEST PERIOD and STORAGE resolution.

Press **START/STOP**

Inverted PRBS is automatically recognized. The measurement continues normally. A status message tells you if inverted PRBS is being received.

RESULTS	(BER MEASUREMENTS)		
DISPLAY	[BASIC ERROR] [BIT]		
TEST PERIOD	[SINGLE] [15 MINS]		
STORAGE	[1 MIN] [15 MINS] [1 HOUR]		
ERRORS		
EFS		
CURRENT ER		
AVERAGE ER		
ELAPSED TIME	..d..h..m..s		
STATUS:			
<input type="checkbox"/> OFF	<input type="checkbox"/> 1 MIN RESOL 'N	<input type="checkbox"/> 15 MINS RESOL 'N	<input type="checkbox"/> 1 HOUR RESOL 'N

3-6 Telecom Testing

To Check Timeslot Integrity (including $n \times 64$) End/End

This example shows you how to find a wideband signal at the far end. A test pattern is transmitted over a group of timeslots from the near end. At the far end, the expected receive timeslots are selected and the SIGNAL PRESENT indicator shows if they contain the wideband signal. You can communicate over the test line using the optional external drop and insert. Use **SETTINGS** **MORE** and either **2Mb/s EXT D&I** or **704kb/s D&I**.

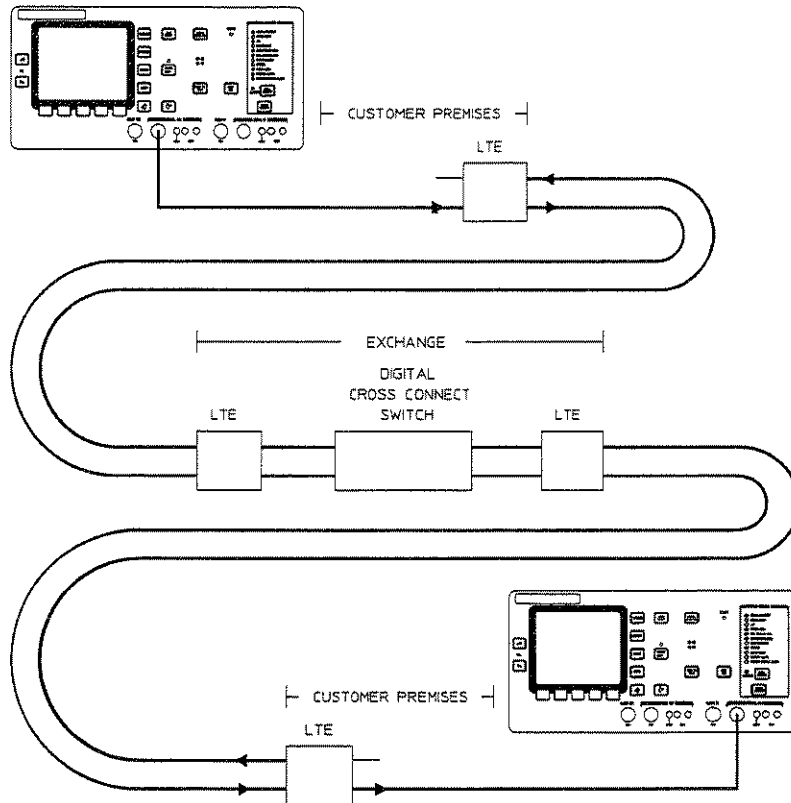

At the near end.

Press **SETTINGS**.

Set up the test conditions.

Select the timeslots that you want to spread the test pattern over, in this example, 1, 2 and 3.

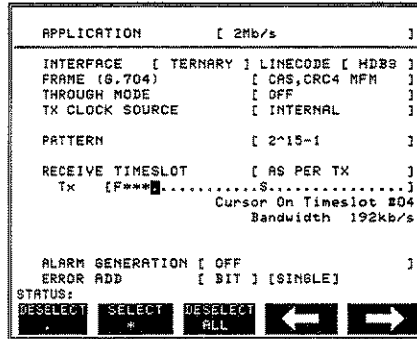

At the far end.

Press **SETTINGS**.

Select the expected receive timeslots.
These may be different from the near end Tx timeslots.

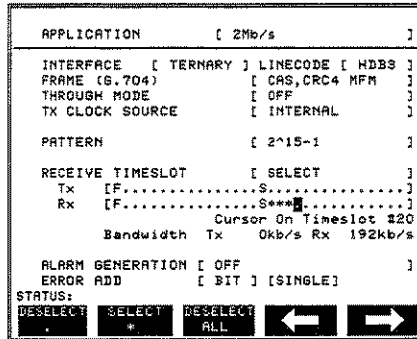

Check that the STATUS, SIGNAL PRESENT indicator is on. If it is not on, you can check individual timeslots as shown in the next example.

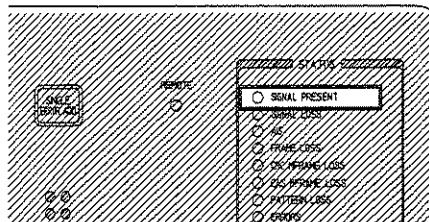

To Trace an Individual Timeslot

Individual timeslots may be quickly located by searching for a test pattern using TIMESLOT MONITOR.

At the near end.

Press **SETTINGS**.

Select an identifiable pattern and transmit in one of the timeslots.

```
APPLICATION      [ 2Mb/s      ]
INTERFACE [ TERNARY ] LINECODE [ HDB3 ]
FRAME (G.704)   [ CAS,CRC4 MPM ]
THROUGH MODE    [ OFF        ]
TX CLOCK SOURCE [ INTERNAL    ]

PATTERN          [ 16 BIT WORD ]
                [ 011101110110111 ]
RECEIVE TIMESLOT [ AS PER TX   ]
Tx [F*].....S.....
                Cursor On Timeslot #02
                Bandwidth 64kb/s

ALARM GENERATION [ OFF        ]
ERROR ADD        [ BIT ] [ SINGLE ]

STATUS:
DESELECT  SELECT  DESELECT  ← →
+         +         ALL
```

At the far end.

Press **RESULTS**.

Select **TIMESLOT MONITOR** and check the timeslots for the known pattern.

```
RESULTS [ TIMESLOT MONITOR ]
DISPLAY [ DATA ] [0]

01110111

SPEAKER [ OFF ]

STATUS:
DECREASE INCREASE ← →
DIGIT DIGIT
```

To Investigate Pattern Dependent Errors

You can set up a long user words, 4 words of up to 128 bytes each, and use them to test for errors occurring with particular patterns. In this example they are used in an $n \times 64$ circuit. To set or display the word content use **OTHER** **LONG USR WORD**. More details are given in chapter 2.

To use the long user word as your pattern

Press **SETTINGS**.

Highlight **PATTERN** [**2-1S-1**].

Select **LONG USR WORD**

```

APPLICATION [ 2Mb/s ]
INTERFACE [ TERNARY ] LINECODE [ HD32 ]
FRAME (6.704) [ CAS,CRC4 MFM ]
THROUGH MODE [ OFF ]
TX CLOCK SOURCE [ INTERNAL ]
PATTERN [ 2-1S-1 ]
RECEIVE TIMESLOTS [ AS PER TX ]
Tx [ F*.....S..... ]
Bandwidth 64kb/s
ALARM GENERATION [ OFF ]
ERROR ADD [ BIT ] [ SINGLE ]
STATUS:
1010 LONG USR 16 BIT LIVE MORE
WORD WORD DATA
  
```

Highlight **WORD NUMBER** [**1**].

Use **INCREASE DIGIT** and **DECREASE DIGIT** to select one of the 4 long user words.

```

APPLICATION [ 2Mb/s ]
INTERFACE [ TERNARY ] LINECODE [ HD32 ]
FRAME (6.704) [ CAS,CRC4 MFM ]
THROUGH MODE [ OFF ]
TX CLOCK SOURCE [ INTERNAL ]
PATTERN [ LONG USER WORD ]
WORD NUMBER [ 1 ] LENGTH 128
RECEIVE TIMESLOTS [ AS PER TX ]
Tx [ F*.....S..... ]
Bandwidth 64kb/s
ALARM GENERATION [ OFF ]
ERROR ADD [ BIT ] [ SINGLE ]
STATUS:
DECREASE INCREASE
DIGIT DIGIT
  
```

To Test Individual Channel Error Performance.

This example checks the complete customer go and return path at a 64 kbit/s co-directional interface.

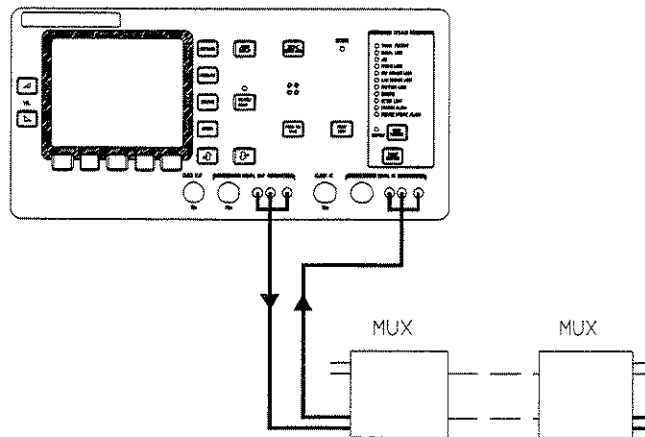

Press **SETTINGS**.

Set up the test conditions.

APPLICATION	[64kb/s]
INTERFACE	(CODIRECTIONAL)
TX CLOCK SOURCE	[INTERNAL]
CODIR OCTET TIMING	[ON]
PATTERN	[2 ¹⁵ -1]
ERROR ADD	(BIT) [SINGLE]
STATUS:	2 ²³ -1 2 ¹⁵ -1 2 ¹¹ -1 1111 NONE

Check the STATUS, SIGNAL PRESENT indicator

STATUS	RESOL	RESOL
<input type="checkbox"/> SIGNAL PRESENT	<input type="checkbox"/> SIGNAL LOSS	<input type="checkbox"/> SIGNAL LOSS
<input type="checkbox"/> TX FRAME LOSS	<input type="checkbox"/> TX FRAME LOSS	<input type="checkbox"/> TX FRAME LOSS
<input type="checkbox"/> RX FRAME LOSS	<input type="checkbox"/> RX FRAME LOSS	<input type="checkbox"/> RX FRAME LOSS
<input type="checkbox"/> PATTERN LOSS	<input type="checkbox"/> PATTERN LOSS	<input type="checkbox"/> PATTERN LOSS
<input type="checkbox"/> ERRORS	<input type="checkbox"/> ERRORS	<input type="checkbox"/> ERRORS

Press **RESULTS**.

Select the TEST PERIOD and STORAGE.

Press **START/STOP**

RESULTS	(BER MEASUREMENTS)
DISPLAY	[BASIC ERROR] [BIT]
TEST PERIOD	[SINGLE] [15 MINS]
STORAGE	[]
ERRORS
EFS
CURRENT ER
AVERAGE ER
ELAPSED TIME	..d ..h ..m ..s
STATUS:	OFF 1 MIN RESOL 'N 15 MINS RESOL 'N 1 HOUR RESOL 'N

Mux Performance evaluation

To Test the Mux / Demux Function

This example procedure is for multiplexing. The 64 kbit/s co-directional test pattern is used for the multiplexer input. The test timeslot is demultiplexed from the 2 Mb/s multiplexer output.

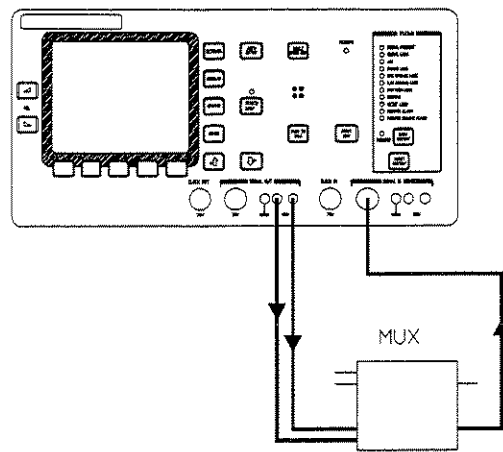

Press **SETTINGS**.

Select **64kb/s Tx 2Mb/s Rx**.

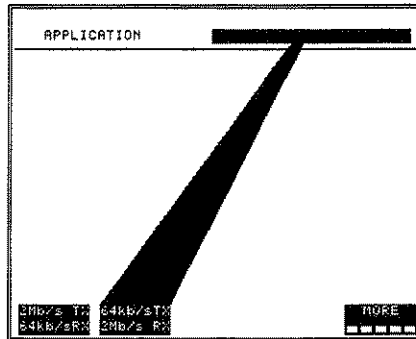

Set up the test conditions.

Highlight **FROM TIMESLOT** [**0**].

Select the timeslot you want to check.

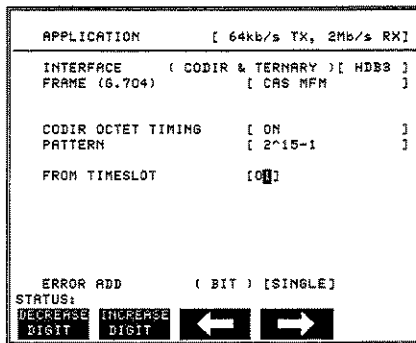

Check that the **STATUS, SIGNAL PRESENT** indicator is on.

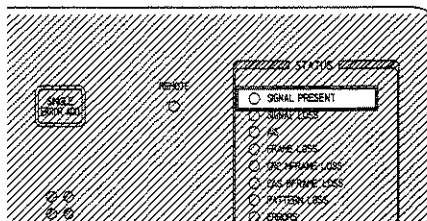

To Check Sync Loss and Regain Thresholds.

Sync thresholds may be checked by introducing errors into the framing words using the "Frame Simulation" application.

The background (deselected) timeslots should be set to 2^6-1 , as described in chapter 2, to correctly exercise the multiplexer sync criteria.

Alignment signal	Multiplexer reaction	Errored words
FAS	Sync	2 in 4
	Maintain sync	1 in 2
	Sync loss	3 in 4
	Maintain sync loss	1 in 2
	Sync gain	2 in 4
FAS ERROR RATES of 2E-3,5E-4,2E-5 and 5E-6 are available.		
NFAS	Sync gain	1 in 2
	Sync loss	3 in 4
CAS MFAS	Multiframe sync gain	1 in 2
	Multiframe sync loss	All errored
CRC MFAS	Sync	2 in 4
	Maintain sync	3 in 4
	Sync loss	LOSE FM SYNC
	Maintain sync loss	3 in 4
CRC BITS	Sync gain	2 in 4
	Sync gain	Rate $n \leq 914$ errors
	Sync loss	$n > 914$ errors

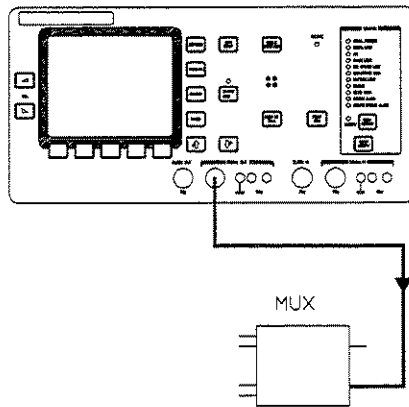

Press **SETTINGS**.

Select **2Mb/s FM SIM**.

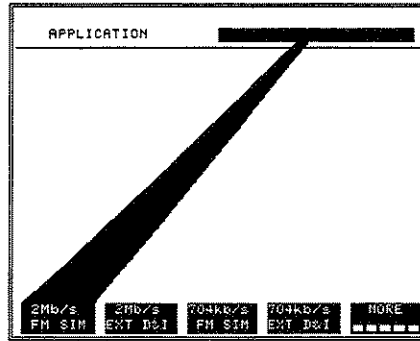

Set up the test conditions.

Highlight **TEST**.

Select the alignment signal you want to check.

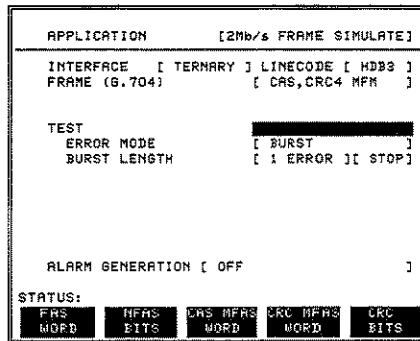

Select the **ERROR MODE** and **ERROR RATE** for the threshold you want to check.

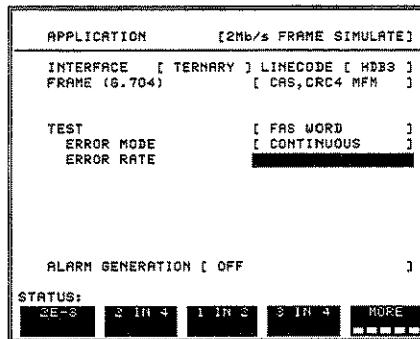

To Test Multiplexer Response to Incoming Alarms and Alarm Conditions

Example 1

You may check alarm indicators on the multiplexer and the ability of the multiplexer to generate a “remote” alarm signal. This example, which shows an AIS alarm threshold test, may also be used for multiplexer response to the no signal condition and the incoming alarms: remote alarm and remote multiframe alarm.

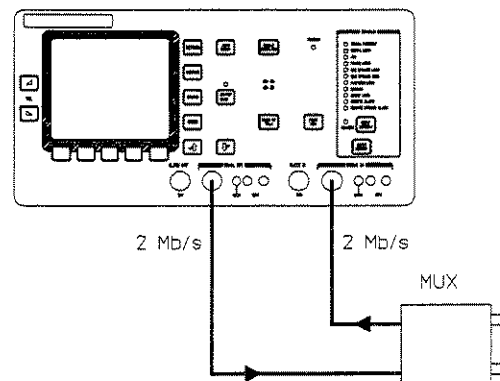

Press **SETTINGS**.

Select **2Mb/s**.

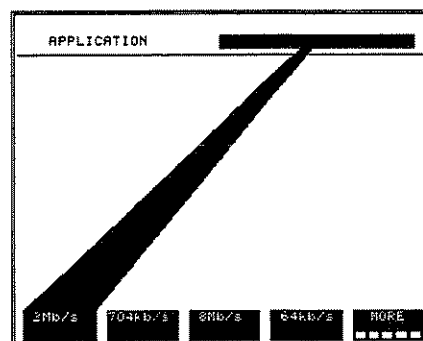

Set up the test conditions.

Highlight ALARM GENERATION

[...].

Select the alarm or alarm condition you want to simulate and check the response of the demultiplexer. For example check that the AIS alarm is on with AIS 2 (zeros) IN 512 and off with AIS 3 (zeros) IN 512.

APPLICATION	[2Mb/s]		
INTERFACE	[TERNARY]	LINECODE	[HDB3]
FRAME (G.704)	[CAS MFM]		
THROUGH MODE	[OFF]		
TX CLOCK SOURCE	[INTERNAL]		
PATTERN	[2~15-1]		
RECEIVE TIMESLOT	[AS PER TX]		
Tx	[F*.....S.....]		
		Bandwidth	64kb/s
ALARM GENERATION	[...]		
ERROR ADD	[BIT]	[SINGLE]	
STATUS:			
OFF	AIS	AIS	AIS
	ALL CHES	2 IN 512	8 IN 512
			MORE

You may check the generation of remote alarm with the STATUS indicators.

STATUS [...]	
<input type="radio"/>	SIGNAL PRESENT
<input type="radio"/>	SIGNAL LOSS
<input type="radio"/>	AIS
<input type="radio"/>	FRAME LOSS
<input type="radio"/>	FRC MFRAME LOSS
<input type="radio"/>	CAS MFRAME LOSS
<input type="radio"/>	PATTERN LOSS
<input type="radio"/>	ERRORS
<input type="radio"/>	OCTET LOSS
<input type="radio"/>	REMOTE ALARM
<input type="radio"/>	REMOTE MFRAME ALARM

Example 2

For Multiplexers which generate remote and block errors you may check that the Remote End Block Error signal is produced when the input CRC bits are errored. When a CRC check detects errors, the E bits (REBE bits) are changed from 1 to 0. The REBE return path test counts the E bits.

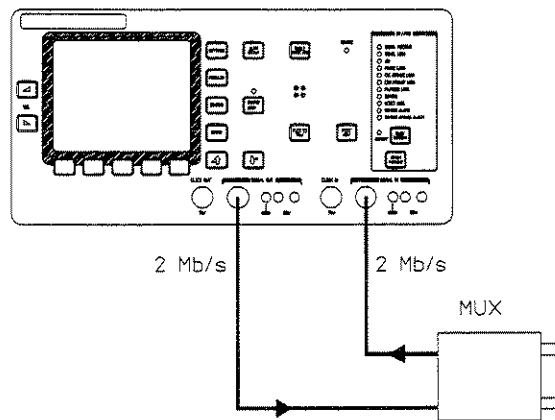

Press **SETTINGS**.

Select **2Mb/s FM SIM**.

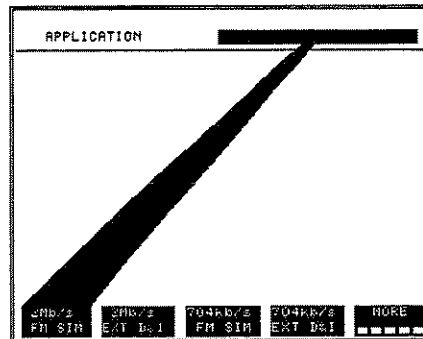

Set up the test conditions.

Highlight TEST [**TEST**].

Select CRC BITS

```
APPLICATION [2Mb/s FRAME SIMULATE]
INTERFACE [ TERNARY ] LINECODE [ HD33 ]
FRAME (G.704) [ CAS,CRC4 MFM ]

TEST
ERROR MODE [ BURST ]
BURST LENGTH [ 1 ERROR ]

ALARM GENERATION [ OFF ]

STATUS:
FAS MFM CAS MFM CRC MFM
WORD BITS WORD WORD BITS
```

Select the ERROR MODE and ERROR RATE for the test.

```
APPLICATION [2Mb/s FRAME SIMULATE]
INTERFACE [ TERNARY ] LINECODE [ HD33 ]
FRAME (G.704) [ CAS,CRC4 MFM ]

TEST
ERROR MODE [ CRC BITS ]
ERROR RATE [ CONTINUOUS ]
[ N IN 1000 ]
N = [0000]

ALARM GENERATION [ OFF ]

STATUS:
DECREASE INCREASE
DIGIT DIGIT ← →
```

Press **RESULTS**.

Select **BER MEASUREMENTS**,
BASIC ERROR, **REBE**.

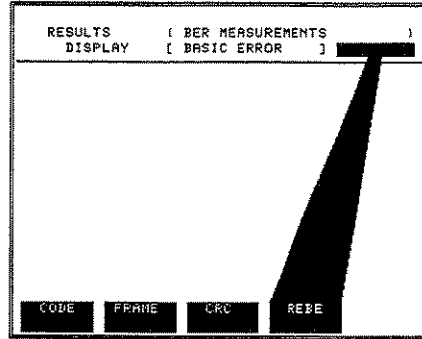

Press **START / STOP**.

Check that Remote End Block Errors are
being generated.

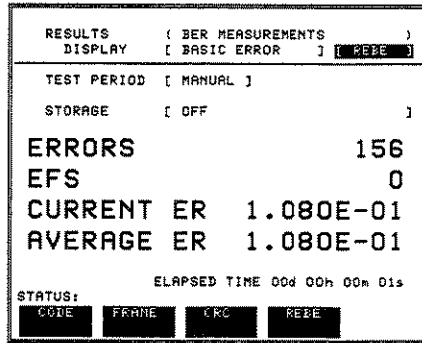

To Test Network Equipment Synchronization Criteria

You may generate errors in the 2 Mbit/s frame and multi-frame words to check network equipment synchronization criteria. The sync loss and regain thresholds are given in the previous Mux and Demux testing examples. The following example shows a CRC multi-frame test of a Line Terminal Equipment (LTE) or Digital Cross Connect (DCC), similar tests may be used for frame sync and for CAS multi-frame.

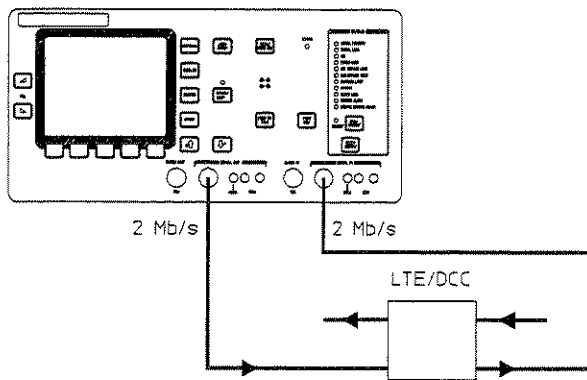
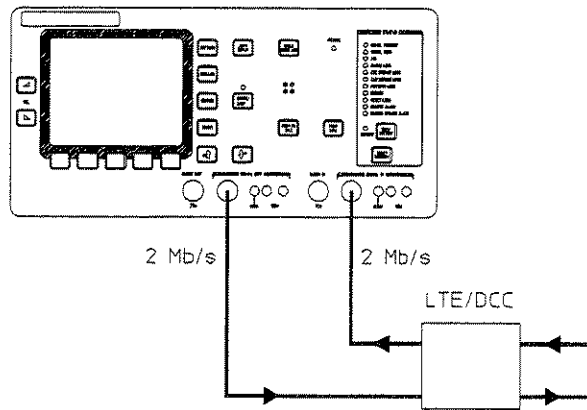

Press **SETTINGS**.

Select **2Mb/s FM SIM**.

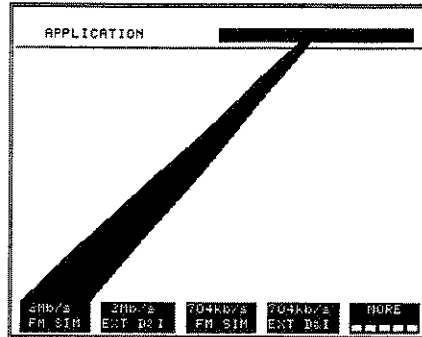

Set up the test conditions.

Highlight **TEST** [**TEST**].

Select the alignment signal you want to check. In this example the CRC multi-frame alignment signal word.

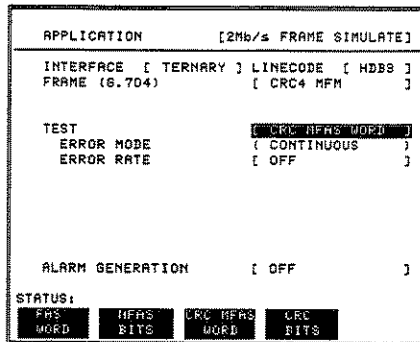

Select the **ERROR MODE** and **ERROR RATE** for the threshold you want to check.

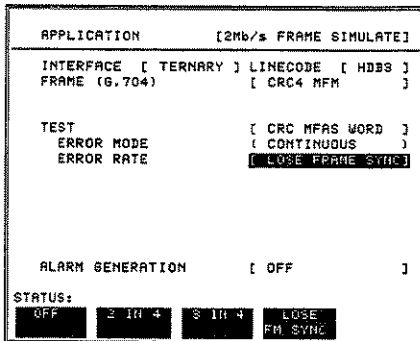

Check that the LTE / DCC correctly generates AIS and REMOTE ALARM

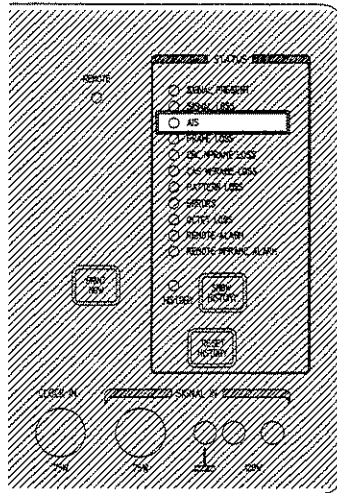
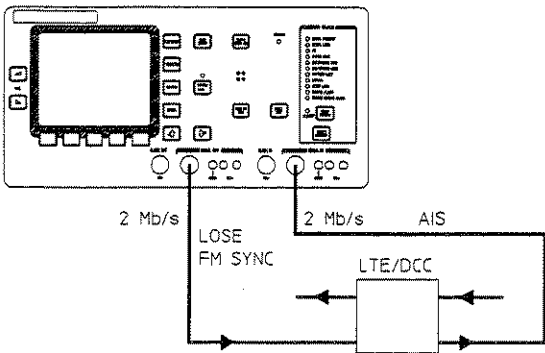
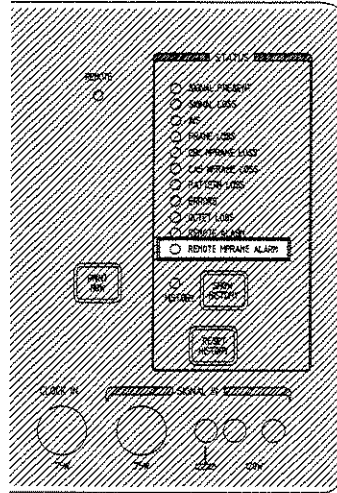
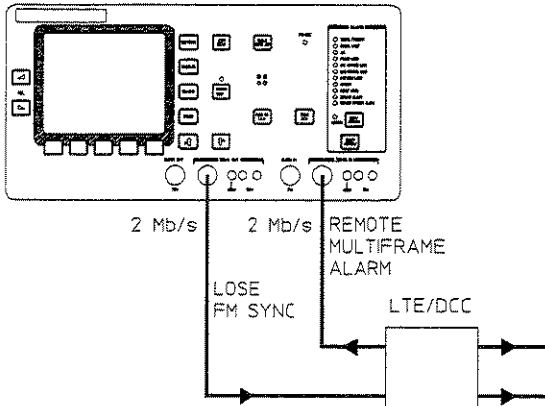

To Check an X.50/X.58 Channel on Both Sides of a Multiplexer

An X.50 or X.58 sub rate test pattern may be generated in a 64kbit/s or 2Mbit/s signal and errors measured at 64kbit/s or 2Mbit/s test points. The following example shows a demux test using two instruments. The X.50 sub rate test pattern is generated in a 2 Mbit/s signal and the error measurements made on the demultiplexed output.

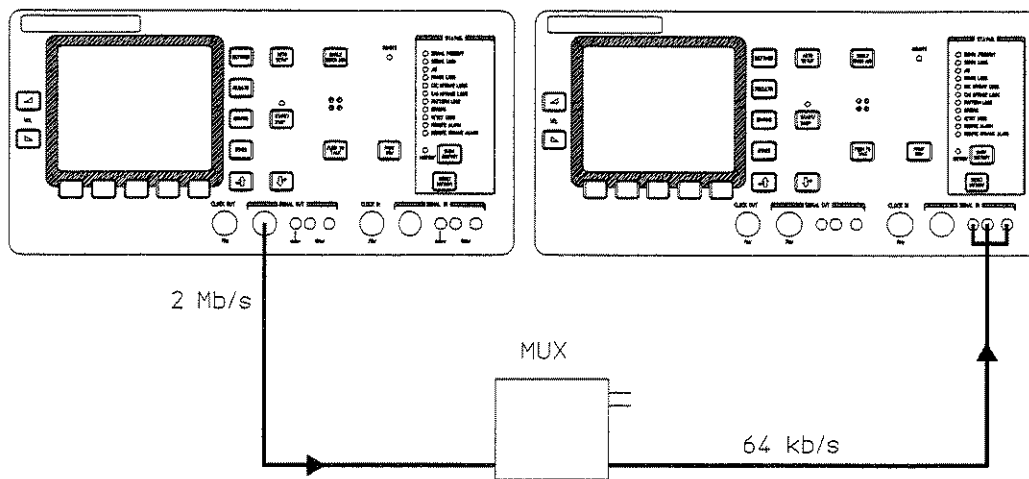

To Generate the Test Pattern

Set up the transmitting instrument.

Press **SETTINGS**.

Select **SUB RATE**.

Highlight **SUB RATE STRUCTURE** [] and select the structure you want. This example uses X.50 div 2.

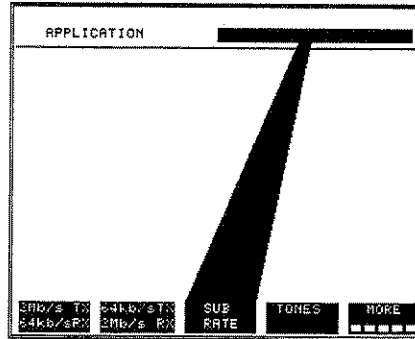

Highlight **BEARER RATE** [] and select **64kb/s** or **2Mb/s**. This example uses 2 Mbit/s.

Highlight **DISPLAY** []

Select **BEARER SET-UP**.

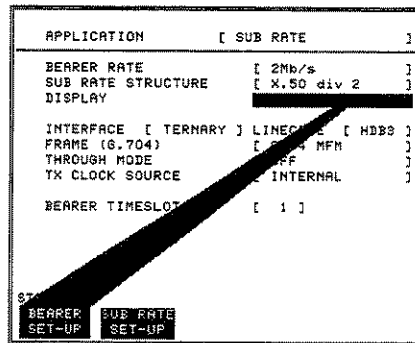

Set the bearer parameters.

Select the **BEARER TIMESLOT**.

You now need to set the sub-rate parameters.

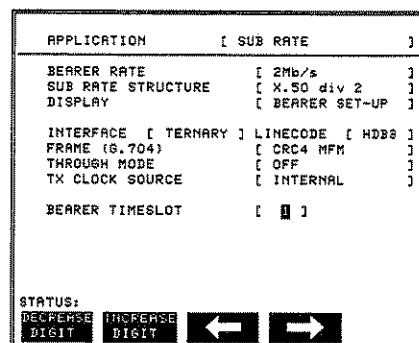

Highlight DISPLAY [].

Select SUB RATE SET-UP

APPLICATION	[SUB RATE]
BEARER RATE	[2Mb/s]
SUB RATE STRUCTURE	[X.50 div 2]
DISPLAY	[SUB RATE SET-UP]
INTERFACE [TERNARY]	LINECODE [HD30]
FRAME (S,704)	[CRAMFM]
THROUGH MODE	[]
TX CLOCK SOURCE	[INTERNAL]
BEARER TIMESLOT	[1]
STATUS:	
BEARER SET-UP	SUB RATE SET-UP

Set the sub rate parameters

Highlight PATTERN [].

Select the pattern you want to send in the customer circuit (sub rate).

APPLICATION	[SUB RATE]
BEARER RATE	[2Mb/s]
SUB RATE STRUCTURE	[X.50 div 2]
DISPLAY	[SUB RATE SET-UP]
PATTERN	[16 BIT WORD]
	[F1001010F1110000]
CHANNEL AND RATE	[140] 2.4kb/s
MAPPING	1 - ...*.....
	21 - ...*.....
	41 - ...*.....
	61 - ...*.....
DESELECTED OCTETS	[F0000000]
ERROR ADD [BIT]	[SINGLE]
STATUS:	
DECREASE DIGIT	INCREASE DIGIT

Highlight CHANNEL AND RATE [].

Select the SUB RATE CHANNEL.

You can select your own sub rate mapping see chapter 2.

You can also select X.50 div 2 FAS bits, X.50 div 3 FAS bit A, and X.58 service octet content, see chapter 2.

To Measure Errors at 64kbit/s or 2Mbit/s Monitor Points

Set up the receiving instrument.

Press **SETTINGS**.

Select **SUB RATE**.

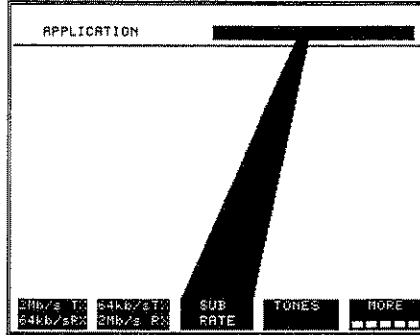

Highlight **BEARER RATE** [3].

Select the rate at the monitor point.

You need to set both the bearer and the sub-rate parameters as you did for the transmitting instrument.

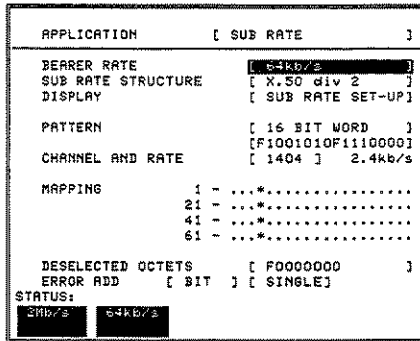

Press **RESULTS**.

Select **BER MEASURE**.

If you want to store the results or display them as graphs, set a **STORAGE** resolution.

Set the **TEST PERIOD** you want and press **START/STOP**.

RESULTS	[BER MEASUREMENTS]
DISPLAY	[BASIC ERROR] [BIT]
TEST PERIOD	[SINGLE] [USER PROGRAM]
	[2] [HOURS]
STORAGE	[OFF]
ERRORS	3
EFS	200
CURRENT ER	0
AVERAGE ER	6.188E-06
ELAPSED TIME 00d 00h 03m 22s	
STATUS:	
BASIC ERROR	6.821 ANALYSIS
ALARM SECONDS	TROUBLE SCAN

Highlight **DISPLAY [6.821]**.

All errors are measured.
Select what you want to display.

RESULTS	[BER MEASUREMENTS]
DISPLAY	[6.821 ANALYSIS] [BIT]
TEST PERIOD	[SINGLE] [USER PROGRAM]
	[2] [HOURS]
STORAGE	[OFF]
6.821 fixed thresholds used	
UNAVAILABILITY	0 0.00000%
ERRORED SECONDS	8 1.47783%
SEVERELY ERRORED SECS	0 0.00000%
DEGRADED MINUTES	1 25.00000%
LTMR	6.158E-06
ELAPSED TIME 00d 00h 03m 23s	
STATUS:	
BASIC ERROR	6.821 ANALYSIS
ALARM SECONDS	TROUBLE SCAN

To Test Speech Quality (A/D, D/A Performance)

The A/D and D/A performance is checked by using a TIMS on the 64 kbit/s side and the telecom analyzer as a drop and insert interface on the 2 Mbit/s side.

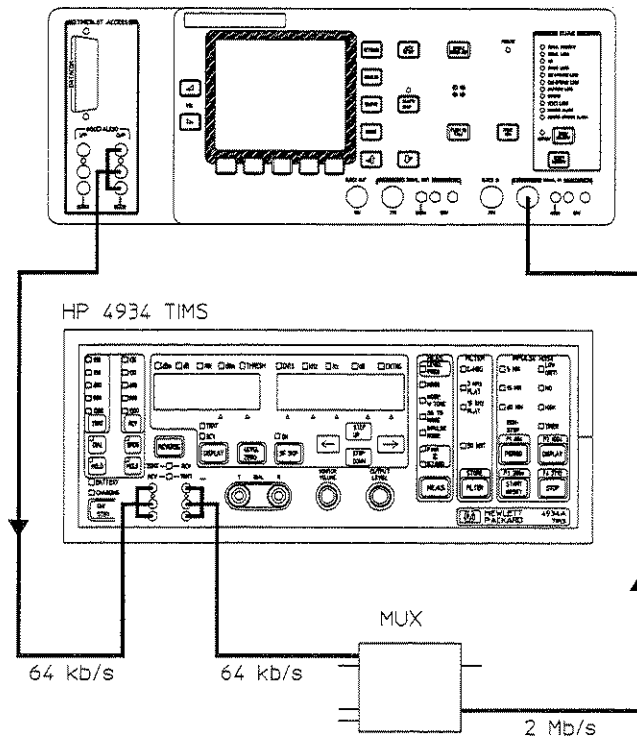

Example A/D Test

Press **SETTINGS**.

Select **2Mb/s EXT D & I**.

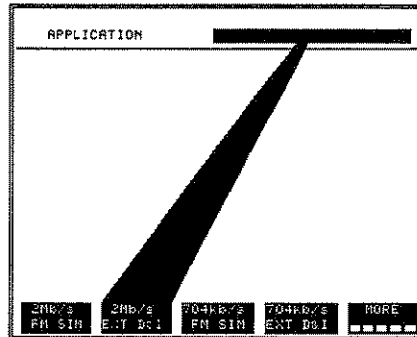

Set up the test conditions.

Highlight **EXTERNAL DROP & INSERT** []

Select **6000 AUDIO**.

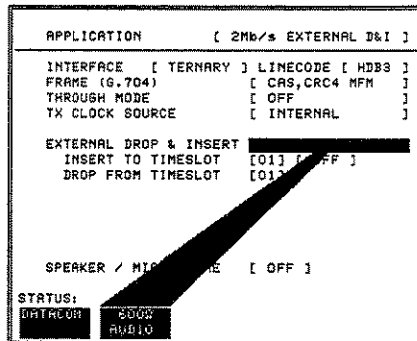

Highlight **DROP FROM TIMESLOT** []

Select the timeslot being tested.

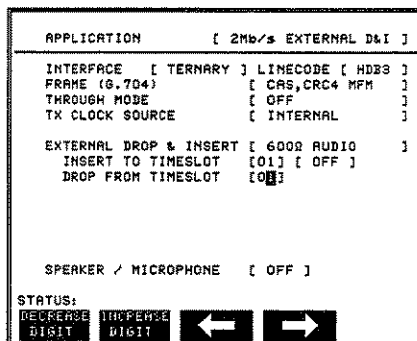

To Test Timeslot Switching Capability with Input Level Variation

You may generate a tone with selectable level and frequency for insertion into one or more timeslots. You may measure the level and frequency of the received tone in any one timeslot. Quick checks of line cards can be made using the coder offset and peak codes measurement. The following example shows a level test for a link sharing, voice actuated switching system.

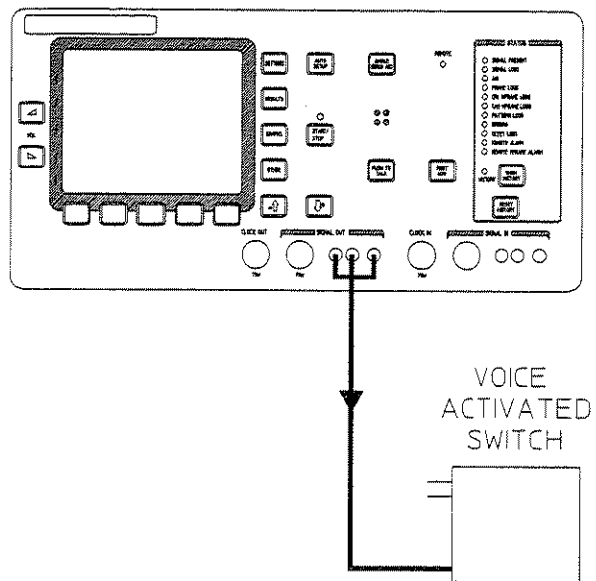

Press **SETTINGS**.

Select **TONES**

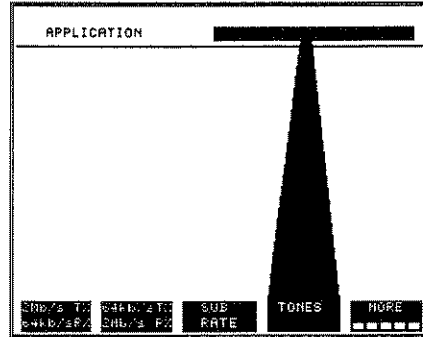

Set the interface for the system being tested.

Highlight Tx [**1**].

Select the test timeslot

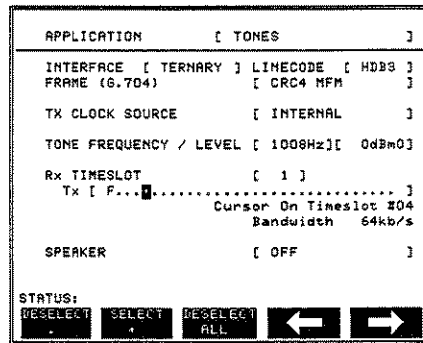

Highlight **1008Hz** / LEVEL [**0dBm0**].

Select the test tone

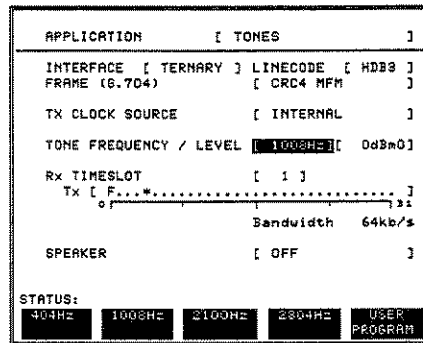

Highlight
 TONE FREQUENCY / LEVEL [1008Hz]
 [].

Use DECREASE DIGIT AND
 INCREASE DIGIT to vary the level
 through the switching points.

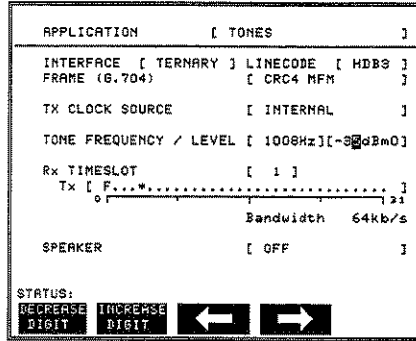

To Make Analog Measurements on Digital Channels.

You may generate a tone and insert it into any number of 64 kbit/s timeslots in a 2 Mbit/s stream. You may measure the received level, frequency and code offset in a selected timeslot. The following example shows a demux/mux loopback test.

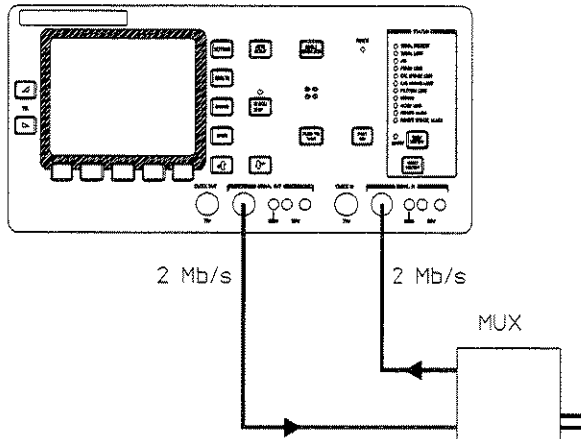

Set the level and frequency of the tone and select the timeslots as for the previous example "To Test Timeslot Switching Capability with Input Level Variation".

Press **RESULTS**.

Select **SIGNAL**.

RESULTS (BER MEASUREMENTS)	
DISPLAY	
TEST PERIOD	[MANUAL]
STORAGE	[OFF]
TONE FREQUENCY	1008 Hz
TONE LEVEL	-15.0 dBm
CODER OFFSET	0
MAX POSITIVE	+79
MAX NEGATIVE	-79
ELAPSED TIME	00m 00s
STATUS:	
BASIC	0.021
ERROR	ANALYSIS
ALARM	SECONDS
SIGNAL	TROUBLE
	SCAN

Real time data service Installation

Services to be used for real time data and in particular for LAN interconnection may have a maximum round trip delay specification. If excessive delays occur due to the number of devices (for example digital cross connect switches) used, the circuit may need to be re-configured.

To Measure Round trip Delay.

Sources of delay may be identified by looping back at different points in the network.

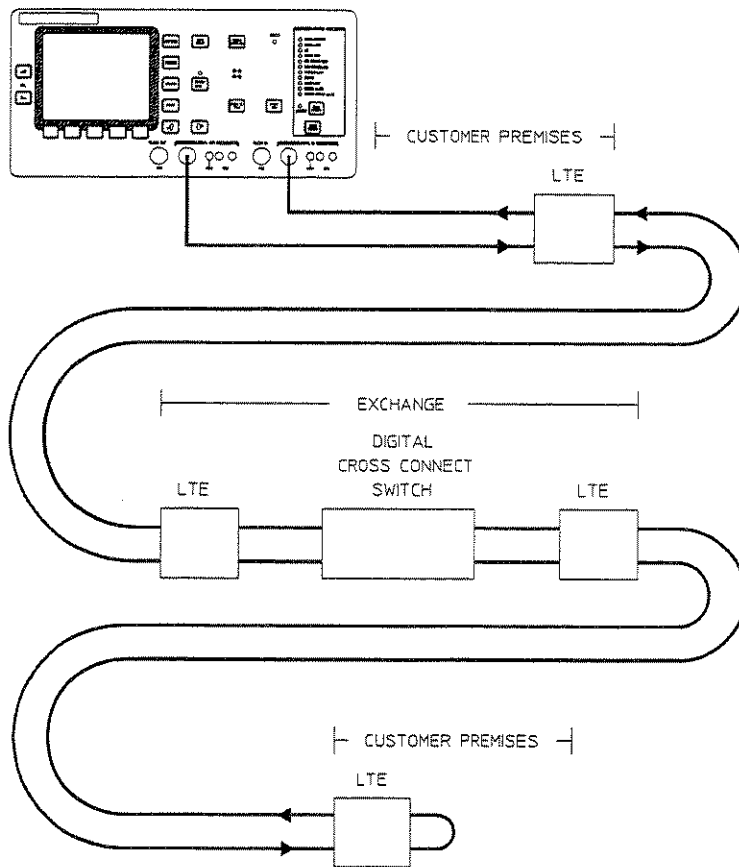

Press **SETTINGS**.

Select **2Mb/s**.

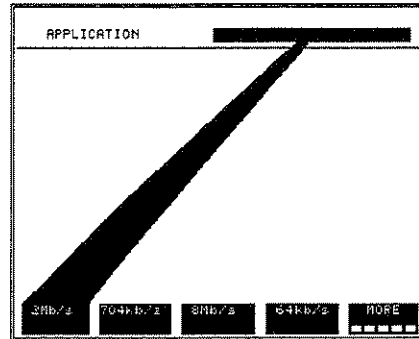

Set up the test conditions.

Highlight **PATTERN** [**2²³-1**].

Select **2²³-1**.

Transmit the pattern over all timeslots to reduce the test time.

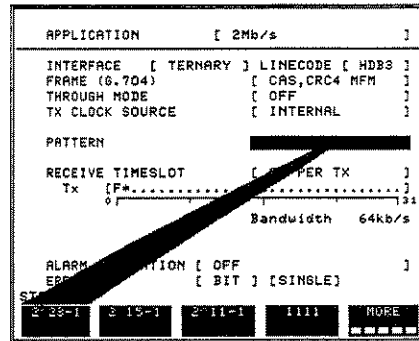

Press **RESULTS**.

Select **BER MEASUREMENTS**, **SIGNAL**. The resolution of the round trip delay result is automatically selected.

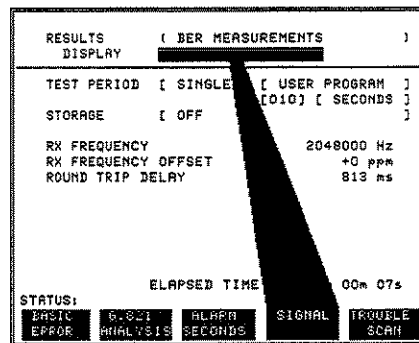

To Loopback Using NFAS Codes

The spare national (Sa) bits in the CRC4 NFAS word (bits 4 to 8 of timeslot 0 in each of the odd numbered frames) may be used for various purposes. An 8 bit word, one of the bit positions in each of the 8 odd numbered frames, may be used to set up loopbacks.

You may select an 8 bit code in one bit position of the NFAS word.

You may also select 5 bits to be bits 4 to 8 in every NFAS word. This selection is only necessary if your system uses more than one of the spare bits or if you want to change the alternative to the 8 bit code between all 1's and all 0's.

You may switch between the selected code word and a selected fixed bit in the chosen bit position (4 to 8) by selecting SEND or HOLD on the display.

Press **OTHER**.

Select **2Mb/s T/S-0&16**

FUNCTION		[2Mb/s T/S-0&16 BITS]	
S1 BITS			
NON-CRC4 FRAME	[1]		
CRC4 FRAME E-BITS (FRM 13,15)	[11]		
Sa BITS			
NFAS FRAME T/S-0 BITS 4-8	[11111]		
CRC4 FRAME CODEWORD..	[11111111]		
..INTO NFAS FRAME BIT	[4]	[HOLD]	
CAS MFM BITS			
T/S-16 FRAME-0 BITS 5,7,8	[111]		
ABCD BITS	[0101]		
STATUS:			
STORED	2Mb/s	704kb/s	SUB RATE
SETTINGS	T/S-0&16	T/S-0	BITS

Highlight **Sa BITS NFAS FRAME T/S-0 BITS 4-8** [**1010**].

Use **→**, **←**, **SET 0** and **SET 1** to set the normal NFAS word you want. In this example bits 4 to 8 are set to 10101.

FUNCTION		[2Mb/s T/S-0&16 BITS]
Si BITS		
NON-CRC4 FRAME	[1]	
CRC4 FRAME E-BITS (FRM 13,15)	[11]	
Sa BITS		
NFAS FRAME T/S-0 BITS 4-8	[1010]	
CRC4 FRAME CODEWORD..	[11111111]	
..INTO NFAS FRAME BIT	[4] (HOLD)	
CAS MFH BITS		
T/S-16 FRAME-0 BITS 5,7,8	[111]	
ABCD BITS	[1010]	
STATUS:		
SET 0	SET 1	← →

You will now have this word as bits 4 to 8 of your odd numbered frames. The 8 bit code in bit 4 will be all 1's. This is what will be transmitted while [HOLD] is displayed.

FRAME	BITS				
	4	5	6	7	8
1	1	0	1	0	1
3	1	0	1	0	1
5	1	0	1	0	1
7	1	0	1	0	1
9	1	0	1	0	1
11	1	0	1	0	1
13	1	0	1	0	1
15	1	0	1	0	1

Highlight **.. INTO NFAS FRAME BIT** [**4**].

Select the bit you want to send your loopcode in. In this example, bit 4.

FUNCTION		[2Mb/s T/S-0&16 BITS]
Si BITS		
NON-CRC4 FRAME	[1]	
CRC4 FRAME E-BITS (FRM 13,15)	[11]	
Sa BITS		
NFAS FRAME T/S-0 BITS 4-8	[10101]	
CRC4 FRAME CODEWORD..	[11111111]	
..INTO NFAS FRAME BIT	[4] (HOLD)	
CAS MFH BITS		
T/S-16 FRAME-0 BITS 5,7,8	[111]	
ABCD BITS	[1010]	
STATUS:		
DECREASE BIT	INCREASE BIT	

Highlight CRC4 FRAME CODEWORD

[1].

Select the loopcode you want to send in the selected bit. In this example 11011110.

```

FUNCTION [ 2Mb/s T/S-0&16 BITS]
-----
Si BITS
NON-CRC4 FRAME [ 1 ]
CRC4 FRAME E-BITS (FRM 13,15) [ 11 ]

Sa BITS
NFAS FRAME T/S-0 BITS 4-8 [ 10101 ]
CRC4 FRAME CODEWORD.. [ 11011110 ]
..INTO NFAS FRAME BIT [4] [ HOLD ]

CAS MFH BITS
T/S-16 FRAME-0 BITS 5,7,8 [ 111 ]
ABCD BITS [ 1010 ]

STATUS:
SET 0 SET 1 [←] [→]
    
```

Highlight . . INTO NFAS FRAME BIT

[4] [SEND].

Select **SEND** to send the loopcode in the selected bits.

```

FUNCTION [ 2Mb/s T/S-0&16 BITS]
-----
Si BITS
NON-CRC4 FRAME [ 1 ]
CRC4 FRAME E-BITS (FRM 13,15) [ 11 ]

Sa BITS
NFAS FRAME T/S-0 BITS 4-8 [ 10101 ]
CRC4 FRAME CODEWORD.. [ 11011110 ]
..INTO NFAS FRAME BIT (4) [ SEND ]

CAS MFH BITS
T/S-16 FRAME-0 BITS 5,7,8 [ 111 ]
ABCD BITS [ 1010 ]

STATUS:
SEND HOLD
    
```

You will now have this word as bit 4 of your odd numbered frames. This is what will be transmitted while [SEND] is displayed.

FRAME	BITS				
	4	5	6	7	8
1	1	0	1	0	1
3	1	0	1	0	1
5	0	0	1	0	1
7	1	0	1	0	1
9	1	0	1	0	1
11	1	0	1	0	1
13	1	0	1	0	1
15	0	0	1	0	1

Bringing Into Service (BIS) M.2100 Testing

The test set has provision for making M.2100 tests and with option 210, for making M.2110 and M.2120 tests.

M.2100 Testing

For M.2100 in-service monitoring (FAS based), counts of errored seconds (ES), severely errored seconds (SES) and availability are provided for both the Rx and Tx directions.

For M.2100 out-of-service (bring into service, BIS) monitoring (FAS and payload based), counts of errored seconds (ES), severely errored seconds (SES) and availability are provided for the Rx direction.

More detailed information is provided in the specifications in this manual.

To run a test proceed as follows:

Check that the thresholds are set as required for the test.

Use **OTHER**, **ANALYSIS CONTROL**, **ANALYSIS TYPE M.2100** to display the current selection and select new values if required.

Press **RESULTS**.

Select **BER MEASUREMENTS**.

Highlight **DISPLAY []**.

Select **M.21XX ANALYSIS**.

Highlight **TEST PERIOD []** and select the test period you want.

M.2110 and M.2120 Testing

Option 210 of the test set provides the capability of M.2110 (in-service monitoring) and M.2120 (Bring into Service testing).

To run a test proceed as follows:

Check that the thresholds and, for M.2120, the TR2 factor are set as required for the test.

Thresholds and the M.2120 TR2 factor (which modifies the TR2 limits) are selectable. For M.2120 the TR2 limits are the BIS objective multiplied

by the TR2 factor. Use **OTHER**, **ANALYSIS CONTROL**, **ANALYSIS TYPE**
M.2100 to display the current threshold and TR2 factor selections.

Select new values if required.

Press **RESULTS**.

Select **BER MEASUREMENTS**.

Highlight **DISPLAY** [].

Select **M.21XX ANALYSIS**.

Highlight **DISPLAY [M.21XX ANALYSIS]** [].

Select **M.2110 ANALYSIS** or **M.2120 ANALYSIS**.

Highlight **PATH ALLOCATION** [] and set the path allocation for the path being tested. The setting of Path Allocation Percentages is used to derive the S1 and S2 limits used in M.2120 tests and the TR1 and TR2 limits used in M.2110 tests.

Highlight **TEST PERIOD** [] and select the test period you want.

During M.2120 tests, **WAIT** is displayed until the test has been completed. On completion either **PASS** or **FAIL** is displayed.

In Service Testing and Troubleshooting

To Monitor error performance.

When an error measurement is made, all error types are recorded. You chose how you want to display them during and after the test. If you want to display the result as a graph you need to select a storage resolution before you start the test. The selection of storage may cause previously stored results to be lost, see “To Set Up For Storage of Results” in chapter 2 and “General Specifications” “Storage” in chapter 6.

To Investigate infrequent alarm and error bursts

This example shows two of the most useful ways of displaying the results of this type of test.

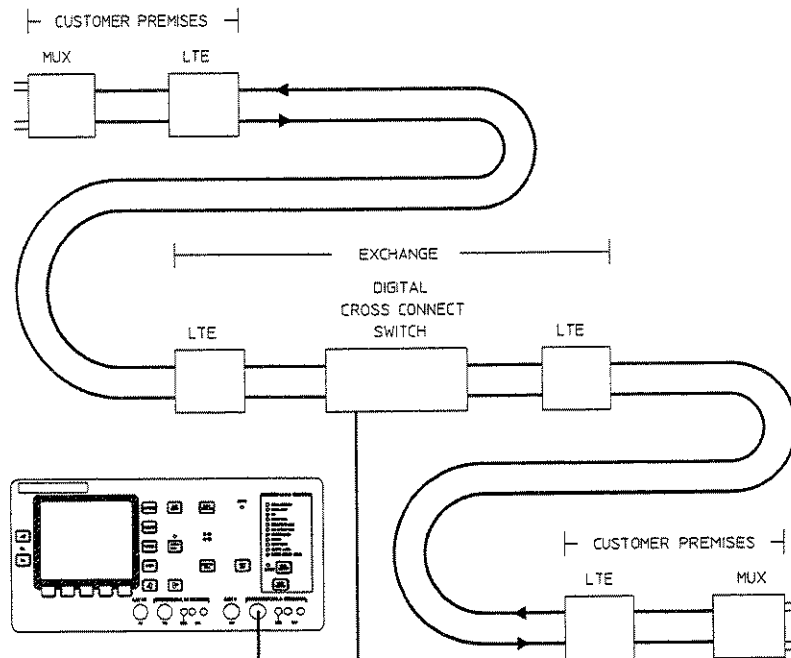

This test may be made at any monitor point in the network.

Press **SETTINGS**.

Set up the test conditions.

Highlight **PATTERN** [].

Select **LIVE DATA**.

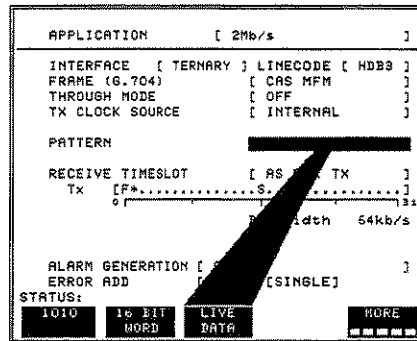

Press **RESULTS**.

Select **BER MEASUREMENTS**.

TROUBLE SCAN.

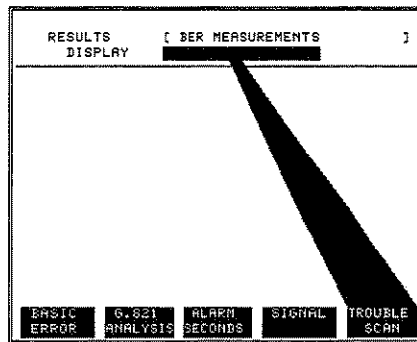

For graphs of error count and alarms / time.

Highlight STORAGE [**STORAGE**].

Select the resolution you want.

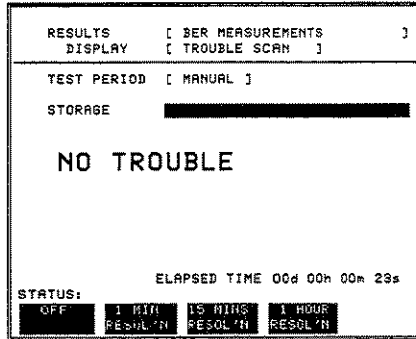

If the trouble scan shows events that you want to investigate, use **GRAPHS**.

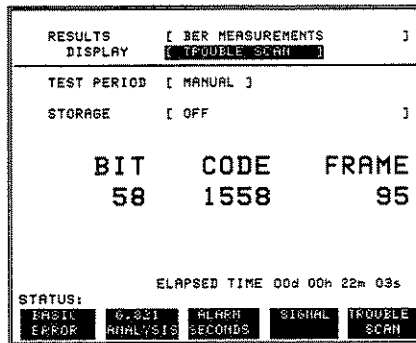

Use **CHANGE UPPER**, **CHANGE LOWER**, **ZOOM IN**, and **ZOOM OUT** to display the events of interest.

The graph controls are described in chapter 4.

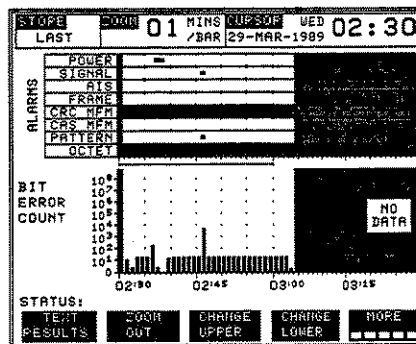

To Isolate the source of errors :

To Find an Idle Timeslot or to look for Stuck Bits (CAS)

Information about which timeslots are in use and which are idle is contained in the CAS signaling bits in timeslot 16. The Telecom Analyzer shows these signaling bits and the timeslots to which they relate.

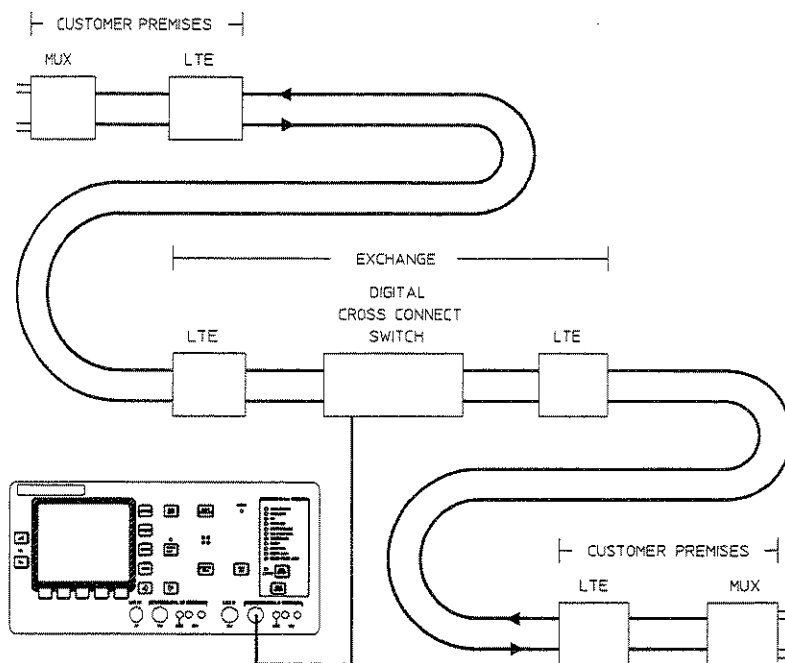

Press **RESULTS**.

Select **TIMESLOT MONITOR**.

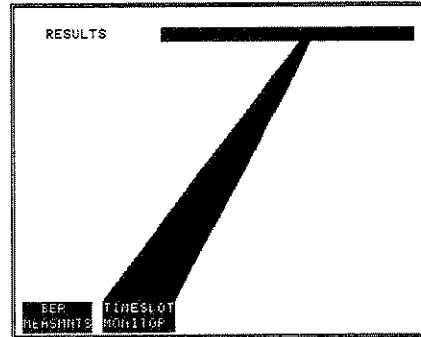

Highlight **DISPLAY** [].

Select **SIGNALING**.

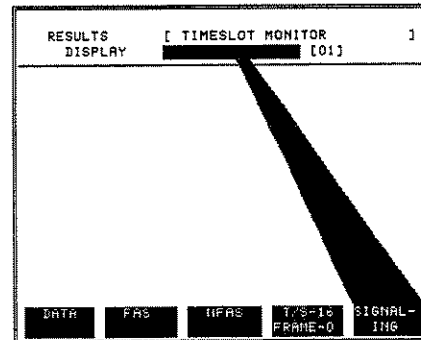

Highlight **DISPLAY SIGNALING** [].

Select **ALL**.

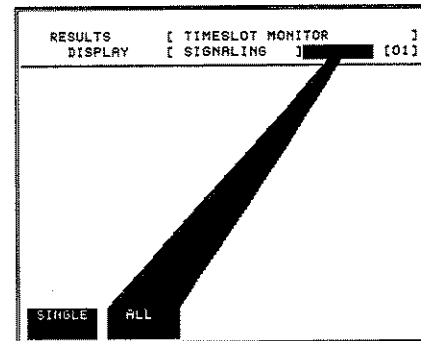

The timeslot 16 signaling bits relating to each timeslot are displayed.

RESULTS		[TIMESLOT MONITOR]	
DISPLAY		[SIGNALING]	
Timeslots 1-15,17-31 signaling bits					
	ABCD		ABCD		ABCD
01	0101	09	0101	17	0101
02	0101	10	0101	18	0101
03	0101	11	0101	19	0101
04	0101	12	0101	20	0101
05	0101	13	0101	21	0101
06	0101	14	0101	22	0101
07	0101	15	0101	23	0101
08	0101			24	0101
SPEAKER [OFF]					
STATUS:					
SINGLE		ALL			

To Isolate a Wideband, or Single Timeslot, Error Source

You may make an error measurement on unused timeslots, leaving the other timeslots in service. Tests may be made, with a single analyzer, in each direction from a digital cross connect switch to discover on which side the error source is located. The error source may be further isolated by looping the channel at intermediate points on the bad side.

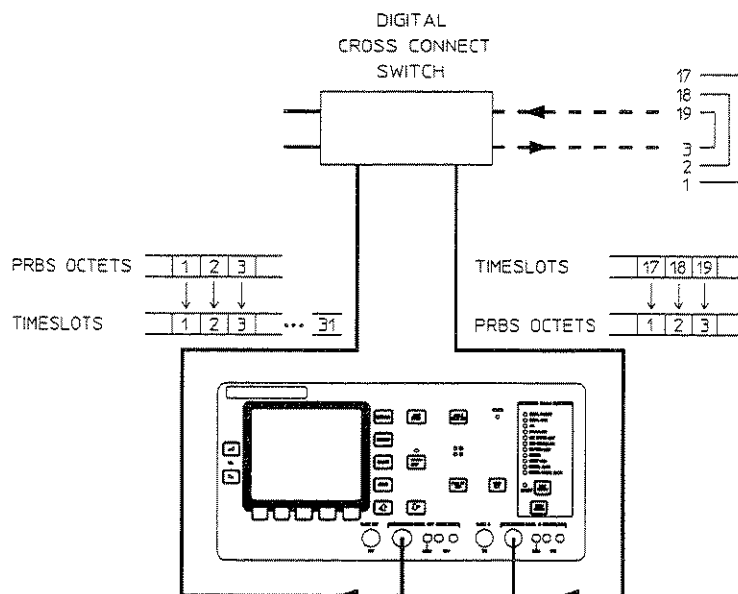

Press **SETTINGS**.

Set up the test conditions.

Highlight **THROUGH MODE** [**ON**].

Select **ON**.

```
APPLICATION      [ 2Mb/s      ]
INTERFACE [ TERNARY ] LINECODE [ HDB3 ]
FRAME (S.704)   [ CAS MFM   ]
THROUGH MODE    [ ON          ]
PATTERN         [ 2111111 ]
RECEIVE TIMESLOT [ SELECT    ]
Tx [ F***..... ]
Rx [ F***..... ]
Bandwidth      384kb/s Rx 384kb/s
ERROR ADD      [ BIT ] [ SINGLE ]
STATUS:
OFF            ON
```

Select the test pattern and timeslots, switch the timeslots into the Telecom Analyzer, loop the channels at the far end and press **START / STOP**.

Press **RESULTS**.

Select **BER MEASUREMENTS**.

All error types are recorded. You may change the form that you want to display them in during the measurement. If in doubt start with **DISPLAY TROUBLE SCAN** to see which type of error occurs and then change to **DISPLAY BASIC ERROR** and select that type of error to display the rate.

```
RESULTS [ BER MEASUREMENTS ]
DISPLAY [                    ]
TEST PERIOD [ MANUAL ]
STORAGE [ OFF ]

BIT      CODE      FRAME
58      1558      95

ELAPSED TIME 00d 00h 22m 03s
STATUS:
BASIC ERROR  0.831 ALARM  SIGNAL  TROUBLE
ANALYSIS    SECONDS  SCAN
```

Alternatively, you may use another analyzer at monitor points down the line to see where errors occur.

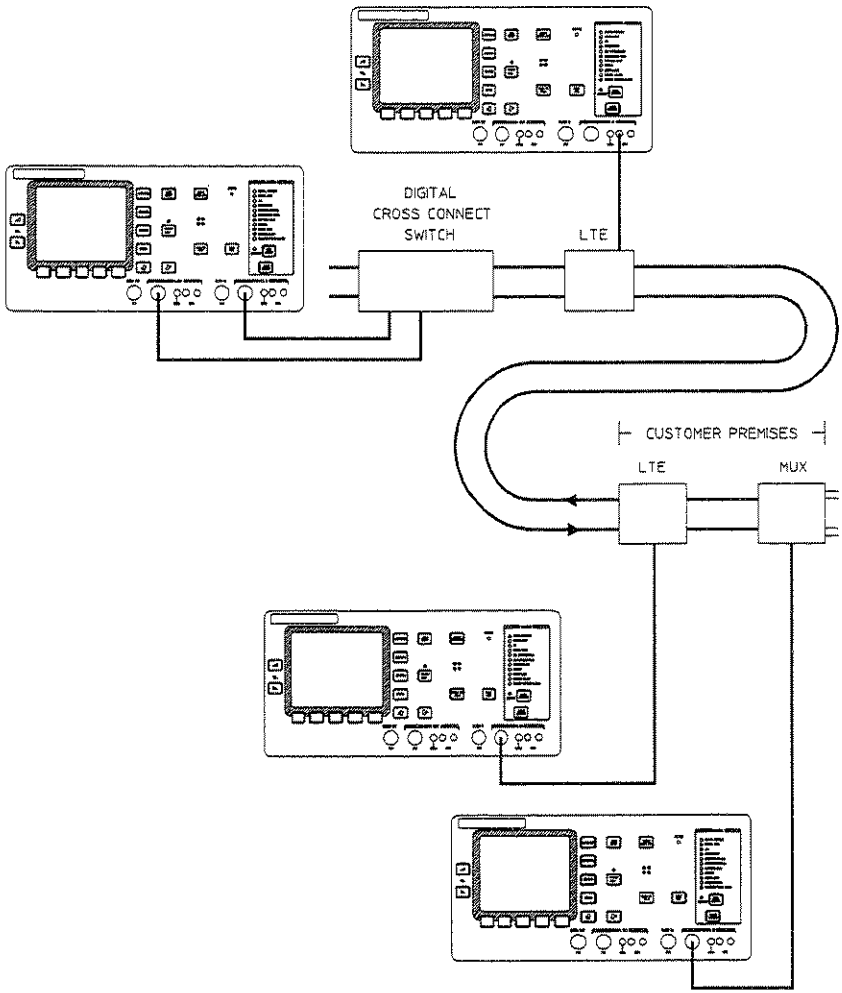

Troubleshooting data from packet-type signaling protocols.

For example #7 signaling.

In this example data from timeslot 16 is routed to a protocol analyzer. The Telecom Analyzer external drop and insert is used for the interface between the protocol analyzer and the 2Mbit/s signal. Note that up to 6 timeslots may be dropped to a protocol analyzer for further analysis on, for example, X.25 or frame relay data.

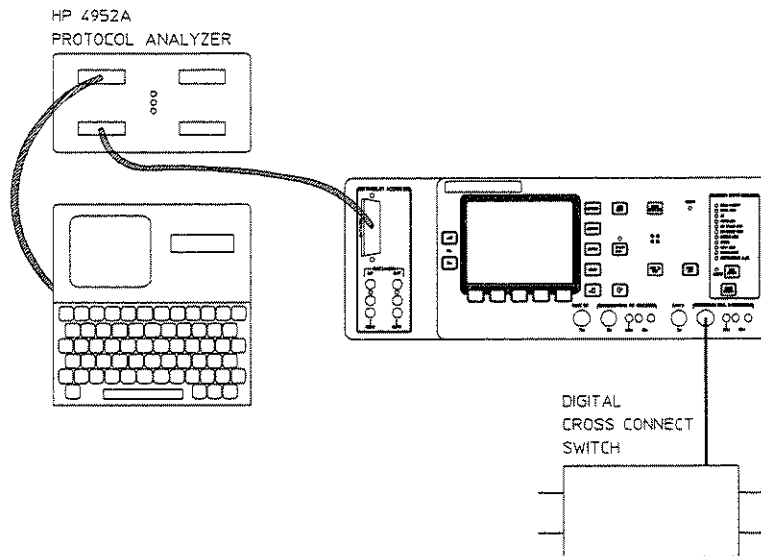

Press **SETTINGS**.

Select **2Mb/s D & I** or **704kb/s D & I**.

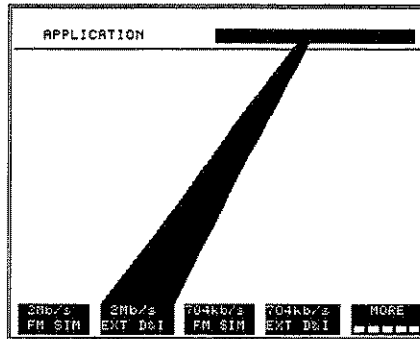

Set up the test conditions.

Highlight **EXTERNAL DROP & INSERT []**.

Select **DATACOM**.

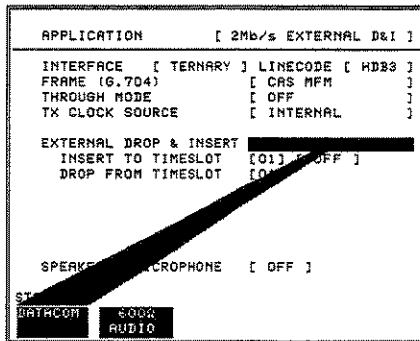

Highlight **DROP FROM TIMESLOT []**.

Select the timeslot to be analyzed.

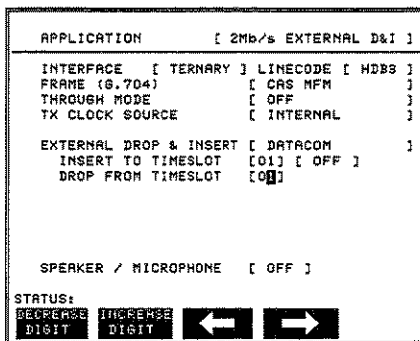

CRC4 Network Performance Evaluation From One Location.

Data transmission quality is indicated by % errored seconds. A good estimate of % errored seconds may be made from CRC block errors.

Go Path Errors

A CRC error detected at the far end causes the returned E bits to be changed to 0 from 1. The E bits are counted and shown as Remote End Block Errors (REBE). REBE indicates the quality of the go path.

Return Path Errors

CRC errors are measured directly at the local end. CRC errors indicate the quality of the return path.

Two tests may be made at an intermediate point in the network, one in each direction, to estimate the overall quality of service or to isolate a source of errors.

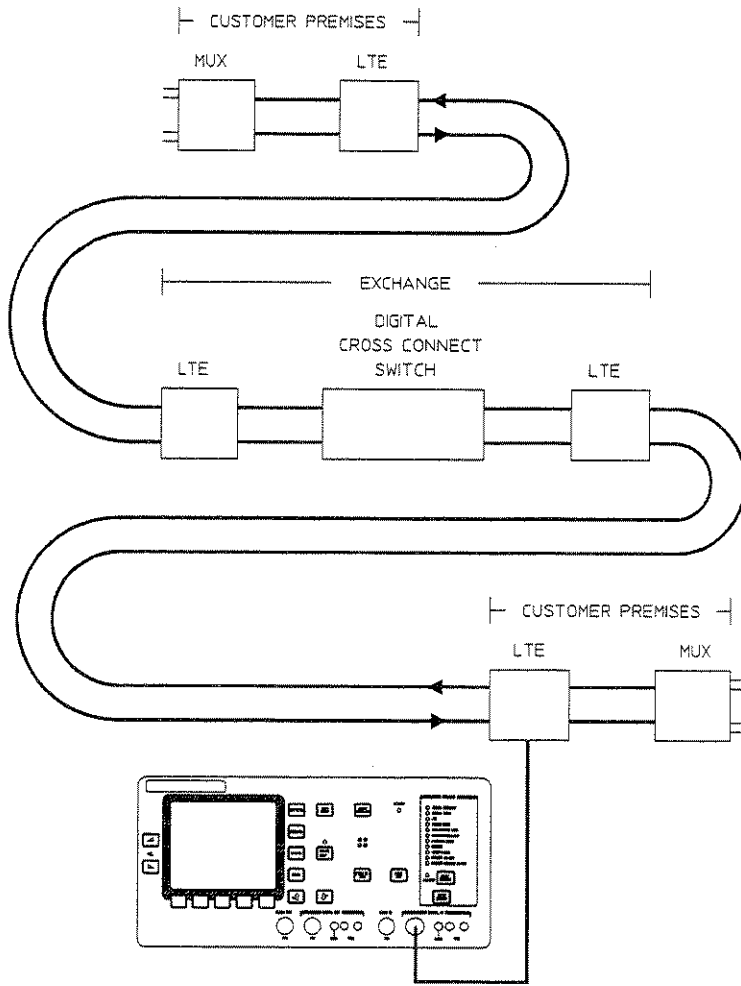

Press **SETTINGS**.

Select **2Mb/s**.

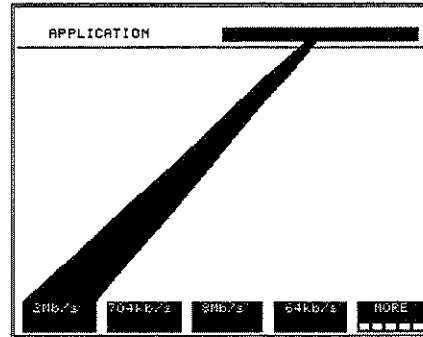

Set up the test conditions.

Highlight **FRAME (G.704)**.

Select **CAS, CRC4 MFM**.

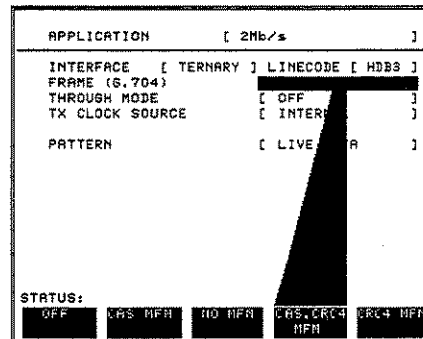

Press **RESULTS**.

Select **BER MEASUREMENTS**.

G.821 ANALYSIS

% ERRORED SECONDS gives a good indication of the bit error performance when measuring low rate remote end block errors.

For another indication, error free seconds select **BASIC ERROR**.

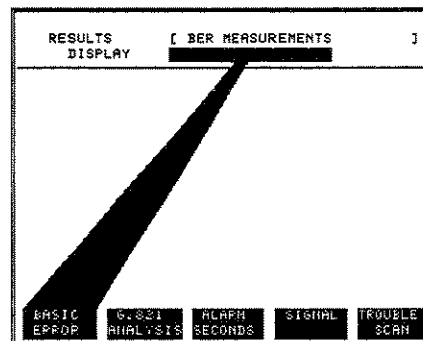

Highlight
DISPLAY G.821 ANALYSIS [1]

For go path test
select REBE

For return path test
select CRC

Press **START / STOP**

RESULTS	[BER MEASUREMENTS]
DISPLAY	[BASIC ERROR]
TEST PERIOD	[MANUAL]
STORAGE	[OFF]
ERRORS
EFS
CURRENT ER
AVERAGE ER
ELAPSED TIME 00d 00h 04m 15s	
STATUS:	
BIT	CODE
FRAME	CRC
REBE	

To Monitor ISDN Error Performance Data in the CRC4 NFAS Word.

The spare national (Sa) bits in the CRC4 NFAS word may be used to carry ISDN error performance information. This information, for example severely errored seconds or degraded minutes is carried in bits 4 to 7 of the NFAS word.

Press **RESULTS**.

Select **TIMESLOT MONITOR**.

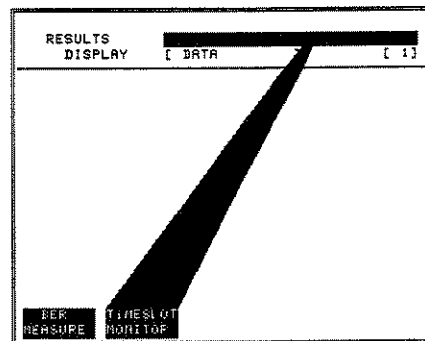

Highlight **DISPLAY** [].

Select **NFAS**.

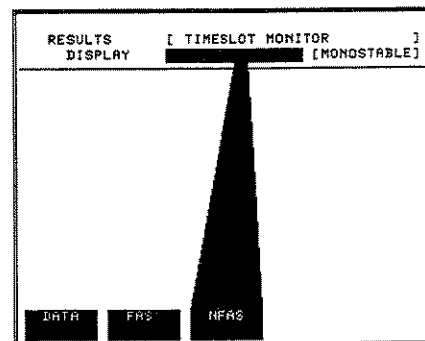

Highlight DISPLAY [NFAS] [**LATCH**].

For regular display update, select **MONOSTABLE**.

To register the first occurrence of change in any one of the bits in one frame, select **LATCH**.

For further analysis, use remote control to record each occurrence and reset.

FRM	T/S-O	LATCH	EVENT TIME
1	01010111	-----
3	01010111	-----
5	11010111	-----
7	01010111	-----
9	11010111	-----
11	11010111	-----
13	11010111	-----
15	11010111	-----

LATCH EVENT [***.....]

(Use RESET HISTORY key to clear)

STATUS:
MONO* **LATCH**
STABLE

To Monitor VF Traffic in Channels

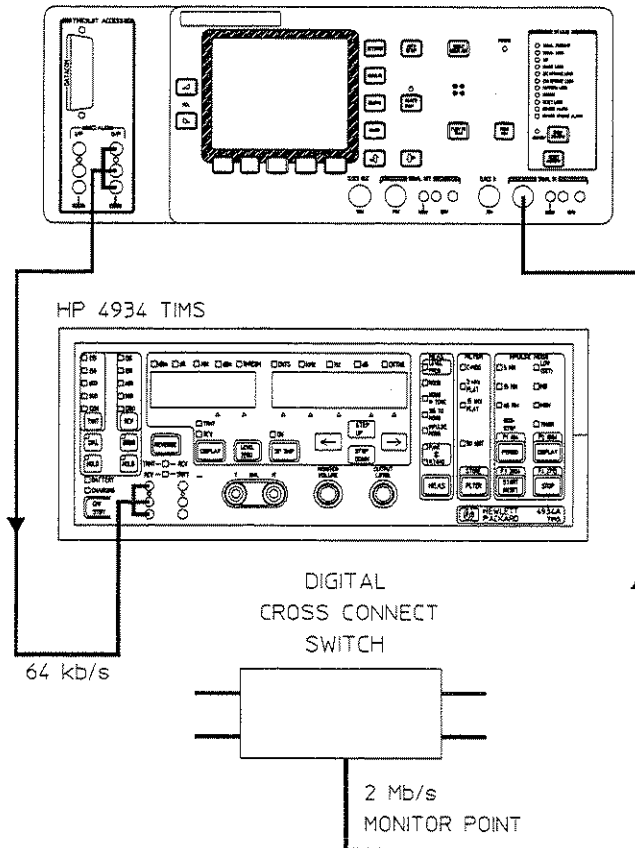

Press **SETTINGS**.

Select **2Mb/s D & I** or **704kb/s D & I**.

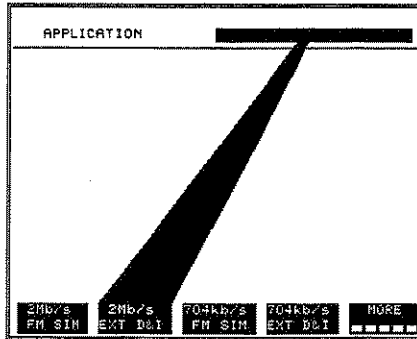

Set up the test conditions.

Highlight **EXTERNAL DROP & INSERT** [].

Select **6000 AUDIO**.

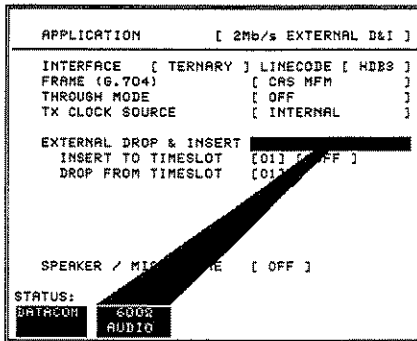

Highlight **DROP FROM TIMESLOT** [].

Select the timeslot to be analyzed.

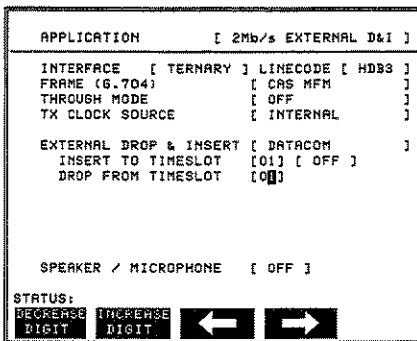

To Monitor Sub-rate Frame and Data Bits

To monitor sub-rate data bits

If a sub-rate, user channel, loopback test fails, you may want to display the data in the channel. The returned data may give an indication of the cause of the trouble. You can look for data being returned, bit shifts or logic inversion at different points in the network.

You need to select the BEARER SET-UP and the SUB RATE SET-UP.

Press **SETTINGS**.

Select **SUB RATE**.

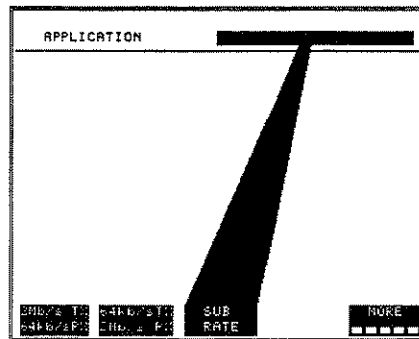

Highlight **DISPLAY** [**7**].

Select **BEARER SET-UP**.

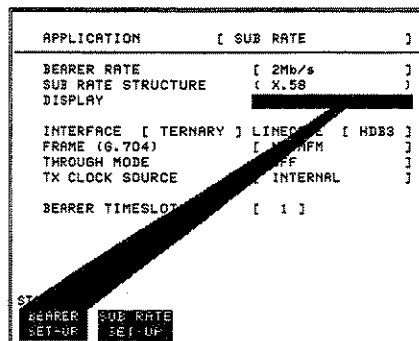

Set the bearer parameters

Select the BEARER TIMESLOT.

```
APPLICATION      [ SUB RATE      ]
-----
BEARER RATE     [ 2Mb/s         ]
SUB RATE STRUCTURE [ X.56         ]
DISPLAY         [ BEARER SET-UP ]
-----
INTERFACE [ TERNARY ] LINECODE [ HDDB3 ]
FRAME (G.704) [ NO MFM         ]
THROUGH MODE [ OFF             ]
TX CLOCK SOURCE [ INTERNAL      ]
-----
BEARER TIMESLOT [ 1 ]

STATUS:
DECREASE INCREASE
DIGIT    DIGIT    [ ← ] [ → ]
```

Highlight DISPLAY [].

Select SUB RATE SET-UP

```
APPLICATION      [ SUB RATE      ]
-----
BEARER RATE     [ 2Mb/s         ]
SUB RATE STRUCTURE [ X.56         ]
DISPLAY         [ SUB RATE SET-UP ]
-----
INTERFACE [ TERNARY ] LINECODE [ HDDB3 ]
FRAME (G.704) [ NO MFM         ]
THROUGH MODE [ OFF             ]
TX CLOCK SOURCE [ INTERNAL      ]
-----
BEARER TIMESLOT [ 1 ]

STATUS:
BEARER SUB RATE
SET-UP  SET-UP
```

Set the sub rate parameters

Highlight CHANNEL AND RATE [].

Select the SUB RATE CHANNEL.

```
APPLICATION      [ SUB RATE      ]
-----
BEARER RATE     [ 2Mb/s         ]
SUB RATE STRUCTURE [ X.56         ]
DISPLAY         [ SUB RATE SET-UP ]
-----
PATTERN         [ 2^11-1       ]
CHANNEL AND RATE [ 1 ]         2.4kb/s
MAPPING
0 - XW.....
20 - .....*
40 - .X.....*
60 - .....
-----
Deselected octets [ 11111111 ]
ERROR ADD [ BIT ] [ SINGLE ]

STATUS:
DECREASE INCREASE
DIGIT    DIGIT    [ ← ] [ → ]
```

Press **RESULTS**.

Select **SUB RATE MONITOR**.

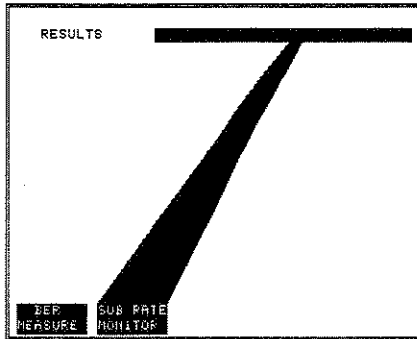

Highlight **DISPLAY** [1].

Select **DATA**.

Highlight **OCTET** [1].

Select the octet you want to display.

You display octets of the sub rate user channel. For example, if the sub rate user channel selected is channel 1 (2.4kb/s), octet 1 shows the data in byte 1, octet 2 shows the data in byte 27 and octet 3 shows the data in byte 54.

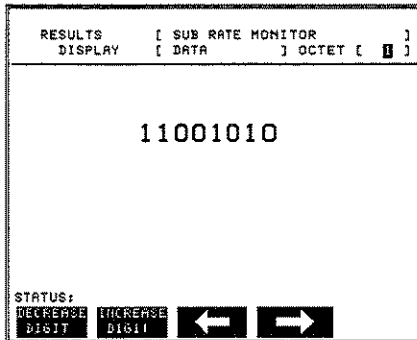

To monitor sub-rate framing

If a trouble scan shows sub-rate frame errors, you may want to display the sub-rate framing bits.

Press **SETTINGS**.

Select **SUB RATE**.

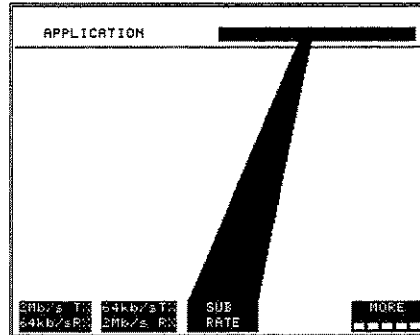

Highlight **DISPLAY** [].

Select **BEARER SET-UP**.

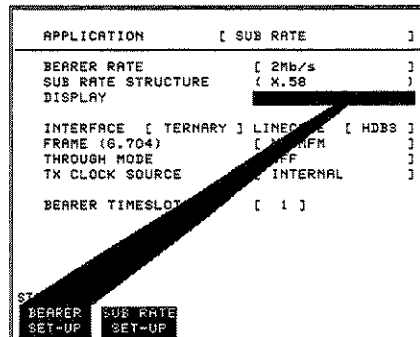

Set the bearer parameters

Select the **BEARER TIMESLOT**.

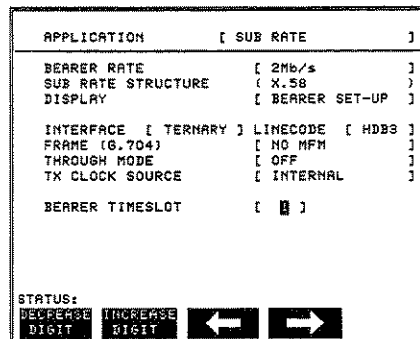

Press **RESULTS**.

Select **SUB RATE MONITOR**.

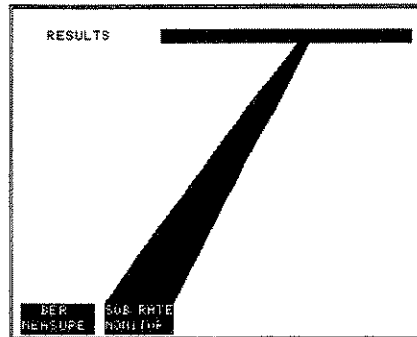

Highlight **DISPLAY** [**↑**].

Select **FAS**.

Highlight **DISPLAY [FAS]** [**↑**].

Select **X1** to display FAS byte 0 or **X2** to display FAS byte 42.

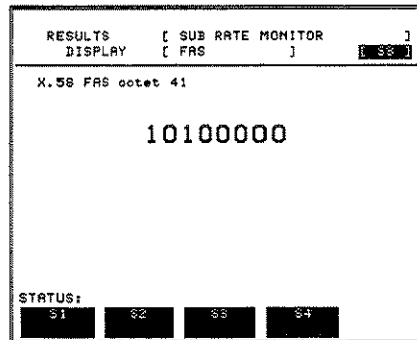

To Run a User Protocol in a Circuit

If you need to test a user channel with a particular protocol, you may insert a sub rate pattern from an external source (for example from a protocol analyzer) into a 64 kbit/s bearer or a 2 Mbit/s data stream and drop the returned sub rate pattern for analysis.

Press **SETTINGS**.

Select **SUB RATE**.

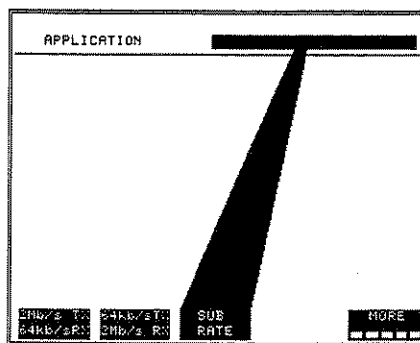

Highlight **DISPLAY** [].

Select **BEARER SET-UP**.

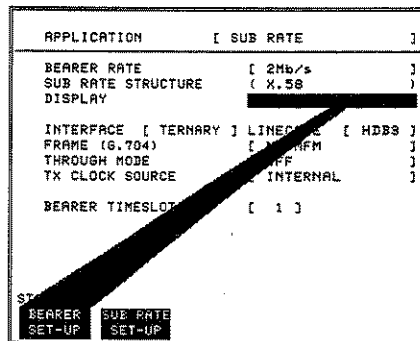

Set the bearer parameters. To maintain service on the other sub rate channels, set the THROUGH MODE to ON.

Select the BEARER TIMESLOT.

APPLICATION	[SUB RATE]
BEARER RATE	[2Mb/s]
SUB RATE STRUCTURE	[X.58]
DISPLAY	[BEARER SET-UP]
INTERFACE [TERNARY]	LINECODE [HDB3]
FRAME (S.704)	[NO MFM]
THROUGH MODE	[ON]
BEARER TIMESLOT	[1]

STATUS:
DECREASE INCREASE
DIGIT RIGHT ← →

Highlight DISPLAY [].

Select SUB RATE SET-UP

APPLICATION	[SUB RATE]
BEARER RATE	[2Mb/s]
SUB RATE STRUCTURE	[X.58]
DISPLAY	[BEARER SET-UP]
INTERFACE [TERNARY]	LINECODE [HDB3]
FRAME (S.704)	[NO MFM]
THROUGH MODE	[ON]
BEARER TIMESLOT	[1]

STATUS:
BEARER SUB RATE
SET-UP SET-UP

Highlight PATTERN [1].

Select DATACOM D & I

```
APPLICATION      [ SUB RATE      ]
BEARER RATE     [ 2Mb/s        ]
SUB RATE STRUCTURE [ X.58        ]
DISPLAY         [ SUB RATE SET-UP]
PATTERN
CHANNEL AND RATE [ 1 ] 2.4kb/s
MAPPING
0 - X*.....
20 - .....
40 - X*.....
60 - .....
STATUS:
211-1  209-1  16 BIT  DATACOM
MOPD   MOPD   MOPD   D&I
```

Highlight CHANNEL AND RATE [1].

Select the SUB RATE CHANNEL.

```
APPLICATION      [ SUB RATE      ]
BEARER RATE     [ 2Mb/s        ]
SUB RATE STRUCTURE [ X.58        ]
DISPLAY         [ SUB RATE SET-UP]
PATTERN         [ DATACOM D&I ]
CHANNEL AND RATE [ 1 ] 2.4kb/s
MAPPING
0 - X*.....
20 - .....
40 - X*.....
60 - .....
STATUS:
DECREASE INCREASE
DIGIT   DIGIT   ←   →
```

Connect the protocol analyzer to the DATACOM port on the side of the tester.

Full Measurement List

Any time that the analyzer is connected :

Received frequency
Received frequency offset

Timeslot monitor :

Data, FAS, NFAS, frame 0 timeslot 16
CAS Signaling (timeslot 16 signalling associated with one or all timeslot ABCD bits).

When a test is running:

Measurement

Errors :

Error count
Error free seconds
% Error free seconds
Current error ratio
Average error ratio

Unavailability, %unavailability
Errored seconds, % errored seconds
Severely errored seconds, % severely errored seconds
Degraded minutes, % degraded minutes
Long term mean error ratio

Received Rate	Type of Error				
	Bit	Code	Frame	CRC	REBE
8Mbit/s	*	*			
2Mbit/s	*	*	*	*	*
704kbit/s	*	*	*		
64kbit/s	*				

Alarm Seconds :

- Power loss
- Signal loss
- AIS
- Frame loss
- CRC multiframe loss
- CAS multiframe loss
- Pattern loss
- Octet loss (64 kbit/s)
- Remote alarm
- Remote multiframe alarm

Round trip (absolute) delay ($2^{23}-1$ PRBS)

- Change Of Frame Alignment (COFA)
- Pattern slips

Tx/Rx rates

Tx	Rx	
8Mbit/s	8Mbit/s	(optional)
2Mbit/s	2Mbit/s	Drop and insert selectable pattern
		Multi-timeslot ($n \times 64\text{kbit/s}$)
		Rx timeslot(s) selectable or "as Tx"
2Mbit/s	2Mbit/s	Drop and insert external signal
		(optional)
2Mbit/s	64kbit/s	
704kbit/s	704kbit/s	Drop and insert selectable pattern
		(optional)
		Rx timeslot(s) selectable or "as Tx"
704kbit/s	704kbit/s	Drop and insert external signal
		(optional)
64kbit/s	2Mbit/s	
64kbit/s	64kbit/s	

Investigating the Source of Slips

Where voice / FAX circuits are being dropped or leased data circuits are experiencing bursts of errors and the local PABX is local timed, you can check the frequency offset between the incoming timing and the local timing. A frequency difference may be resulting in controlled slips which are causing these effects.

The measurement result may be displayed in terms of relative frequency offset, wander or estimated bit slips.

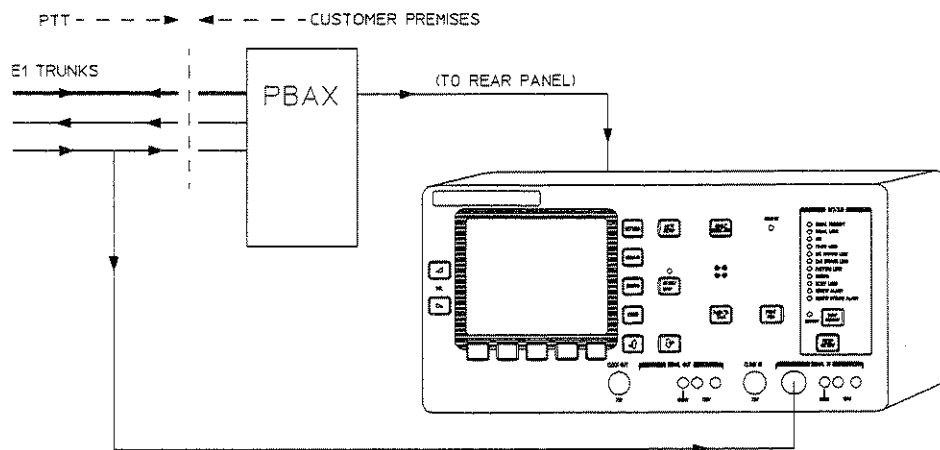

At the near end.

Press **RESULTS**.

Select **BER MEASUREMENTS**

Highlight **DISPLAY** []

Select **SIGNAL**

RESULTS DISPLAY	[BER MEASUREMENTS]
TEST PERIOD	[MANUAL]
STORAGE	[OFF]
TONE FREQUENCY	1008 Hz
TONE LEVEL	-15.0 dBm0
CODER OFFSET	0
MAX POSITIVE	+79
MAX NEGATIVE	-79
ELAPSED TIME	00m 00s
STATUS:	
BASIC ERROR	9.821 ANALYSIS SECONDS
	SIGNAL TROUBLE
	SCAN

Highlight **MEASUREMENTS** []

Select **GATED** (with **TEST PERIOD** setting) for gated COFA, Pattern slips, Peak wander and Bit slips.

RESULTS DISPLAY	[BER MEASUREMENTS]
	[SIGNAL]
TEST PERIOD	[MANUAL]
STORAGE	[OFF]
MEASUREMENTS	[GATED]
COFA
PATTERN SLIPS
	POSITIVE NEGATIVE
WANDER PEAK UI UI
BIT SLIPS
ELAPSED TIME	..d ..h ..m ..s
STATUS:	
NON-GATED	GATED

Select **NON-GATED** for frequency comparisons and a graphical indication of wander.

RESULTS DISPLAY	[BER MEASUREMENTS]
	[SIGNAL]
TEST PERIOD	[MANUAL]
STORAGE	[OFF]
MEASUREMENTS	[NON-GATED]
RX FREQUENCY	0 Hz
OFFSET REF. INTERNAL	U/R ppm
REF. EXTERNAL	OVER/R ppm
-256UI -128UI 0UI +128UI +256UI	
-16UI -8UI 0UI +8UI +16UI	
NO INPUT SIGNAL	
NO INPUT SIGNAL	
ROUND TRIP DELAY	N/A
STATUS:	
NON-GATED	GATED

4

Displaying Error and Alarm Test Results

When you run an error test, all results are recorded.

- You can display an alarm history.
- You can display results in numeric or graphic form.
- You can display results of the current/last test.
- You can display the stored results of a previous test.

To Display Alarms

The current alarm conditions are always displayed when the telecom analyzer is connected to the telecom line.

One or more occurrences of an alarm during a test, since the last history reset, may be displayed at any time until the start of the next test.

A record of total alarm durations may be displayed during or after a test at any time until the start of the next test.

A graphic representation of alarms may be displayed (see To Display Alarm and Error Graphs).

Alarm displays for previously stored results may be recalled (see To Display Stored Results).

To See the Current Alarm Conditions.

The current alarm conditions are always displayed on the STATUS INDICATORS.

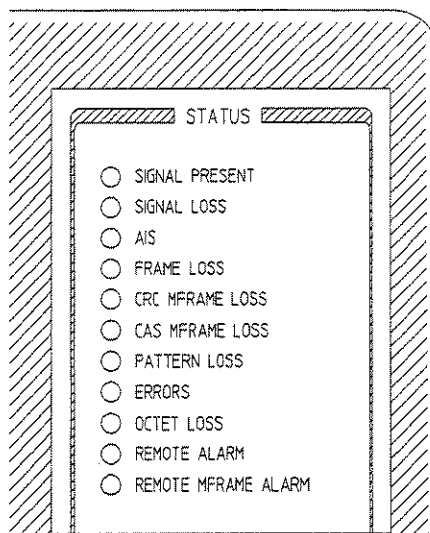

To See the Alarm History

You can run an unattended test and use alarm history to see if any alarms occurred while you were away.

The occurrence of alarms since the start of a test with **START STOP** or since a history reset during a test, is shown while **SHOW HISTORY** is held down.

To clear this record press **HISTORY RESET**.

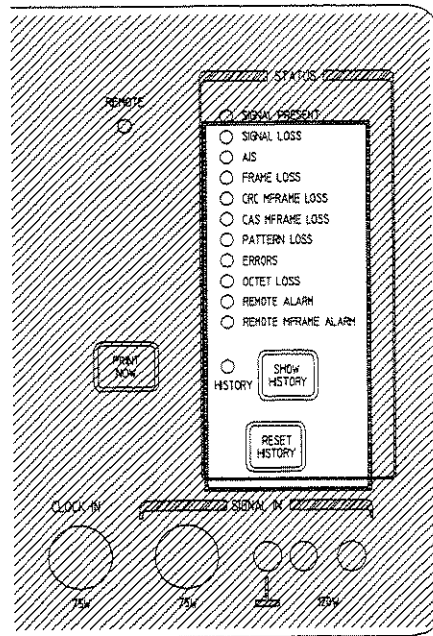

To See the Record of Total Alarm Durations.

This record is the total of each type of alarm since the start of the test. The record is reset at the start of each test. The stored results of up to ten tests may be displayed (see To Display Alarm and Error, Graphs) and (To Display Stored Results).

Press **RESULTS**.

Select **BER MEASUREMENTS**

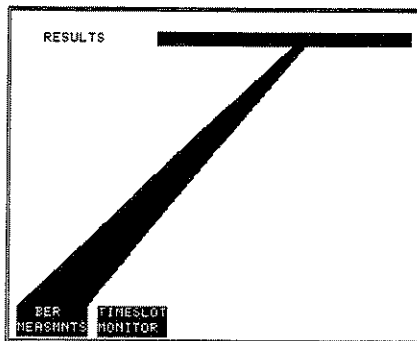

Highlight **DISPLAY** []

Select **ALARM SECONDS**.

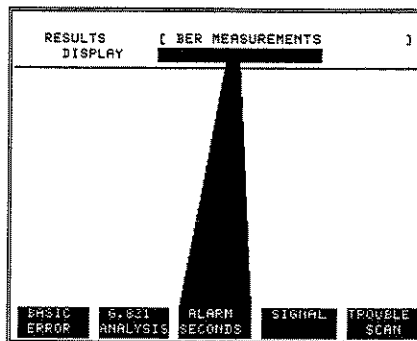

4-4 Displaying Error and Alarm Test Results

To Display Errors

When you run a test, all errors are measured and recorded. You chose how you want to display them. The display can be changed, at any time, during and after the test. The record is reset at the start of each test.

The results of up to ten tests may be stored.

The choice of display at any one time is :

1. A display of the error count of each error type **TROUBLE SCAN**:
 - a. Bit Error Count.
 - b. Code Count.
 - c. Frame Error Count.
 - d. CRC Error Count.
 - e. REBE Error Count.
2. A display of the basic results of one error type in large characters (Bit, Code, Frame, CRC, or REBE) **BASIC RESULTS**:
 - a. Error Count.
 - b. Error Free Seconds Count.
 - c. Current Error Ratio.
 - d. Average Error Ratio.
3. The G.821 analysis of one error type (Bit, Frame, CRC or REBE) **G.821 ANALYSIS**:
 - a. Unavailability
 - b. Errored Seconds
 - c. Severely Errored Seconds
 - d. Degraded Minutes
 - e. LTMER
4. Bar charts of error count updated at selected intervals during the test **GRAPHS** (see To Display Alarm and Error, Graphs).
5. A complete set of results for the previous ten tests in graphic and numeric form including G.821 analysis (see To Display Stored Results).

To Select One of the Error Displays

Press **RESULTS**

Select **BER MEASUREMENTS**

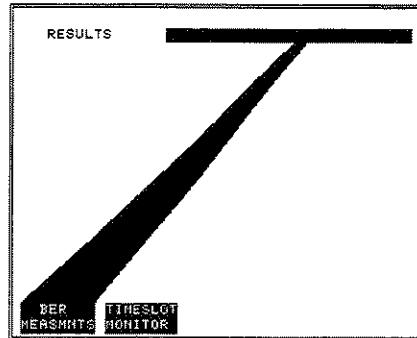

To Display the Error Count of Each Error Type

Highlight **DISPLAY []**

Select **TROUBLE SCAN**

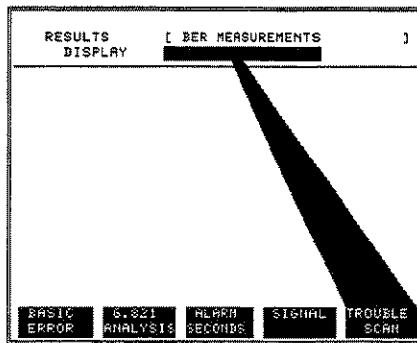

4-6 Displaying Error and Alarm Test Results

To Display Details of One Error Type

Select **BASIC ERROR**.

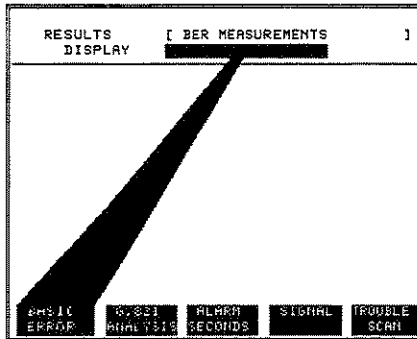

Highlight **DISPLAY [BASIC ERROR]**
[]

Select the type of error you want to display.

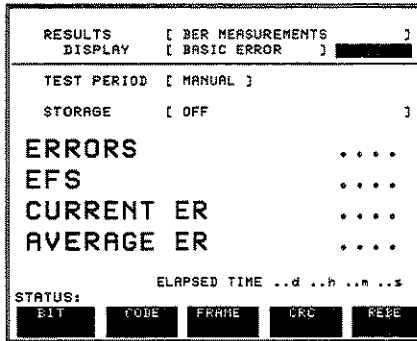

For a G.821 Analysis Display of One Type Of Error

Select **G.821 ANALYSIS**.

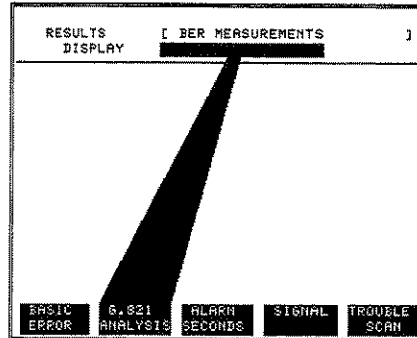

Highlight
DISPLAY [G.821 ANALYSIS]
[]

Select the type of error you want to display.

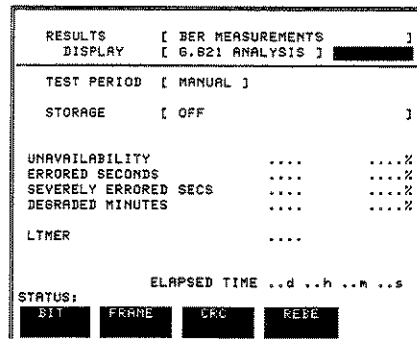

For an M21XX Analysis (Bringing into Service)

Press **RESULTS**

Select **M21XX ANALYSIS**

RESULTS	[BER MEASUREMENTS]
DISPLAY	[M.21XX ANALYSIS] [M.2100]
TEST PERIOD	[MANUAL]
STORAGE	[OFF]
IN-SERVICE	RX TX
ERRORED SECONDS
SEVERELY ERRORED SECS
UNAVAILABILITY
OUT-OF-SERVICE	RX
ERRORED SECONDS
SEVERELY ERRORED SECS
UNAVAILABILITY
ELAPSED TIME ..d..h..m..s	
STATUS:	
PROBLE	M.2100
SEARCH	NUM. 518
	MORE

Highlight

DISPLAY [M21XX ANALYSIS] []

Select M2110

The pass/fail limits are automatically selected when you set PATH ALLOCATION.

RESULTS	[BER MEASUREMENTS]
DISPLAY	[M.21XX ANALYSIS] [M.2110]
TEST PERIOD	[MANUAL]
STORAGE	[OFF]
PATH ALLOCATION	[10.0%]
LIMITS	24-hour 7-day
ES-S1	147 1210
ES-S2	199 1210
SES-S1	0 30
SES-S2	8 30
PASS/FAIL
ELAPSED TIME ..d..h..m..s	
STATUS:	
M.2100	M.2110
	M.2120

For an M21XX Analysis (In Service)

Select **M21XX ANALYSIS**.

RESULTS	[BER MEASUREMENTS]
DISPLAY	[M.21XX ANALYSIS] [M.2100]
TEST PERIOD	[MANUAL]
STORAGE	[OFF]
IN-SERVICE	RX TX
ERRORED SECONDS
SEVERELY ERRORED SECS
UNAVAILABILITY
OUT-OF-SERVICE	RX
ERRORED SECONDS
SEVERELY ERRORED SECS
UNAVAILABILITY
ELAPSED TIME	..d ..h ..A ..s
STATUS:	
TRouble	N.21XX
SCAN	ANALYSIS
	NOPE

Highlight
DISPLAY [M21XX ANALYSIS] []

Select M2120.

The pass/fail limits are automatically
selected when you set PATH
ALLOCATION.

RESULTS	[BER MEASUREMENTS]
DISPLAY	[M.21XX ANALYSIS] [M.2120]
TEST PERIOD	[MANUAL]
STORAGE	[OFF]
PATH ALLOCATION	[10.0%]
	TR1 TR2
	15-minute 24-hour
LIMITS	ES 120 173
	SES 15 4
REPORTS	RX TX

ELAPSED TIME	..d ..h ..M ..s
STATUS:	
	M.2100 M.2110 M.2120

To Display Signal Results

Select **SIGNAL**.

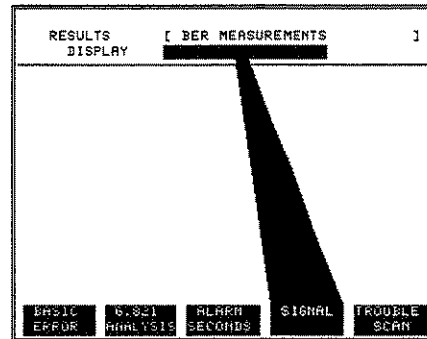

You should see

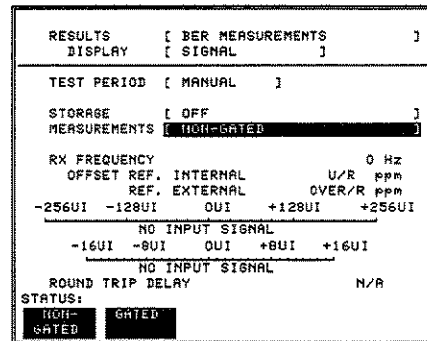

To Display Alarm and Error Graphs

During and after a test you can display all graphs (any two simultaneously) from the following list :

- All alarms.
- Bit error count.
- Code error count.
- Frame error count.
- CRC error count.
- REBE error count.

The graphs make it easy to see how errors and alarms relate to each other and to time of day. Knowing the time pattern of errors often helps point to their cause.

The resolution of the graphs is limited to the value selected when they were stored.

To Select One of the Graphic Displays

To display results as graphs, a storage resolution must be selected before the start of the test

Press **GRAPHS**.

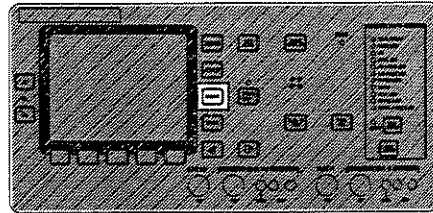

Select the displays you want with **CHANGE UPPER** and **CHANGE LOWER**.

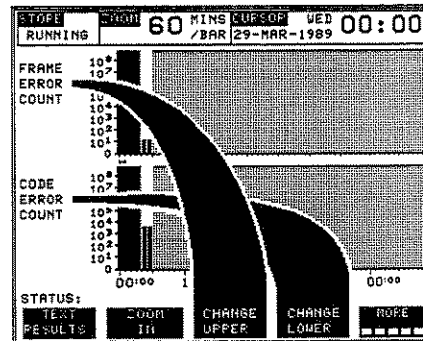

To Select the Time “Window” and Resolution of the Graphic Display

Select the time “window” with **←** and **↵**

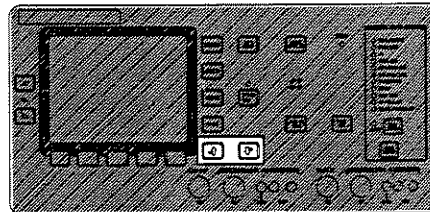

The start time of the cursor left hand edge is shown in the CURSOR box.

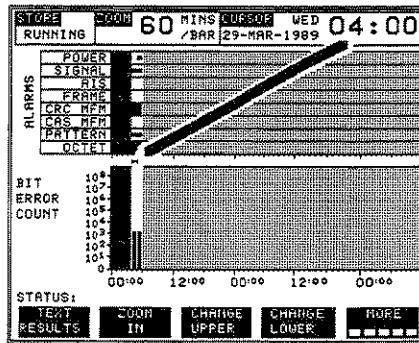

Select the resolution with **ZOOM IN** **ZOOM OUT**.

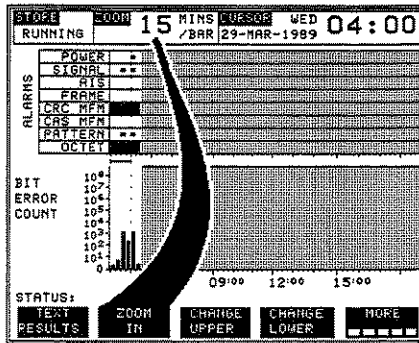

To Return to the Normal Measurement Display

Press **RESULTS**.

To Display Stored Results

A storage resolution must have been selected at test setup.

You can display the following details of previously stored tests :

- The alarms.
- The bit, code, frame, CRC and REBE errors.
- G.821 analysis
- The alarms and error counts in graphical form.
- The receiver settings used.
- The test date and time.

You do not need to carry a printer around. You can store the results and process them later.

To Display One of the Stored Results.

Press **GRAPHS**.

Select **TEXT RESULTS**.

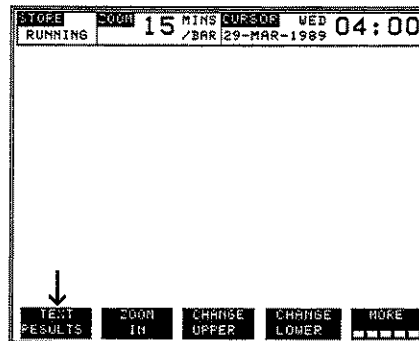

Select **STORE STATUS**.

STORE	START	04:39	STOP	04:42
LAST - 2	SUN	2-APR-1989	SUN	2-APR-1989
HP87722A RECEIVER SETTINGS				
APPLICATION				2Mb/s
INTERFACE				TERNARY HDB3
FRAME (G.704)				CAS MFM
PATTERN				2^23-1
T/SLOT	F*	S.....	

↓

STORE STATUS	GRAPH RESULTS	PRINT	PREV PAGE	NEXT PAGE
---------------------	---------------	-------	-----------	-----------

Use **←** and **↓** to highlight the test result you want to display.

Select **GRAPH RESULT** or **TEXT RESULT**.

STORE	START DATE	START TIME	TEST DURATION	STORE USE
-9T	30-MAR-1989	04:26	00d 00h 01m	<1%
-8T	2-APR-1989	03:07	00d 00h 01m	<1%
-7T	2-APR-1989	03:08	00d 00h 01m	<1%
-6T	2-APR-1989	03:09	00d 00h 01m	<1%
-5T	2-APR-1989	03:09	00d 00h 01m	<1%
-4T	2-APR-1989	03:10	00d 00h 01m	<1%
-3T	2-APR-1989	03:10	00d 00h 02m	<1%
-2T	2-APR-1989	04:39	00d 00h 03m	<1%
-1T	2-APR-1989	04:42	00d 00h 01m	<1%
DEMO	4-APR-1989	04:49	00d 01h 47m	5%
TOTAL			USED 00d 01h 59m	6%
			FREE 01d 08h 09m	94%

↓

GRAPH RESULTS	TEXT RESULTS	DELETE STORE	DELETE ALL
----------------------	--------------	--------------	------------

4-16 Displaying Error and Alarm Test Results

Graphic Display - to Select Error Type or Alarms

see Page 4-10.

Numeric Display - to Select Error Type or Alarms

Use **PREV PAGE** / **NEXT PAGE** to scroll through the displays.

STORE	START	04:39	STOP	04:42
LAST - 2	SUN	2-APR-1989	SUN	2-APR-1989
HP37722A RECEIVER SETTINGS				
APPLICATION			2Nb/s	
INTERFACE			TERNARY HD88	
FRAME (6.704)			CAS MFM	
PATTERN			2^29-1	
T/SLOT	F*S.....		
STORE STATUS	GRAPH RESULTS	PRINT	PREV PAGE	NEXT PAGE

To Return to the Normal Measurement Display

Press **RESULTS**.



Printing Results

To print results, you need to select one of the printing functions of the RS-232 connector.

The Telecom Analyzer can be set to provide an RS-232 output to any one of three types of printer:

1. Any Hewlett-Packard 80 column printer (recommended type HP 2225D).
2. An alternative type which may be:
 - a. Any other 80 column printer.
 - b. A 40 column printer which is capable of handling 80 column condensed format.

Connect the printer to the RS-232 port with a 1:1 RS-232 cable. Additional information is given in Installation, chapter 7.

To Select the Printer Output.

An output suitable for the printer being used, must be selected before any print operation can be performed.

To Select an Output Suitable for a Hewlett-Packard 80 Column Printer.

Press **OTHER**.

Select **RS232 PORT**.

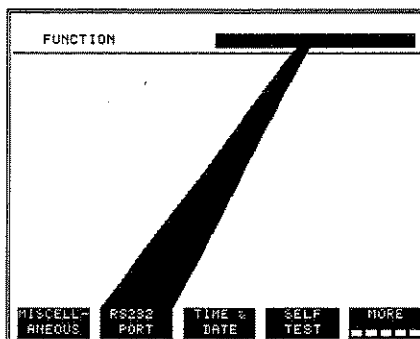

Highlight
RS232 [].

Select **HP PRINTER**.

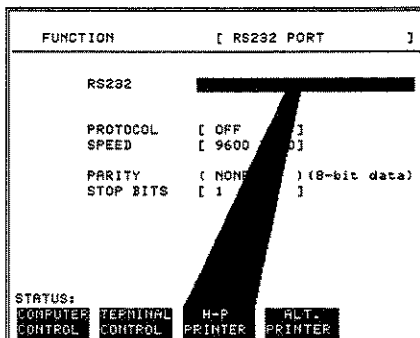

5-2 Printing Results

Example Set-Up Using a Hewlett-Packard Thinkjet Printer, Model 2225D.

To make the printer and Telecom Analyzer compatible, the switches on the rear panel of the printer, MODE and RS-232, and the settings on the Telecom Analyzer AUX, PRINTER / REMOTE CONTROL display must be compatible.

The following example gives one set of compatible settings and the information necessary to select alternatives.

Printer

Printer MODE and RS-232 Settings

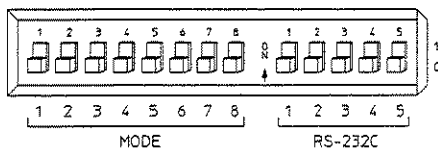

Telecom Analyzer

Compatible Telecom Analyzer AUX
PRINTER / REM CTL display.

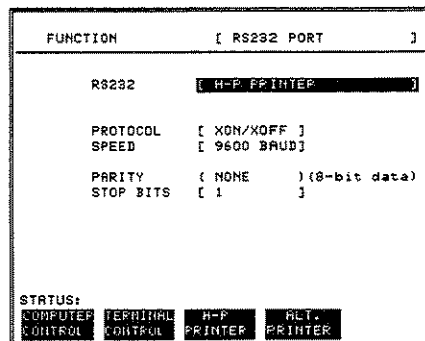

- The MODE switches :
- 1,2 and 5 = 0 : for all interfaces.
 - 3 = 0 : no perforation skip.
 - 4 = 0 : 11 inch paper length.
 - 4 = 1 for 12 inch.
 - 6, 7 and 8 = 0 : ROMAN characters.

- The RS-232 switches :
- 1 = 0 : XON/XOFF.
 - 1 = 1 for DTR set.
 - 2,3 = 0 : parity none / 8 bit data .
 - 2,3 = 0 : zero / 7 bit data .
 - 2,3 = 0,1 odd / 7 bit data,
 - 2,3 = 1,0 even / 7 bit data,
 - 2,3 = 1,1 one / 7 bit data.
 - 4,5 = 0 : 9600 baud.
 - 4,5 = 0,1 19200 baud,
 - 4,5 = 1,0 2400 baud,
 - 4,5 = 1,1 1200 baud.

To Select an Output Suitable for an Alternative Printer.

Press **OTHER**.

Select **RS232 PORT**.

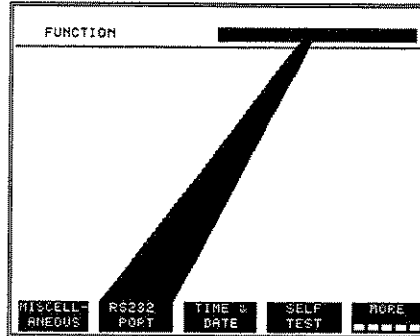

Highlight **RS232 MODE []**.

Select **ALT. PRINTER**.

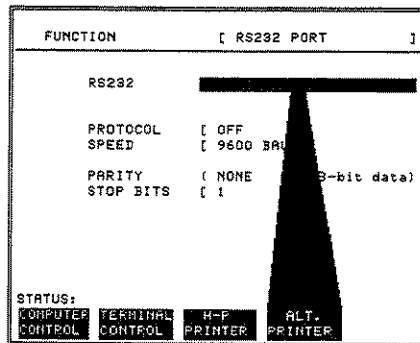

Highlight **PRINT STYLE []**.

For an 80 column printer select **NORMAL**.

For a 40 column Printer select **COMPRESS**.

Set the **PROTOCOL**, **SPEED**, **PARITY** and **STOP BITS** to be compatible with the printer being used.

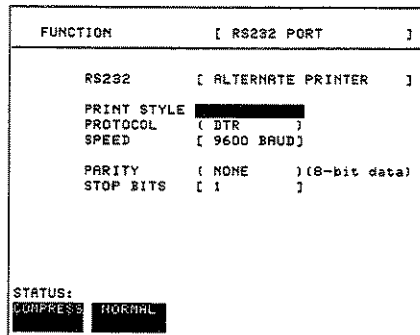

5-4 Printing Results

To Print

You may print any of the following :

- The results of the current or last test as a numeric list.
- The results of the current test at timed intervals. (Option 210 Only)
- The results of the last test as graphs of alarms and error count.
- The stored results of previous tests.
 - As numeric lists.
 - As graphs of alarms and error count.

To Print The Results of the Current / Last Test

To Print the Results of the Current / Last Test as a Numeric List

Press **PRINT NOW**.

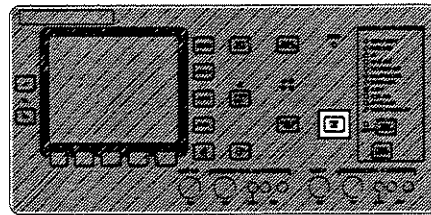

To Print The Results of the Current Test at Timed Intervals

(Option 210 only)

Press **OTHER**.

Select **MISCELLANEOUS**.

Highlight **AUTO TRIGGERED PRINT** [**ENTER**].

Select the print interval you want.

To Print the Results of the Last Test as Graphs of Alarms and Error Count

What you get is what you see plus alarms.

The general procedure is:

Get the result of the test as a graphic display.

Select the pair of error result graphs to be printed.

Select the time period and display resolution using cursor and zoom.

Press **PRINT**.

Three graphs are printed. The two selected plus a graph of alarms.

If alarms are displayed and there is another valid error count, an additional graph will be printed.

NOTE: The resolution available depends on the storage resolution selected at the time of the test.

Press **GRAPHS**.

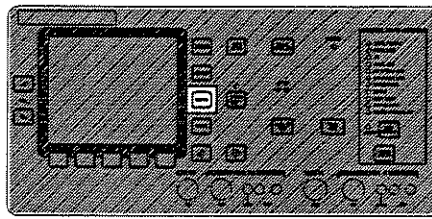

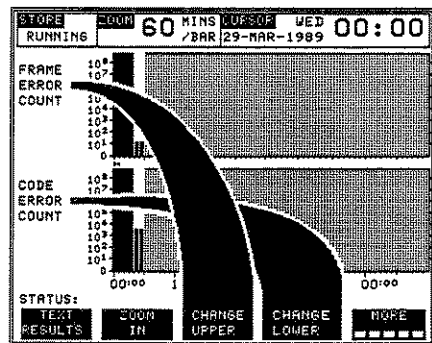

Display the graphs to be printed using **CHANGE UPPER** and **CHANGE LOWER**.

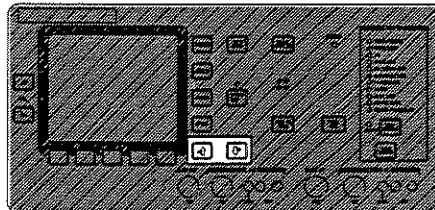

Select the time "window" with **←** and **↓**



5-6 Printing Results

Move the cursor (between the graphs) to the time period you want using  and .

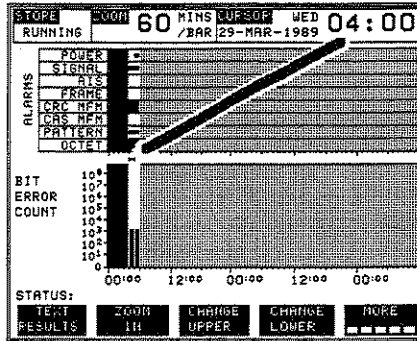

Select the resolution you want with **ZOOM IN / ZOOM OUT**.

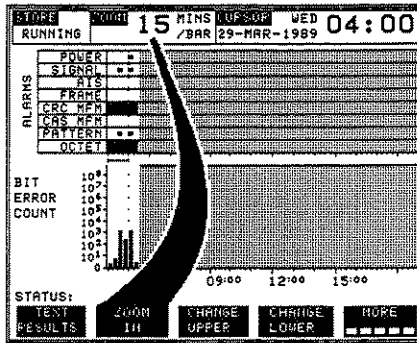

Select **PRINT**.

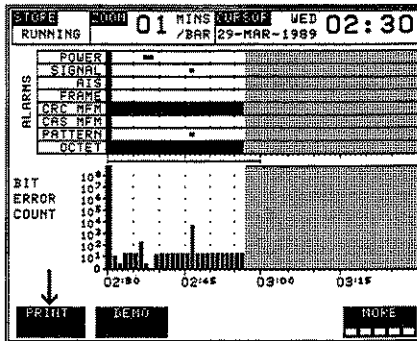

Select a print of the displayed screen
THIS SCREEN or set the cursor to where
you want the print to start and print the
remainder of the graph with
CURSOR TO END.

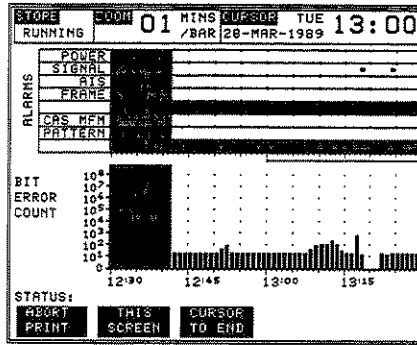

5-8 Printing Results

To Print Stored Results

Press **GRAPHS**.

Select **TEXT RESULTS**.

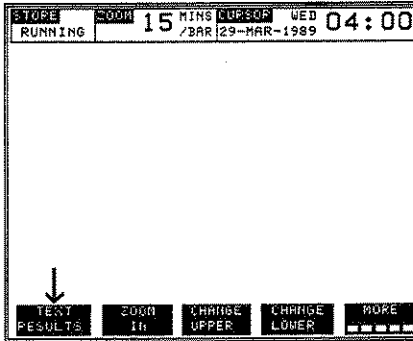

Select **STORE STATUS**.

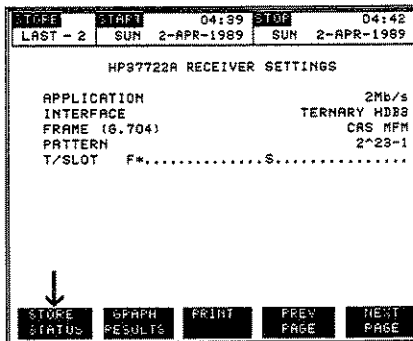

Use **←** and **↓** to highlight the test result to be printed.

STORE	START DATE	START TIME	TEST DURATION	STORE USE
-9T	30-MAR-1989	04:26	00d 00h 01m	<1%
-8T	2-APR-1989	03:07	00d 00h 01m	<1%
-7T	2-APR-1989	03:08	00d 00h 01m	<1%
-6T	2-APR-1989	03:09	00d 00h 01m	<1%
-5T	2-APR-1989	03:09	00d 00h 01m	<1%
-4T	2-APR-1989	03:10	00d 00h 01m	<1%
-3T	2-APR-1989	03:10	00d 00h 02m	<1%
-2T	2-APR-1989	04:39	00d 00h 03m	<1%
-1T	2-APR-1989	04:42	00d 00h 01m	<1%
DEMO	4-APR-1989	04:49	00d 01h 47m	5%
TOTAL USED				00d 01h 59m 6%
FREE				01d 08h 09m 94%

STATUS:

GRAPH RESULTS	TEXT RESULTS	DELETE STORE	DELETE ALL
---------------	--------------	--------------	------------

You may print the result as a numeric list or as graphs.

To Print Stored Results as a Numeric List

Select **TEXT RESULTS**.

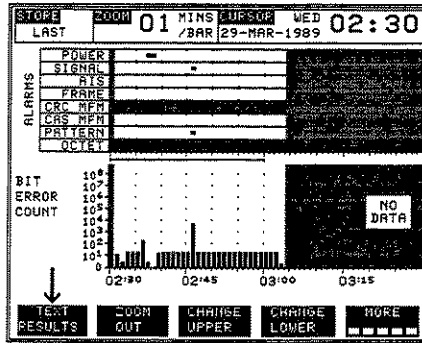

Select **PRINT**.

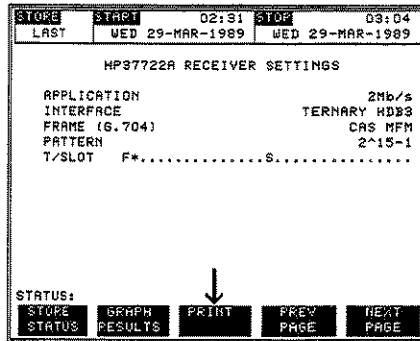

To Print Stored Results as Graphs of Alarms and Error Counts

Select **GRAPH RESULT**.

STORE	START DATE	START TIME	TEST DURATION	STORE USE
-9T	30-MAR-1989	04:25	00d 00h 01m	<1%
-8T	2-APR-1989	03:07	00d 00h 01m	<1%
-7T	2-APR-1989	03:08	00d 00h 01m	<1%
-6T	2-APR-1989	03:09	00d 00h 01m	<1%
-5T	2-APR-1989	03:09	00d 00h 01m	<1%
-4T	2-APR-1989	03:10	00d 00h 01m	<1%
-3T	2-APR-1989	03:10	00d 00h 02m	<1%
-2T	2-APR-1989	04:39	00d 00h 03m	<1%
-1T	2-APR-1989	04:42	00d 00h 01m	<1%
DEMO	4-APR-1989	04:49	00d 01h 47m	5%
TOTAL USED			00d 01h 59m	6%
FREE			01d 08h 09m	94%

↓

GRAPH RESULTS	TEXT Results	DELETE STORE	DELETE ALL
---------------	--------------	--------------	------------

Display the graphs to be printed by using **CHANGE UPPER** and **CHANGE LOWER**.

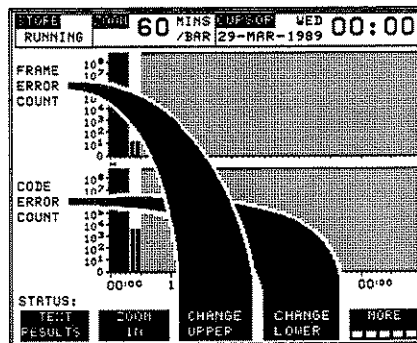

Move the cursor (between the graphs) to the time period you want using **↓** and **↑**.

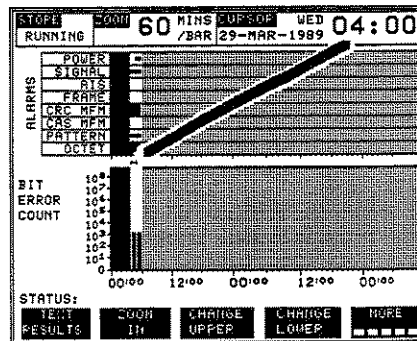

Select the resolution you want with
ZOOM IN / ZOOM OUT.

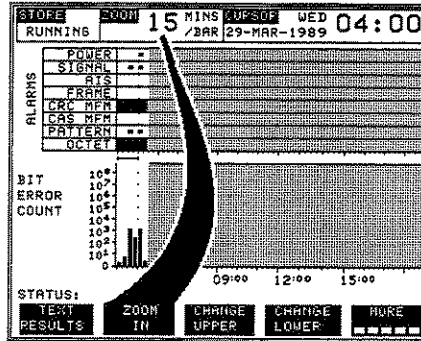

Select **PRINT**.

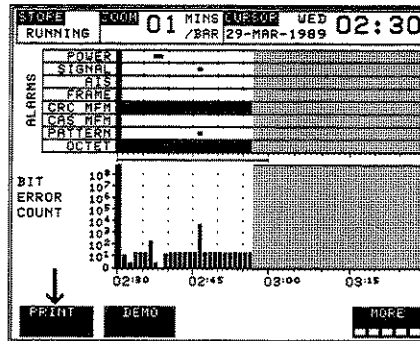

Select a print of the displayed screen
THIS SCREEN or set the cursor to where
you want the print to start and print the
remainder of the graph with
CURSOR TO END.

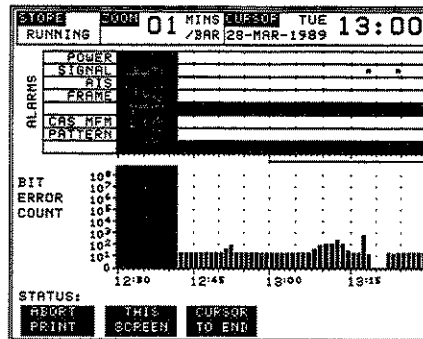

5-12 Printing Results

General Information

Introduction

This manual contains information which allows the user to operate and calibrate the HP 37722A Digital Telecom Analyzer. The Telecom Analyzer may be part of the HP 37732A Telecom/Datacom Analyzer.

Specification

Instrument specifications are listed on page 6-5. These specifications are the performance standards or limits against which the 37722A Telecom Analyzer or the telecom part of the HP Telecom/Datacom Analyzer are tested.

The specifications for the datacom accessory are contained in the separate Datacom Module manual.

Safety Considerations

This product is a Safety Class 1 instrument (provided with a protective earth terminal). The instrument and manual should be reviewed for safety markings and instructions before operation. Also read the Warning page at the front of this manual.

Options Available

The options which may have been ordered with the HP 37722A Telecom Analyzer are as follows:

- Option 002 Unframed pattern generation and measurements at 8 Mbit/s.
- Option 003 Framed/unframed pattern generation and measurements at 704 kbit/s.
- Option 004 Replaces four BNC connectors on the unbalanced ports with small Siemens connectors.
- Option 005 Sub rate testing, timeslot access, tone generation and measurement. X.58-PTT-NL (X.58-ESTI) Testing
- Option 006 Timeslot access, tone generation and measurement.
- Option 010 Relative frequency measurement.
- Option 210 M.2110 and M.2120 testing, Measurement timed start and Print at timed intervals.
- Option 908 Rack mount kit.
- Option B12 Battery Power Source (rechargeable).
- Option B48 External battery operation.
- Option H02 HP-IB remote control instead of RS-232.
- Option H08 Suppression of bit error recording during Pattern sync loss.
- Option V01 Virtual remote operation (needs HP 15800A virtual remote software).

To check which options are fitted - Press **OTHER** and select **OPTIONS**.

6-2 General Information

Accessories Supplied

The accessories that are supplied with the HP 37722A Telecom Analyzer are as follows:

<i>Accessories Supplied</i>	<i>Part Number</i>
Power Cord	See Installation Chapter
Operating and Calibration Manual	See Title Page
Front panel cover	HP 37701-00002

Accessories Available

The following accessories are available and may have been ordered with the Telecom/Datacom Analyzer:

HP 15510A	Protective monitor probe with BNC connectors for 75 Ω unbalanced systems.
HP 15511A	Protective monitor probe with 3-pin Siemens connectors for 120 Ω balanced systems.
HP 15512A	1 m (3 ft) test cable with two 3-pin Siemens male connectors.
HP 15525A	1.3 m (4 ft) coaxial test cable with two BNC unbalanced 75 Ω connectors.
HP 15525A Opt 003	1.3 m (4 ft) coaxial test cable with two small Siemens unbalanced 75 Ω connectors.
HP 15713A	19-inch rack mount kit - not suitable for instruments fitted with Battery Option B12.
HP 15716A	19-inch rack mount kit - suitable for instruments fitted with Battery Option B12.
HP 92204S	25-way V.24 Cable, 25-pin female D-type - 25-pin male D-type, length 1.2 m (4 feet).
HP 15692A	37-way V.11 Cable, 37-pin male - 37-pin male, length 3 m (10 feet).

HP 15746A	25-way RS-232 cable, 25 pin male D-type for connection to a HP 15730A/33A thermal printer.
HP 15708A	V.35 Cable, with male connectors at each end, length 3 m (10 feet).
HP 15710A	Carrying Case.
HP 2225D	Printer, ThinkJet RS-232.
HP 15730A	230 V, Printer, Thermal RS-232
HP 15733A	110 V, Printer, Thermal RS-232
HP 15714A	Cable, Telecom/Datacom Analyzer - HP 2225D Printer.
HP 5060-4462	RS-232 Test plug (for connector on side panel).

The following accessories are available and may have been ordered with the HP 15901A Option 001 Datacom Module:

HP 15712A	19-inch rack mount kit - used in conjunction with rack mount kits for the HP 37722A.
HP 92204S	25-way V.24 Cable, 25-pin female D-type - 25-pin male D-type, length 1.2 m (4 feet).
HP 15692A	37-way V.11 Cable, 37-pin male - 37-pin male, length 3 m (10 feet).
HP 15708A	V.35 Cable, with male connectors at each end, length 3 m (10 feet).

Specification

This section contains the specification for the HP 37722A Telecom Analyzer (or the telecom part of the HP 37732A Telecom/Datacom Analyzer). The datacom specifications for the HP 37732A are contained in the HP 15901A OPT 001 / HP 37732A Datacom Analyzer manual.

Except where otherwise stated the following parameters are *typical* or *nominal*. They provide a useful indication of the typical, but non-warranted, performance characteristics.

6-4 General Information

Specification

Facilities

Measurement and Analysis Interfaces: 2 Mbit/s with and without framing, 64 kbit/s G.703 co-directional interface. These interfaces can be mixed in any combination for Tx and Rx:

- 2 Mbit/s - 2 Mbit/s
- 64 kbit/s - 64 kbit/s
- 2 Mbit/s - 64 kbit/s
- 64 kbit/s - 2 Mbit/s

Alarm LEDs: AIS, Signal Loss, Frame Loss, CAS Multiframe Loss, CRC4 Multiframe Loss, Errors, Pattern Sync Loss, Remote Alarm, Remote Multiframe Alarm, Octet Loss .

Status LEDs: Signal Present

2 Mbit/s Framing to G.704,G.706 and G.732 standards:

- G.704 with no multiframe
- G.704 with CAS multiframe
- G.704 with CRC4 multiframe
- G.704 with CAS and CRC4 multiframe

CAS Multiframe: When selected, timeslot 16 frame 0 will contain the multiframe alignment signal. Timeslot 16 of frames 1 to 15 will contain user-defined 4 bit signaling codes which are all the same. If not selected, timeslot 16 is available as a data timeslot.

Test Patterns

PRBS Test Patterns

- CCITT Rec. 0.153: $2^{11}-1$
- CCITT Rec. 0.151: $2^{15}-1$, $2^{23}-1$ (except AMI)
- Inverted versions of these PRBS patterns for non-substrate applications.

Word Test Patterns: Fully programmable 16-bit word; all ones; 1 in 2. Fully programmable word 8 to 1024 bits in octet steps, octet aligned.

Auto setup: Bit rate, line code, framing and pattern are automatically determined when the Auto Setup button is pressed. For 2 Mbit/s framed, the pattern may be spread among multiple timeslots, so the timeslots are tested first, as set in the Settings page and then all timeslots. If no Pattern Sync is found the instrument proceeds in monitor mode.

Monitor Mode (Live Data) This is for use on live traffic where no known test pattern exists. No pattern synchronization is attempted and logic error results are invalid. Also, pattern slips are no longer valid. Monitor Mode can be selected by setting the pattern to "Live". It is automatically set on pressing Auto Setup if no recognizable pattern is found.

Transparent Loopback Mode: Loop timing is forced and the instrument retransmits the recovered Rx data. Frame and bit errors are all preserved. Internal drop and insert of any timeslot or all timeslots is possible in this mode. If data is inserted, then the outgoing CRC4 code must be regenerated and CRC4 errors will not pass transparently.

Transmitter Function: In measurement and analysis mode, the transmitter can be configured for pattern generation (for BER measurements) or for frame error simulation. Frame error simulation allows the framing algorithms and alarms of multiplexers to be tested. No simultaneous pattern generation is possible.

Receiver Function: In measurement and analysis mode, the receiver can be configured for error detection (for BER measurement) or timeslot display. The timeslot display mode allows the contents of selected timeslots to be examined. The signaling associated with any timeslot can be displayed in CAS multiframe mode. The framing and multiframing bits can also be displayed. No simultaneous error detection is possible but detection of valid alarms will take place. (Pattern Loss is not valid in any mode).

Test Period control

Manual: controlled by START/STOP key.

Single: user-defined duration.

Test Period is initiated by pressing the START/STOP key and normally terminates at the end of the period but this can be overridden by the START/STOP key.

Interval: 15 mins, 30 mins, 1 hr, 24 hrs, user program

6-6 General Information

User program: seconds from 1 - 100 seconds
minutes from 1 - 100 minutes
hours from 1 - 100 hours
days from 1 - 100 days

Indicator: Green LED above key is illuminated while a measurement is running.

TRANSMITTER

2 Mbit/s Transmitter

Interface characteristics meet CCITT Rec. G.703

Line Code: AMI, HDB3, NRZ

Ternary Data Output

Impedance: 120 Ω balanced or 75 Ω unbalanced (nominal)

Pulse Shape: Conforming to CCITT Rec. G.703 table 6

Jitter: typically meets CCITT Rec. G.823 Section 2

Binary Data Output

Impedance: 75 Ω unbalanced (nominal)

Format: NRZ Binary

Amplitude: Mark > 3.0 Volts

Space < 0.5 Volts

Binary Clock Output

Impedance: 75 Ω unbalanced (nominal)

Format: Square wave, 50 \pm 6 % duty cycle on internal clock

Amplitude: Mark > 3.0 Volts

Space < 0.5 Volts.

Polarity: Normal or Inverted

Tx Clock Source: The Tx can be clocked from the internal clock, a clock recovered from the receiver clock (loop timing) or from an external clock source.

Internal Tx Clock: Frequency: 2.048 MHz
Stability: ± 10 ppm temperature 0 - 50 C
Ageing : ± 2 ppm per year (typical)

External Tx Clock: Frequency: 2.048 MHz ± 200 ppm.
Impedance, Format and Threshold: as for 2 Mbit/s receiver binary clock input.

Looped Timing

Indication: Tx clock loss will be flagged if no clock can be recovered from the received signal.

Spare International (Si) Bits: In framing mode the Si bits can be set to all ones or all zeros, with default all ones. When the CRC4 multiframe is selected the Si bits in frames 13 and 15 can be set independently. These bits signal that block errors have been detected to the far end, default condition is both one.

FAS Word

Bit 1	Bit 2	Bit 3	Bit 4	Bit 5	Bit 6	Bit 7	Bit 8
Si	0	0	1	1	0	1	1

NFAS Word

Bit 1	Bit 2	Bit 3	Bit 4	Bit 5	Bit 6	Bit 7	Bit 8
Si	1	A	Sa	Sa	Sa	Sa	Sa

Spare Application (Sa) Bits: In framing mode there are 5 Sa bits (bits 4 to 8 of timeslot zero of NFAS frames). These can be set to any 5-bit pattern, default all ones.

Spare MFAS Timeslot Bits: In framing mode with CAS multiframe enabled, there are 3 spare bits in timeslot 16 of frame zero (bits 5, 7 and 8). These can be set to any 3-bit pattern, default all ones.

NFAS Bits Transmit: Bits 4 to 8 of odd-numbered frames within the 2 Mbit/s CRC4 multiframe structure can be set independently to a one or zero.

Signaling Bits: In G.704 with CAS multiframe, the ABCD signaling bits can be set to any 4-bit pattern. All channels are set to the same pattern, default 0101.

6-8 General Information

Alarm Generation

AIS with 2 zeros in 512 bits (true AIS)

AIS with 3 zeros in 512 bits (false AIS)

AIS all ones

Remote alarm (bit 3 of NFAS timeslot set to 1)

Remote multiframe alarm (bit 6 of MFAS timeslot set to 1)

No signal

Transmitter Timeslot Selection: For Measurement and analysis mode when the transmitter is configured for 2 Mbit/s, the timeslots can be selected as: All timeslots; Single timeslot; n timeslots for n up to 31. For "all timeslots", the pattern is loaded into all data timeslots. Timeslot 0 is always reserved for framing. Timeslot 16 is reserved for signaling in CAS multiframe mode. For "single timeslot" or "n timeslots", any timeslot can be selected except timeslot zero and timeslot 16 in CAS multiframe mode.

Deselected timeslots: Loaded with either all ones, or a repeating 2^6-1 PRBS (to simulate live traffic).

Tx Error Add

Bit errors: These are errors inserted into the test pattern. They will not cause any code, frame or CRC errors.

Code errors: Violations of the AMI coding rule. These will not directly cause any bit, frame, or CRC errors but some error extension is possible with HDB3 coding.

Error Add Rate: Errors can either be added singly or at preset rates of 10^N where $N = 2$ to 8.

Frame Error Simulation Mode: Special sequences of errors can be generated in any framing timeslot. Timeslot selection for frame simulation is: FAS word, NFAS bit, CAS MFAS word (CAS multiframe mode), CRC MFAS word (CRC4 multiframe mode), CRC bits (CRC4 multiframe mode).

Mode: Burst, Continuous

FAS Error Simulation: This is used for testing the alarm thresholds of most multiplexers.

Burst: 1 error; 2 errors; 3 errors; 4 errors; 5 errors

Continuous: No errors; 5 in 10^6 ; 2 in 10^5 ; 5 in 10^4 ; 2 in 10^3 ; 2 in 4 (sync); 1 in 2 (hold); 3 in 4 (sync loss).

NFAS Error Simulation:

Burst: 1 error; 2 errors; 3 errors; 4 errors; 5 errors

Continuous: No errors; 1 errored NFAS word in 2 (hold sync if in sync); 3 errored NFAS words in 4 (sync loss); All errored

CAS MFAS Error Simulation:

Burst: 1 error; 2 errors; 3 errors; 4 errors; 5 errors

Continuous: No errors; 1 errored MFAS word in 2 (multiframe sync gain); All errored (multiframe sync loss).

CRC MFAS Error Simulation:

Continuous: No errors; 2 errored CRC MFAS words in 4 (CRC multiframe sync gain); 3 errored CRC MFAS words in 4 (CRC multiframe sync loss); Lose Frame Sync.

CRC Error Simulation:

Burst and Continuous: N in 1000 where N = 1 to 1000

64 kbit/s Transmitter

Interface: G.703 co-directional

Data Output

Impedance: 120 Ω balanced (nominal)

Pulse Shape: Conforming to CCITT Rec. G.703 Table 1

Tx Clock Source: The Tx can be clocked from the Internal clock, a clock recovered from receiver clock (loop timing) or from an external clock source.

Internal Tx Clock

Frequency: 64 kHz.

Stability: ± 10 ppm temperature 0 - 50 C.

Ageing: ± 2 ppm per year typical

External Tx Clock

Frequency: 256 kbit/s ± 200 ppm.

Impedance, Format and Threshold: As for 2 Mbit/s receiver binary clock input.

Looped Timing

Indication: Tx clock loss will be flagged if no clock can be recovered from the received signal.

Octet Timing: Octet timing (as described in CCITT Rec. G.703) can be disabled if required when codirectional data has been selected.

Error Addition: Bit errors can be added singly or at a preset rate of 1 in 10^N where $N = 2$ to 8.

RECEIVERS

2 Mbit/s Receiver

Interface characteristics meet CCITT Rec. G.703

Ternary Data Input

Rate: 2.048 Mbit/s ± 100 ppm (G.703 specs ± 50 ppm)

Pulse shape: Will accept any pulse shape conforming to CCITT Rec. G.703 Table 6 with between 0 and 6 dB of "root f" loss at 1.024 MHz. In addition, automatic gain control will compensate for flat loss of up to 30dB (for protected monitor points or use with a bridging probe).

Input Impedance: 120 Ω balanced or 75 Ω unbalanced (nominal)

Interference: Typically meets CCITT Rec. G.703

Jitter Tolerance: The input typically tolerates a signal modulated by a sinusoidal jitter having an amplitude/frequency relationship defined in CCITT Rec. G.823 Section 3.

Binary Data Input

Impedance: 75 Ω unbalanced (nominal)

Format: NRZ Binary

Rate: 2.048 Mbit/s (nominal)

Threshold: 1.4 Volts (nominal)

Binary Clock Input

Impedance: 75 Ω unbalanced (nominal)

Format: Square wave

Frequency: 2.048 MHz (nominal)

Threshold: 1.4 Volts (nominal)

Polarity: Normal or Inverted

Alarm Criteria

Alarm Hierarchy

A hierarchy of status alarms is implemented in the HP 37722A. This will affect those alarms currently in context for the current settings of the instrument.

The hierarchy is such that the more important alarm will suppress a lesser alarm if the more important alarm is true. FRAME LOSS, PATTERN LOSS and REMOTE ALARM also include their sub 64 kbit/s counterparts.

Graphically:

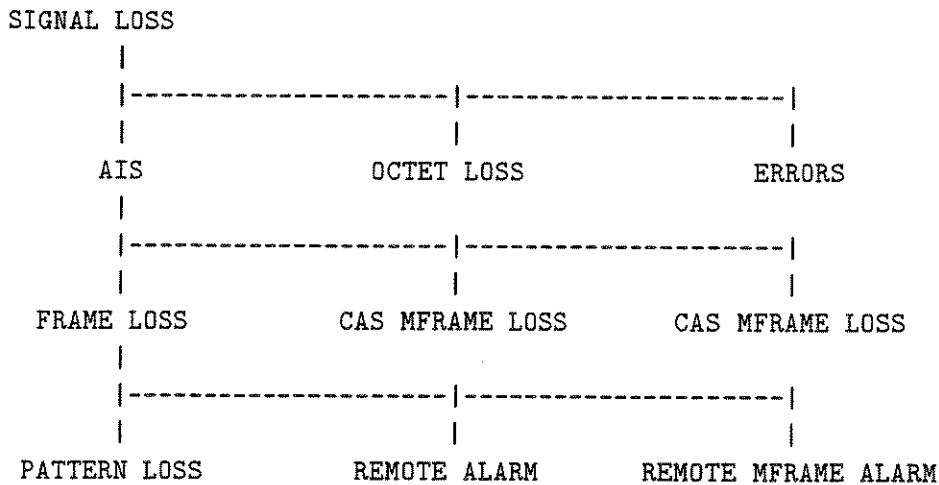

- SIGNAL LOSS should suppress all alarms below it.
- AIS should suppress all alarms below it.
- FRAME should suppress all alarms below it. (It will not suppress CASMFM or CRCMFM).

AIS: Less than 3 zeros in 512 bits.

Signal Loss

HDB3: 11 or more consecutive zeros. Alarm clears on receipt of a one.

AMI: 16 or more consecutive zeros. Alarm clears on receipt of a one.

6-12 General Information

NRZ: No receive clock transitions in the last 100MS. Alarm clears on receipt of a clock transition.

Frame Loss: 3 or more consecutive FAS words in error, or 3 or more consecutive NFAS bits in error. Frame sync is regained when 2 or more consecutive good FAS words are received with no NFAS errors.

CAS Mframe Loss: 2 consecutive MFAS words in error or all zeros in timeslot 16. Multiframe sync is regained on the first occurrence of a good MFAS.

CRC4 Mframe Loss: CRC4 sync will not be achieved until at least 2 good CRC4 MFAS words are detected within 8 ms of achieving frame sync. This is protection against false frame emulators.

Remote Alarm: Bit 3 of all NFAS words set to 1.

Remote Mframe Alarm: Bit 6 of timeslot 16 frame zero set to 1.

Receiver Timeslot Selection: For Measurement and analysis mode when the receiver is configured for 2 Mbit/s, the timeslots can be selected as follows: As per transmitter; All timeslots; Single timeslot; n timeslots, for n up to 31.

For “all timeslots”, the pattern is extracted from all data timeslots. Timeslot 0 is always reserved for framing. Timeslot 16 is reserved for signaling in CAS multiframe mode. For “single timeslot” or “n timeslots”, any timeslot can be selected except timeslot zero and timeslot 16 in CAS multiframe mode.

Pattern sync

Sync Loss: This occurs when the error ratio exceeds 10% for PRBS and 4% for word, over 100 ms.

Sync Gain: Sync is regained after 32 error-free clock periods.

Resync: Resync is automatically attempted upon sync loss.

Measurements: Frequency count, frequency offset, bit error count, code error count (excluding HDB3 substitutions), frame bit error count, CRC4 error count, REBE (remote end block error) count, round trip delay (PRBS trigger method)

Timeslot Monitor: The following are displayed: Single data timeslot; Frame alignment signal timeslot; Not frame alignment signal timeslot; Frame zero timeslot 16; Single signaling channel; all signaling channels.

NFAS Receiver Timeslot Display: For 2 Mb/s receiver with CRC framing, timeslot monitor will offer a display of NFAS bits for all odd numbered frames.

The main display will be in real time with a capture period of 45ms such that events within any one timeslot will be seen if the event duration is 45ms or greater. An event being a 0-1-0 or 1-0-1 transition. Adjacent to the main display will be an event capture display.

Two methods of event capture are offered:

(i) Event Monostable.

In addition to the real time display a display offering state change indicators is offered. These indicators will hold an event for 1s after the event has gone. In the case of bit-8 (most significant bit) the indicator will hold for 1-minute after the event has gone.

or

(ii) Event Latch.

In addition to the real time display a display offering state change indicators is offered. These indicators will hold an event after the event has gone. Adjacent to these indicators a date/timestamp will mark when the first event in a timeslot occurred. The event to be timestamped is programmable across all timeslots. The event capture and timestamp are cleared by use of the "RESET HISTORY" key on the front panel.

Slip detection

Controlled slips can be detected in a timeslot when loaded with a PRBS pattern. Changes of frame alignment (COFAs) are detected and counted.

64 kbit/s Receiver

Codirectional Data Input

Rate: 64 kbit/s ± 150 ppm (G.703 specs ± 100 ppm)

Pulse shape: Will accept any pulse shape conforming to CCITT G.703, figure 5 with between 0 and 3dB of "root f" loss at 128 kHz. In addition, automatic gain control will compensate for flat loss of up to 25dB (for protected monitor points or use with a bridging probe).

Input Impedance: 120 Ω balanced (nominal).

Interference: Typically meets G.703

Jitter Tolerance: The input typically tolerates a signal modulated by a

6-14 General Information

sinusoidal jitter having an amplitude/frequency relationship defined in CCITT Rec. G.823 Section 3.

Alarm Criteria

Alarm Hierarchy: As for 2 Mbit/s for appropriate alarms.

AIS: Less than 5 zeros in 128 bits.

Signal Loss: Codirectional: No data transitions in 5 ms. Alarm, clears on receipt of a data transition.

NRZ: No receive clock transitions in the last 5 MS. Alarm clears on receipt of a clock transition.

Octet Loss

Codirectional: No octet timing violations for 8 consecutive octets. Clears on receipt of first octet violation.

Pattern sync: As for 2 Mbit/s Rx.

Measurements: Frequency count, bit error count

Telecom Measurements

Results

Display Update: Count displays update every 100ms to show the cumulative result. Ratio and percentage displays update every second to show the cumulative result. After a single test period the final result is held until a new test period is initiated, even if the instrument configuration is modified.

Error Results

Validity: Error count, error free seconds, average error ratio and current error ratio valid for bit, code frame CRC4 and REBE errors. Bit and frame errors are valid for sub 64 kbit/s results.

Error Count: Errors are counted for all sources over total elapsed time. Counting may be inhibited under certain alarm conditions, see Effects of Alarms on Basic Errors below.

EC Format: 6 digit display for < 1,000,000 errors. X.YYY x 10ⁿ, where n = 6 to 12, for >= 1,000,000 errors. For CRC error counts, an incorrect CRC checksum is counted as one error.

Error Free Seconds: Error free seconds are counted for all sources over total elapsed time. Counting may be inhibited under certain alarm conditions, see

Effects of Alarms on Basic Errors below.

Error Free Seconds Format: 9 digit display

% Error Free Seconds: The number of error free seconds during a test period expressed as a percentage of the elapsed seconds.

Cur. Error Ratio: Current error ratio, measured over the last second.

Cur. ER Format: X.YYY x 10⁻ⁿ, where n = 1 to 7.

Ave. Error Ratio: Average Error Ratio, measured over total elapsed time.

Ave. ER Format: X.YYY x 10⁻ⁿ, where n = 1 to 12. For CRC and REBE error ratio results the number of clocks is used as the base.

Pattern Loss Events: A count of pattern loss events is available in all modes.

Effects of Alarms on Basic Errors

The instrument will disable (*) the counting of errors in the presence of various alarms which are in context for the current settings of the instrument. These alarms will affect the error count (EC) and the error free seconds (EFS) results.

Unframed 2 Mbit/s, 704 kbit/s, 8 Mbit/s, 64 kbit/s.

EC/EFS Result	SIGNAL LOSS	AIS	PATTERN LOSS	SUB FRAME LOSS
Bit	*			*
Code	*			

Framed 2 Mbit/s, 704 kbit/s (non-CRC4 framing).

EC/EFS Result	SIGNAL LOSS	AIS	FRAME LOSS	CASMFM LOSS	PATTERN LOSS	SUB FRAME LOSS
Bit	*	*	*			*
Code	*					
Frame	*	*	*			*

Framed 2 Mbit/s (CRC4 framing).

EC/EFS Result	SIGNAL LOSS	AIS	FRAME LOSS	CRCMFM LOSS	PATTERN LOSS	SUB FRAME LOSS
Bit	*	*	*			*
Code	*					
Frame	*	*	*			*
CRC	*	*	*	*		
REBE	*	*	*	*		

N.B. For CRC-CAS framing see 2 Mbit/s CAS for CASMFM alarm effect.
 *' = Sub 64 kbit/s sub frame results.

G.821 Error Analysis

Validity: G.821 Error analysis can be done in full on Bit, Frame, CRC and REBE errors. The results are: Unavailable seconds, % unavailability, Error seconds, % error seconds, severely errored seconds, %severely errored seconds, degraded minutes, % degraded minutes and long term mean error ratio.

Valid in all test periods. Counting may be inhibited under certain alarm conditions, see Effects of Alarms on Analysis below.

G.821 applies to 64 kbit/s stream only. A normalized estimate can be selected for %ES, %DM and %SES for the higher bit rates as in CCITT Rec. G.821 Annex D. Once selected it will be stated on the G.821 analysis result page. User-defined G.821 standard and Annex D are also available.

Display Format: Count results 9 digit display (ES, SES etc) Percentage results are shown as XX.YYYYYY% or 100.00000%. LTMER result X.YYY x 10⁻ⁿ, where n = 1 to 12.

SES: The number of severely errored seconds (SES) is counted over the available time. A severely-errored second is a second which has an error ratio worse than a user defined threshold (10^{-N} where N = 2 to 5) The default is 10⁻³. For CRC and REBE errors the severely errored second threshold can be set to N in 1000 where N is between 1 and 1000. The default is 871 which corresponds to a random error rate of 10⁻³. Some alarm seconds are treated as SES's, see Effects of Alarms on Basic Errors below.

% SES: The number of severely errored seconds (SES) expressed as a percentage of the available time in seconds.

Unavailability: The number of unavailable seconds during a test period. A system becomes "available" when the error ratio measured in 1 second intervals is better than the severely errored second threshold for 10 or more consecutive seconds. A system becomes "unavailable" when the error ratio measured in 1 second intervals is greater than the severely errored second threshold for 10 or more consecutive seconds.

% Unavailability: The number of unavailable seconds during a test period expressed as a percentage of the number of elapsed seconds.

ES: Asynchronous error seconds (ES) are counted over available time.

% ES: Asynchronous error seconds counted over available time expressed as a percentage of the available time in seconds.

DM: The number of degraded minutes (DM) during the test period. A degraded minute is a 60 second (1 minute) composite interval during available time (excluding severely errored seconds) over which the error ratio is worse than the selected threshold.

% DM: The number of degraded minutes expressed as a percentage of the total number of elapsed minutes of available time.

LTMER: Long Term Mean Error Ratio, is calculated for available time excluding the effects of any errors occurring in Severely Errored Seconds.

Effects of Alarms on Analysis

The instrument will treat the occurrence of certain alarm seconds as a G.821 severely errored second (SES) and a G.821 error second (ES). These alarms are those which are in context for the current settings of the instrument. The effect will be to increment (*) the ES and SES count and hence affect other relevant G.821 analysis results.

Unframed 2 Mbit/s, 704 kbit/s, 8 Mbit/s, 64 kbit/s

G.821 ES/SES	SIGNAL LOSS	AIS	PATTERN LOSS	SUB FRAME LOSS
Bit	*	*	*	*

Framed 2 Mbit/s, 704 kbit/s (non-CRC4 framing).

G.821 ES/SES	SIGNAL LOSS	AIS	FRAME LOSS	CASMF M LOSS	PATTERN LOSS	SUB FRAME LOSS
Bit	*	*	*		*	*
Frame	*	*	*			

Framed 2 Mbit/s (CRC4 framing).

G.821 ES/SES	SIGNAL LOSS	AIS	FRAME LOSS	CRCMF M LOSS	PATTERN LOSS	SUB FRAME LOSS
Bit	*	*	*		*	*
Frame	*	*	*			
CRC	*	*	*	*		
REBE	*	*	*	*		

N.B. For CRC-CAS framing see 2 Mbit/s CAS for CASMF M alarm effect.

Alarm Seconds

Display Format: 9 digit display

Alarms Analyzed: Power Loss, AIS, Signal loss, Frame Loss, CAS Multiframe Loss, CRC4 Multiframe Loss, Remote Alarm, Remote Multiframe Alarm, Pattern Sync Loss

Frequency Results

Display Format: XXXXXXX Hz

Resolution: 1 Hz

Accuracy: ± 10 ppm ± 1 count

Ageing: ± 2 ppm per year (typical)

Frequency Offset

Display Format: $\pm XXX$ ppm

Range: -199 ppm to +199 ppm

Resolution: 1 ppm

Accuracy: ± 10 ppm

Ageing: ± 2 ppm per year (typical)

COFAs: Changes of Frame Alignment or uncontrolled slips (COFAs) are detected and counted in available time. COFAs are available for 2Mb/s framed Rx signals except Tones. Bit errors are suppressed over a period from 200ms before the slip until the slip is resolved. The frame loss associated with a COFA suppresses CRC, Frame and REBE errors.

Pattern Slips: Count of number of controlled octet slips (positive or negative) in available time. Frame slips are available for 2Mb/s, 704kb/s and 64kb/s RX with PRBS pattern. Bit errors are suppressed over a period from 200ms before the slip until the slip is resolved.

Round Trip Delay Result

Display Format: XXXX ms, low resolution. XX.XXX ms, high resolution.

Range: 0.000 ms to 1023 ms.

Resolution: 1 ms, low resolution. 1 μ s, high resolution.

Threshold 50 ms, with ± 1 ms hysteresis.

Accuracy: low resolution, 3% ± 1 ms nominal.

high resolution, 3% ± 0.001 ms nominal.

Validity: Only valid for 2 Mb/s with ternary interface, HDB3 linecode and 2^{23} PRBS pattern.

Trouble Scan

A convenient display is provided showing a summarised error count and alarm status for all relevant error sources for the current or previous test. Error counts will not be displayed if all relevant error sources and alarms are clear.

Instead a message will be displayed.

Validity: Valid for all test periods. see also "The Effects of Alarms on Basic Errors" and "Alarm Hierarchy".

Error Count: Errors are counted for all sources over total elapsed time.

Error Count Format: 6 digit display.

Time Functions

Real Time Clock

Fundamental Period: 100 ms (nominal)

6-20 General Information

Stability: Crystal controlled $\pm 0.01\%$

Display: Displays of time and date are presented on the TIME & DATE, OTHER page.

Time format is: Time hours:minutes:seconds

Date format is: Day-month-last two digits of year

Both can be set at any time. (Time display resolution 1 second).

Elapsed Time: The instrument can monitor the time which has elapsed since the start of a test period. This facility is available in all Test Periods.

M.2100

Interface 2.048kbit/s framed.

Pattern loss

A selection of pattern loss criterion for *0.151 (CCITT)* compatibility is available:- ie pattern loss occurs on 10 consecutive deci-seconds, each with BER $\geq 20\%$ (PRBS), or 4% (WORD). The *standard* criterion is ANY deci-second with BER $\geq 20\%$ (PRBS), or 4% (WORD).

Interface

M.2100 measurements are only available when the HP 37732 is measuring a 2.048Mbit/s signal.

Evaluation of M.2100 ES and SES

M.2100 ANOMALY: a second containing 1 or more errors from 1 or more sources; eg CRC, FAS.

M.2100 DEFECT: a second where the service is degraded beyond a reasonable limit; eg a second containing an alarm, or a BER $> 1E-3$.

M.2100 AVAILABILITY ES and SES are not counted during unavailable time. The system goes unavailable at the onset of 10 consecutive SES. The system goes available at the onset of 10 consecutive non-SES.

To separately process the TX and RX paths, together with separate processing of in-service and out-of-service requires 9 counts; ES, SES and UAS for counts of RX in-service, RX out-of-service and TX in-service measurements. The individual sources are shown in the following table:

Note: Frame error, CRC, REBE SES thresholds are user definable.

IN-SERVICE					
non-CRC4 framing.					
	LOF	LOS	FAS	Frame bits	A-bits
RX-ES	≥ 1	≥ 1	≥ 1	(≥ 28)	
TX-ES					$\geq d$
RX-SES	≥ 1	≥ 1		≥ 28	
TX-SES					$\geq d$
CRC4 framing.					
	LOF	LOS	FAS	Frame bits	A-bits
RX-ES	≥ 1	≥ 1	≥ 1		
RX-SES	≥ 1	≥ 1	≥ 805		
TX-ES				≥ 1	
TX-SES				≥ 805	$\geq e$
OUT-OF-SERVICE					
non-CRC4 framing.					
	LOF	LOS	FAS	Frame bits	logic
RX-ES	≥ 1	≥ 1	≥ 1	(≥ 28)	≥ 1
RX-SES	≥ 1	≥ 1		(≥ 28)	$\geq 1e-3$
CRC4 framing.					
	LOF	LOS	FAS	Frame bits	logic
RX-ES	≥ 1	≥ 1	≥ 1		≥ 1
RX-SES	≥ 1	≥ 1	≥ 805		$\geq 1e-3$

Additionally a pattern slip causes a RX-OOS-SES.

6-22 General Information

SES Thresholds

Type	Range	Default
Frame Error	1 to 99	28
CRC	1 to 999	305
REBE	1 to 999	305

A-bit threshold

“d & e”: Two consecutive 5ms periods each containing ≥ 1 “A” bit.

Graphs and internal logging

Graphical storage of COFAs and Pattern slips are provided. Graphical storage of M.2100 results are provided. The additional event tracks are:

1	COFA	RX	(In- & Out-of-service)
2	Pattern-slip	RX	(Out-of-service)
3	ES	RX	In-service
4		TX	In-service
5		RX	Out-of-service
6	SES	RX	In-service
7		TX	In-service
8		RX	Out-of-service
9	UAS	RX	In-service
10		TX	In-service
11		RX	Out-of-service

General Specifications

Graphics

Histogram: Display or print out versus time of two error sources.

Error Sources: Bit error count, Frame alignment signal error count, Code error count (excluding HDB3 substitutions), CRC4 error count, REBE (Remote End Block Error) count, Alarms. The validity of error sources depends on instrument setup. If not valid that error source will not be displayed.

Alarms: Power Loss, Signal Loss, AIS, Frame Loss, CAS Multiframe Loss, CRC4 Multiframe Loss, Pattern Loss, Octet loss.

Error count scale: Pseudo logarithmic range of more than 8 decades, each decade being represented linearly.

Storage

Storage: For up to 10 tests with a maximum of approximately 5000 event capacity. Once the remaining store capacity has been used, previous test data will be overwritten. There is no lock mechanism to retain old stored data.

Storage resolution: 1 min (32 hours of storage), 15 min (480 hours of storage), 1 hour (80 days of storage)

Stored Measurements: End of Period Results: Error Count, Average Error Ratio, Error Free Seconds, Unavailability, % Unavailability, Error Seconds, % Error Seconds, Severely Errored Seconds, % Severely Errored Seconds, Degraded Minutes, % Degraded Minutes, Long Term Mean Error Ratio.

Validity: Valid for all test periods. Validity as for basic errors and analysis.

Format: Same as Error Results and G.821 Error Analysis.

Alarm Seconds

Alarms Stored: Power Loss, AIS, Signal Loss, Frame Loss, CRC4 Multiframe Loss, CAS Multiframe Loss, Pattern Loss, Octet loss, Remote alarm and Remote multiframe alarm.

Stored Setups

Receiver Settings: Application, Interface and Linecode, Frame, Pattern and Timeslot(s).

6-24 General Information

Printer Output

Printer output is conditional upon whether the instrument is currently running a test or not.

By pressing the 'PRINT NOW' hardkey outside of testing , the instrument will print a summary of current instrument settings followed by a summary of the results from the last test period.

By pressing the 'PRINT NOW' hardkey during testing , the instrument will print a summary of current instrument settings followed by a snapshot of the results from the current test period.

Graphical printer output is only available outside of testing and is conditional upon which graphics page is currently displayed.

By pressing the 'PRINT' softkey offered on the graphics 'TEXT RESULTS' page, a summary of instrument settings followed by stored textual results are printed for the graphics store currently selected.

By pressing the 'PRINT' softkey offered on the graphics 'GRAPH RESULTS' page, a summary of instrument settings followed by two (currently displayed) error count histograms plus alarms are printed for the graphics store currently selected.

A facility is provided to print from the cursor to the end of the graph.

Printer and remote control port: Full duplex RS-232 serial interface configured as a DCE. Direct connection may be made to DTEs, such as printers and dumb terminals. An adaptor cable is required for connection to devices configured as DCE. Printer output and remote control mode are mutually exclusive.

Printer Output Mode Configuration

Baud rate: 300 600 1200 1800 2400 4800 9600

Data bits: 8

Parity: None

Stop bits: 1 or 2

Transmit pacing: Off, ENQ/ACK, Xon/Xoff, DTR

Print Style: Normal or Compress (80 columns on 40 column printer).

Remote Control

Remote Control Mode Configuration

Baud rate: 300 600 1200 1800 2400 4800 9600

Data bits: 7

Parity: Odd, Even, Zeros, Ones

Stop bits: 1 or 2

Pacing: ENQ/ACK (off, on), Xon/Xoff (Rx only, Tx only or Rx & Tx, off),

In addition to Xon/Xoff and ENQ/ACK character handshake flow control, the HP 37722A provides an optional COMMAND PROMPT to facilitate remote control via a dumb terminal. When this feature is in use, the HP 37722A echoes keystrokes/characters back to the terminal/controller and returns a prompt string to signify that it is ready to accept a new command.

RS-232 connector configuration

Pin	Mnemonic	Description
1	PGND	Connected to chassis ground
2	TXD	37722A data input
3	RXD	37722A data output
4	RTS	Internally connected to CTS in the 37722A
5	CTS	Internally connected to RTS in the 37722A
6	DSR	Set "ON" by 37722A when powered
7	SGND	Signal ground
8	DCD	Set "ON" by 37722A when powered
20	DTR	When DTR transmit pacing is selected, data output from the 37722A is inhibited if DTR is held "OFF" by receiving device.

Modem Operation: Remote control via a modem link requires a pair of full duplex modems. Connection between the HP 37722A and the modem should be by means of a cable configured as follows:

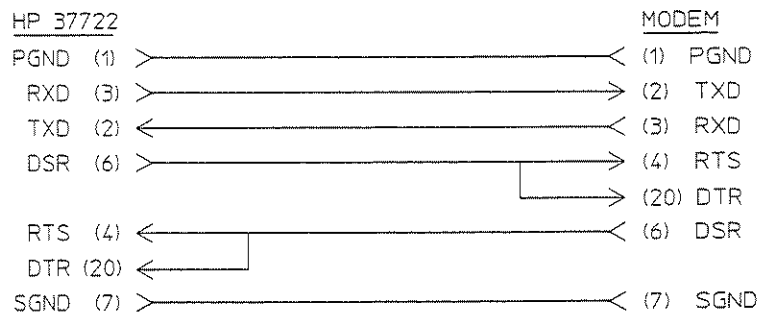

Serial Accessory Interface: The interface, via a 40-pin female connector, includes clock, data, control and power connections to the Datacom Module. High speed signals are balanced, conforming to V11. To reduce power consumption these lines are unterminated. Signal reflections are kept to the minimum by the short length of cable to the module.

The Reference Clock is a high accuracy signal timing both TX Data out of the instrument and RX data into it. Its frequency is at least twice the maximum frequency of any clock on the datacom interfaces. TX and RX Inhibit are used to suspend the flow of valid data between the instrument and the datacom module.

Control and some measurement information is passed between the datacom module and the instrument on a full-duplex serial link running at over 100 kbit/s. Serial Enable is an unbalanced signal used to address the datacom module's control processor. The Reset line is also unbalanced and permits the instrument to asynchronously reset the datacom module.

User Confidence Tests: These tests provide a high confidence level that the instrument operates to specification. They will also provide service information for fault location.

EMC Compliance: The HP 37722A has been tested and complies with FTZ 1046 when used with the following cables:

37722-60024 3-pin Siemens
15900-60001 V.24

Protection: No damage shall result to the test set if a short or open-circuit is applied to any input or output of the instrument.

Environmental

Power Supply

Size: 340mm (13.4in) wide, 190mm (7.5in) high, 208mm (8.2in) deep including front panel cover or datacom module.

Weight: HP 37722A 4.5 kg (10 lb),
HP 37732A 5.9 kg (12.5 lb).

Operating temperature: 0 to +50°C.

Storage Temperature: -40 to +70°C.

Input voltage: 95Vac to 240Vac $\pm 10\%$

Input frequency range: 47Hz to 66Hz

LpA < 70dB	LpA < 70 dB
operator position	am Arbeitsplatz
normal operation	Normaler Betrieb
per ISO 7779	nach DIN 45635 T. 19

Options

Option 002 - 8 Mbit/s Transmit/Receive

Line Code: HDB3

Ternary Data Output

Impedance: 75 Ω unbalanced (nominal).

Pulse Shape: Conforming to CCITT G. 703 table 7.

Jitter: typically less than the limits in CCITT G.823 section 2.

Binary Data Output

Impedance: 75 Ω unbalanced (nominal).

Format: NRZ Binary.

6-28 General Information

Amplitude: Mark > 3.0 Volts.
Space < 0.5 Volts.

Binary Clock Output

Impedance: 75 Ω unbalanced (nominal).

Format: Square wave, 50 \pm 6 % duty cycle on internal clock.

Amplitude: Mark > 3.0 Volts.
Space < 0.5 Volts.

Polarity: Normal or Inverted.

Tx Clock Source

The Tx can be clocked from the following sources:

- Internal clock
- External clock from the 'CLOCK IN' port.
- Recovered clock from receiver (loop timing)

Internal Tx Clock

Frequency: 2.048 MHz.

Stability: \pm 10 ppm temperature 0 - 50 C.

Ageing: \pm 2 ppm per year (typical).

External Tx Clock

Impedance: As 2Mb/s receiver binary clock input.

Format: As 2Mb/s receiver binary clock input.

Threshold: As 2Mb/s receiver binary clock input.

Frequency: 2.048Mbit/s \pm 200ppm.

Looped Timing

Indication: Tx clock loss will be flagged if no clock can be recovered from the received signal.

Framing

G.732 framing can be enabled or disabled.

Tx Error Add - Measurement and Analysis Mode

- Bit
- Code

Bit errors: errors inserted into the test pattern will not cause any code errors.

Code errors: violations of the HDB3 coding rule could cause bit errors.

Error Add Rate

Bit and code errors can either be added singly or at preset rates of 1 in 10^{-N} where N is any number from 2 to 8.

Frame Error Add Rate

Frame errors are inserted into the FAS word. The following choices are possible:

- Off - no errors in FAS word
- 1 in 4 FAS - sync gain
- 3 in 4 FAS - hold
- All errored - sync loss

Alarm Generation

The following alarm signals can be simulated:

- AIS all ones.
- Remote alarm (bit 11 of FAS word set to 1)
- No signal.

Ternary Data Input

Rate: 8.448 Mbit/s \pm 100 ppm. (G.703 specs \pm 30 ppm)

Pulse shape: Will accept any pulse shape conforming to table 7/G.703 with between 0 and 6dB of "root f" loss at 4.224 MHz. In addition, automatic gain control will compensate for flat loss of up to 30dB (for protected monitor points or use with a bridging probe).

Input Impedance: 75 Ω unbalanced (nominal)

Interference: typically meets G.703

Jitter Tolerance: The input typically tolerates a signal modulated by a

sinusoidal jitter having an amplitude/frequency relationship defined in CCITT G.823 section 3.

Binary Data Input

Impedance: 75 Ω unbalanced (nominal).

Format: NRZ Binary.

Rate: 8.448 Mbit/s (nominal).

Threshold: 1.4 Volts (nominal).

Binary Clock Input

Impedance: 75 Ω unbalanced (nominal).

Format: Square wave.

Frequency: 8.448 MHz (nominal).

Threshold: 1.4 Volts (nominal).

Polarity: Normal or Inverted.

Alarm Criteria

AIS: Less than 3 zeros in 512 bits.

Signal Loss: HDB3: 11 or more consecutive zeros. Alarm clears on receipt of a one.

Pattern sync

Sync Loss: Sync loss is deemed to have occurred if the error ratio exceeds 4% on 16 bit user word or 10% on a prbs as measured over a period of time. The time period is selectable between one 100 ms period, or 10 consecutive 100ms periods.

Sync Gain: Sync is regained after 32 error-free clock periods.

Resync: Resync is automatically attempted upon sync loss.

Measurements

- frequency count
- frequency offset
- bit error count
- code error count (excluding HDB3 substitutions)
- frame error count

Variable Clock Results

In unframed binary applications, the Rx clock in can be varied from 500kHz to 9MHz. The following results will be correct over the full frequency range:

- Bit error rate
- Alarm seconds
- Rx frequency

Other measurements (G.821 analysis and frequency offset) are correct at the nominal line rate but unspecified outside its tolerance band.

Option 003 - 704kbit/s Transmit/Receive

Line code: AMI, HDB3, NRZ

Ternary Data Output

Impedance: 120 Ω balanced or 75 Ω unbalanced (nominal).
Pulse Amplitude: 2.37 V \pm 2.37 V (unbalanced), 3 V \pm 3 V (balanced)
Pulse Width: 710 ns \pm 71 ns
Pulse Overshoot: \leq 0.47 V
Pulse Undershoot: \leq 0.47 V
Jitter: typically meets CCITT G.823 section 2.

Binary Data Output

Impedance: 75 Ω unbalanced (nominal)
Format: NRZ Binary
Amplitude: Mark > 3.0 Volts
Space: < 0.5 Volts.

Binary Clock Output

Impedance: 75 Ω unbalanced (nominal)
Format: Square wave, 50 \pm 6 % duty cycle on internal clock
Amplitude: Mark > 3.0 Volts, Space < 0.5 Volts
Polarity: Normal or Inverted.
Tx Clock Source: The Tx can be clocked from the Internal clock or recovered from receiver clock (loop timing) or external clock.

Internal Tx Clock

Frequency: 704 kHz.

Stability: ± 10 ppm temperature 0 - 50 C.

Ageing: ± 2 ppm per year typical

External Tx Clock

Impedance, Format and Threshold: as for 704 kbit/s receiver binary clock input.

Frequency: 704 kbit/s ± 200 ppm.

Looped Timing

Indication: Tx clock loss will be flagged if no clock can be recovered from the received signal.

Spare International (Si) Bits: In framing mode the Si bits can be set to all ones or all zeros, default condition all ones.

Unassigned Frame Bits: In framing mode there are 5 bits (bits 4 to 8 of timeslot zero of NFAS frames). These can be set to any 5-bit pattern, default condition all ones.

Spare Service Bits: In framing mode there are 16 service bits (timeslot zero of frames 13 and 15). These can be set to any 16-bit pattern, default condition all ones.

Spare MFAS Timeslot Bits: In framing mode there are 3 spare bits in timeslot zero of frame 1 (bits 5, 7 and 8). These can be set to any 3-bit pattern, default condition all ones.

Signaling Bits: The ABCD signaling bits can be set to any 4-bit pattern, ALL channels set to the same pattern, default 0101.

Alarm Generation: the following alarm signals can be simulated:

AIS with 2 zeros in 512 bits (true AIS)

AIS with 3 zeros in 512 bits (false AIS)

AIS all ones

Remote alarm (bit 3 of NFAS timeslot set to 1)

Remote multiframe alarm (bit 6 of MFAS timeslot set to 1)

No signal.

Transmitter Timeslot Selection: For Measurement and analysis mode when the transmitter is configured for 704kbit/s, the timeslots can be selected as follows: All timeslots, Single timeslot, n timeslots, for n up to 10.

Timeslot zero is always reserved for framing and signaling. For “single timeslot” or “n timeslots”, any timeslot can be selected except timeslot zero.

Deselected Timeslots: The deselected data timeslots are loaded with either all ones, or a repeating 2^6-1 PRBS (to simulate live traffic).

Tx Error Add - Measurement and Analysis Mode

Bit errors: errors inserted into the test pattern. These will not cause any code or frame errors.

Code errors: violations of the AMI coding rule. These will not directly cause any bit or frame errors but some error extension is possible with HDB3 coding.

Error Add Rate: Errors can either be added singly or at preset rates of 1 in 10^N where N is any number from 2 to 8.

Frame Error Simulation Mode: Special sequences of errors can be generated in any framing timeslot. Timeslot selection for frame simulation is FAS word, NFAS bit or CAS MFAS word.

Mode: Burst, Continuous

FAS Error Simulation: this is used for testing the alarm thresholds of most multiplexers.

Burst: 1 error; 2 errors; 3 errors; 4 errors; 5 errors

Continuous: No errors, 5 in 10^6 , 2 in 10^5 , 5 in 10^4 , 2 in 10^3 , 2 errored FAS words in 4 (sync), 1 errored FAS word in 2 (hold), 3 errored FAS words in 4 (sync loss).

NFAS Error Simulation

Burst: 1 error; 2 errors; 3 errors; 4 errors; 5 errors; hold sync if in sync.

Continuous: No errors, 1 errored NFAS word in 2 (sync gain), 3 errored NFAS words in 4 (sync loss), All errored.

CAS MFAS Error Simulation

Burst: 1 error; 2 errors; 3 errors; 4 errors; 5 errors

Continuous: No errors, 1 errored MFAS word in 2 (multiframe sync gain), All errored (multiframe sync loss)

Ternary Data Input

Rate: 704 kbit/s \pm 100 ppm.

Pulse shape: As per 704 kbit/s Ternary Data Output with between 0 and 6dB of "root f" loss at 352 kHz. In addition, automatic gain control will compensate for flat loss of up to 30dB (for protected monitor points or use with a bridging probe).

Input Impedance: 120 Ω balanced or 75 Ω unbalanced (nominal)

Interference: As per 2 Mbit/s.

Jitter Tolerance: As per 2 Mbit/s.

Binary Data Input

Impedance: 75 Ω unbalanced (nominal)

Format: NRZ Binary

Rate: 704 kbit/s (nominal)

Threshold: 1.4 Volts (nominal)

Binary Clock Input

Impedance: 75 Ω unbalanced (nominal)

Format: Square wave

Frequency: 704 kHz (nominal)

Threshold: 1.4 volts (nominal)

Polarity: Normal or Inverted

Alarm Criteria

AIS: Less than 3 zeros in 512 bits

Signal Loss:

HDB3: 11 or more consecutive zeros. Alarm clears on receipt of a one.

AMI: 16 or more consecutive zeros. Alarm clears on receipt of a one.

NRZ: No receive clock transitions in the last 100 MS. Alarm clears on receipt of a clock transition.

Frame Loss: 3 or more consecutive FAS words in error, or 3 or more consecutive NFAS bits in error. Frame sync is regained when 2 or more consecutive good FAS words are received with no NFAS errors.

CAS Mframe Loss: 2 consecutive MFAS words in error or all zeros in MFAS timeslot. Multiframe sync is regained on the first occurrence of a good MFAS.

Remote Alarm: Bit 3 of all NFAS words set to 1.

Remote Mframe Alarm: Bit 6 of MFAS timeslot frame 1 set to 1.

Receiver Timeslot Selection: For Measurement and analysis mode when the receiver is configured for 704 kbit/s, the timeslots can be selected: as per transmitter; All timeslots; Single timeslot; or n timeslots, for n up to 10. Timeslot zero is always reserved for framing and signaling. For “single timeslot” or “n timeslots”, any timeslot can be selected except timeslot zero.

Pattern sync

Sync Loss, Sync Gain, Resync: As for 2 Mbit/s.

Measurements: frequency count, bit error count, code error count (excluding HDB3 substitutions), frame bit error count.

Timeslot Monitor: The following bits are displayed: Single data timeslot, Frame alignment signal timeslot, Not frame alignment signal timeslot, Frame one timeslot zero (MFAS timeslot), Single signaling channel, all signaling channels; Spare service bits (timeslot zero frames 13 and 15).

No measurements are provided in timeslot monitor. However, all of the relevant alarms, except PATTERN SYNC LOSS, are detected and are available on the front panel.

Option 004 - Small Siemens Connectors

Small Siemens Connectors replace the four BNC connectors on the unbalanced ports.

Option 005 - Sub rate testing, timeslot access, tone generation and measurement.

- CCITT Recs. X.50 divisions 2 and 3, X.50 bis and X.58 sub-64 kbit/s testing
- External X.21 data access to n unstructured 64 kbit/s timeslots within a 2 Mbit/s signal (n = 1 to 6), or to a single structured (X.50/X.58) 64 kbit/s timeslot
- Internal talk/listen to a single timeslot
- 600 Ω audio access to a single unstructured timeslot
- Tone generation and measurements

X.21 Data Access

Rate: Unstructured n x 64 kbit/s timeslot, n = 1 to 6

Rate: Structured (X.50/X.58) sub-64 kbit/s

6-36 General Information

Mode: DCE

Connector: X.21-leased: 15-pin D-type

Audio Access

External drop/insert of one unstructured 64 kbit/s timeslot

Input and Output Connectors: 3-pin Siemens

Impedance: 600 Ω balanced (nominal)

TLP: 0.0dB (nominal)

Codec: A-law

Level: +3dBm to -50dBm

X.50 48-kbit/s

Framed 48kbit/s in both Division-2 and Division-3 frame formats are provided. Access is provided via the X.53 numbering scheme.

X.50 & X.58 AIS

The ability to generate and measure “all-1’s” as AIS is provided.

X.50 Frame error add

The ability to generate errors into the X.50 and X.58 frame structure is provided at the rates 1E-2, 1E-3, 1E-4, 1E-5, 1E-6.

X.50 14.4 & 19.2kbit/s

The ability to determine the phases which carry the payload is provided. This facility is set on the “OTHER” page under X.53 setting and the choices of phase separation are coded “1”, “2”, “3” and “4” The phases selected with these codes are given in the following table:

code 1	phase separation 1&2, 2&3, 3&4, 4&5
code 2	phase separation 1&3, 2&4, 3&5
code 3	phase separation 1&4, 2&5
code 4	phase separation 1&5

The ETSI compliant and HP default is “1”.

X.58-ETSI

This format (previously known as “X.58-PTT-NL”) is available.

Internal talk/listen

Rate: one 64 kbit/s timeslot Speaker/microphone

Tone generation and measurement

Tone Generation

Into n 64 kbit/s timeslots, n = 1 to 31

Level: 0 dBm0 to -55 dBm0 in 5 dB steps

Accuracy: 0 dBm0 to -50 dBm0: ± 0 dB
-55 dBm0: ± 0.3 dB

Set frequencies: 404, 1008, 2100, 2804 Hz

Accuracy: ± 1 Hz

User-definable frequency: 100 Hz to 3.9 kHz

Resolution: 1 Hz

Accuracy: ± 15 Hz

Tone Measurement

In selected 64 kbit/s timeslot

Code word measurements

Results range: 0 to ± 127

Offset range: 0 to ± 16

Signal level

Results range: -80 to +3dBm0

Resolution: 0.1 dB

Accuracy: -40 dBm0 to +3 dBm0: ± 0.1 dB
-60 dBm0 to -40dBm0: ± 0.5 dB

Channel frequency

Range: 100 Hz to 3.90 kHz

Resolution: 1 Hz

Accuracy: ± 1 Hz, ± 100 ppm

Minimum input level: -60 dBm0

A-law Code Word

6-38 General Information

Offset range: -99 to +99 (mean dc level)

Peak: +1 to +127, -1 to -127

Sub-64 kbit/s testing

Testing of sub-64 kbit/s data signals to CCITT Recs. X.50 divisions 2 and 3, X.50 bits and X.58.

Structured bearer signal: a 64 kbit/s codirectional signal or one timeslot within a 2 Mbit/s signal (without CAS multiframe).

Modes of operation: Transmit/receive, through mode

Test Patterns

PRBS: CCITT Rec. O.151: 2^9-1 , $2^{11}-1$

Word: Fully programmable word (octet aligned): 14 bits for X.50; 16 bits for X.58.

External pattern: Via X.21-leased port

Deselected sub-rate channel contents

X.50: F0000000 or F0101010 or F1111110 or F0000001

X.58: 11111111 or 01010101

Network Bits: user controllable: X.50 division 2: FAS bits A to H; division 3: FA bit A; X.58: T1 to T4 (T1 contains bits A to H).

Pattern sync

Sync loss: When error ratio exceeds 10% for PRBS, 4% for word, over 100 ms

Sync gain: After n error-free consecutive bits, where n is:

Pattern	X.58 Bits	X.50 Bits
2^9-1	17	15
$2^{11}-1$	19	17
word	24	18

Error Add

Bit: Single, variable rate 10^n where $n = 2$ to 6.

Frame: 1 to 32 consecutive frame bits

Through mode: All except the selected circuit are copied from the receiver port

to the transmitter port. For 2.048Mbit/s, the non selected timeslots are copied across. The time order of the sub-64 kbit/s structure timeslot relative to the other timeslots may be disturbed. The CRC will be recalculated. The test set generates the selected mapping.

Frame Error Add

Burst: A number of consecutive frame octets (X.58) or consecutive frame bits (X.50 div 2 and 3) may be errored. X.50 note: frame bit positions that are used for network bits are not errored, i.e. are skipped.

Rate: The ability to generate errors into the X.50 and X.58 frame structure is provided at the rates 1E-2, 1E-3, 1E-4, 1E-5 and 1E-6.

AIS

The ability to generate and measure "all-ones" as AIS is provided.

Results

Bit errors, frame errors

Accuracy: ± 1 count (error count period ± 30 ms).

Alarms: (indicated by status line message and LED) frame loss, pattern loss, remote alarm

Octet monitor: displays the contents of any selected octet within the user channel. Monitors the information bits and the network bits

Circuit numbering

X.53 details numbering of the channels for X.50 and X.58 (on the user-interface).

Number	1	2	3 4
	1 = Division 2	3 = 600 bit/s	N N = first octet in the frame
	2 = Division 3	4 = 2.4 kbit/s	which carries the circuit.
		5 = 4.8 kbit/s	
		6 = 9.6 kbit/s	
		7 = 14.4 kbit/s	
		8 = 19.2 kbit/s	

e.g. 1304 means a Division-2, 600 bit/s signal transmitted on octet 4 of the frame.

6-40 General Information

X58 - ETSI

- X.58-NL-PTT pattern generation and measurement. X.58-NL-PTT is a sub-64 kbit/s data structure, being developed by ETSI, which is similar to CCITT Rec. X.58.
- External X.21 data access to an unstructured 64 kbit/s timeslot or a single structured (X.58-NL-PTT) 64 kbit/s timeslot of a 2 Mbit/s signal.
- Internal talk/listen to a single timeslot of the primary data stream via a PCM codec.
- 600 Ω audio access to a single timeslot of the primary data stream via a PCM codec.

X.21 Data Access

Rate: an unstructured 64 kbit/s timeslot, or a sub-rate structured circuit.

Connector: X.21-leased: 15-pin D-type side panel

Mode: DCE

Audio Access

External drop/insert of one unstructured 64kbit/s timeslot.

Input and Output

Connector: 3 pin Siemens

Impedance: 600 Ω balanced (nominal)

TLP: 0.0dB (nominal)

Codec: A-law

Level: +3dBm to -50dBm

Internal talk/listen

Rate: one 64 kbit/s timeslot Speaker/microphone

X.58-NL-PTT Testing

The 64 kbit/s structured signal may be either one timeslot within a 2.048 Mbit/s signal (without CAS multiframe) or a 64 kbit/s co-direction signal.

Patterns

PRBS: CCITT Rec. O.151: 2^9-1 , $2^{11}-1$

User programmable word; octet aligned (16-bits)

External pattern via X.21-leased port

Deselected sub-rate channel contents: 11111111 or 01010101

Pattern sync

Sync loss: When error ratio exceeds 10% for PRBS, 4% for word, over 100 ms

Sync gain: After n error-free consecutive bits, where n is:

pattern	bits
2^9-1	17
$2^{11}-1$	19
word	24

Error Add

Bit: Single, variable rate 10^n where $n = 2$ to 6.

Frame: 1 bit of 1 to 32 consecutive frame bytes.

Through mode

The instrument retransmit the recovered received data, except the selected circuit. The time order of the sub-64 kbit/s structure timeslot relative to the other timeslots may be disturbed. The CRC will be recalculated. The test set generates the selected mapping.

Results

Bit errors, frame errors

Accuracy: ± 1 count (error count period ± 30 ms)

Alarms

(indicated by status line message) Frame Loss, remote alarm, Pattern loss.

X.58 Structure

X.58 uses an 80-octet frame with a number of octets from the frame for network use. An octet selected from within the user channel may be displayed on the timeslot monitor page, as are the network octets.

6-42 General Information

There are 106 different uses of the 80 bytes frame. Each number refers to a different rate or mapping of rate.

Any mapping, 1 to 106 excluding circuits 55 and 94, may be used for stimulus and/or measurement. The same mapping is used for transmit and receive.

Frame alignment signal

name	binary	byte no.
X1	11100100	0
X2	10100000	42

Frame alignment

In search mode or maintenance mode. The transition from search to maintenance occurs when a 4 octet sequence X1,X2,X1,X2 is detected without error and no other sequence X1,X2,X1 is detected elsewhere in these two frames.

Timeslot monitor: Displays the contents of any selected octet within the user channel.

Option 006 Timeslot Access, Tone Generation and Measurement.

Option 006 adds to the standard HP 37722A/32A

- External X.21 data access to n unstructured 64 kbit/s timeslots within a 2 Mbit/s signal (n = 1 to 6)
- Internal talk/listen to a single timeslot
- 600 Ω audio access to a single timeslot
- Tone generation and measurements

X.21 Data Access

Rate: Unstructured n x 64 kbit/s timeslot, n = 1 to 6

Mode: DCE

Connector: X.21-leased: 15-pin D-type

Audio Access

External drop/insert of one unstructured 64 kbit/s timeslot

Input and Output

Connectors: 3-pin Siemens
Impedance: 600 Ω balanced (nominal)
TLP: 0.0dB (nominal)
Codec: A-law
Level: +3dBm to -50dBm

Internal talk/listen

Rate: one 64 kbit/s timeslot Speaker/microphone

Tone Generation and Measurement

Tone Generation

Into n 64 kbit/s timeslots, n = 1 to 31
Level: 0 dBm0 to -55 dBm0 in 5 dB steps
Accuracy: 0 dBm0 to -50 dBm0: ± 0 dB
 -55 dBm0: ± 0.3 dB

Set Frequencies: 404, 1008, 2100, 2804 Hz
Accuracy: ± 1 Hz
User-definable frequency: 100 Hz to 3.9 kHz
Resolution: 1 Hz
Accuracy: ± 15 Hz

Tone Measurement

In selected 64 kbit/s timeslot

Code word measurements

Results range: 0 to ± 127
Offset range: 0 to ± 16

Signal level

Results range: -80 to +3dBm0
Resolution: 0.1 dB
Accuracy: -40 dBm0 to -3 dBm0: ± 0.1 dB
 -60 dBm0 to -40 dBm0: ± 0.5 dB

6-44 General Information

Channel frequency

Range: 100 Hz to 3.90 kHz

Resolution: 1 Hz

Accuracy: ± 1 Hz ± 100 ppm

Minimum input level: -60 dBm0

A-law Code Word

Offset range: -99 to +99 (mean dc level)

Peak: +1 to +127, -1 to -127

Option 210

The following features comprise option 210:

- M.2110 : Evaluation of test pass/ fail 1 day and 7 day periods, relative to user defined "Allocation percentage"; ie 2 additional measurements.
- M.2120 : Evaluation of path performance with internal logging of the occurrence of 15minute and 24hour report results, relative to performance specified by user entered "Allocation percentage"; ie 2 additional measurements.
- Measurement timed start : The ability to start a measurement at a specific time and date; eg mid-night on 1st Jan 1999.
- Print on time interval : The ability to print results at regular intervals (15 mins/1 hr/24 hr).

M.2110 & M.2120

Interface

M.21XX measurements are only available when the HP 37732 is measuring a 2.048Mbit/s signal.

Path Allocation

Range: 0.5% to 40.0% in 0.5% steps.

M.2110

M.2110 results of "WAIT", "PASS", "FAIL" are provided for both 24 hour and 7 day tests, based on limits derived from user entered PA% (Failure if S2 is reached or exceeded, pass if S1 is not reached)

M.2120

TR1 and TR2 reports are generated based on limits derived from user entered PA% (and for TR2 BIS factor %). Such events are counted.

M2120 reports are generated only in available time.

Limits and Path Allocation

The user enters the Path Allocation as a percentage. From this is determined the M.2110 "S1" and "S2" limits, and the M.2120 TR1-ES, -SES and TR2-ES, -SES limits as detailed in CCITT documents. The TR2 limits may be scaled from the 24 hour BIS limits, calculated in accordance with M.2110.

TR2 range: 50% to 150% in 1% steps

Graphs and Logging

Graphical storage of M.2110 results are not provided as they can be determined from the storage of sources; eg frame error.

The occurrence of M.2120 TR1 and TR2 results may be logged to internal storage; 4 tracks:- RX-TR1, TX-TR1, RX-TR2, TX-TR2

Time stamping

The occurrence of a event can be determined from its position on the internal graphs.

Accuracy: ± 10 seconds.

Timed start

The ability to start a measurement at a user specified time and date is provided.

Resolution: Hour, Minute, Day, Month, Year.

Printing The ability to print a summary of all current settings and counts at 15 minute, 1 and 24 hour intervals is provided. The content and form is the same as that of the "print-now" feature.

Option B12

Internal, rechargeable battery power source .

Option B48

External battery operation.

Option H02

HP-IB remote control instead of RS-232.

Option H08

Suppression of bit error recording during Pattern sync loss.

Option V01

Virtual remote operation (needs HP 15800A virtual remote software).

Option 010 - Relative Frequency**Summary**

A (simultaneous) measurement of frequency relative to a (rear panel) AMI/HDB3 signal is available. Other derived measurements include estimated positive and negative bit slips.

Compatibility

This option is not available for instruments with battery (Option B01, or 48 volt power supply).

Connector

BNC on rear panel.

Electrical

Same as front panel ternary input, see section 2 *Mbit/s RECEIVER*.

Results

- Relative frequency, in range -200 to $+200$ ppm.
- Peak Wander (positive and negative), in UI.
- Cumulative positive and negative (estimated) bit slips.
- Graph showing current instantaneous wander, range ± 256 UI.

Installation

Introduction

This section provides installation instructions for the Hewlett-Packard Model HP 37722A Digital Telecom Analyzer. This section also includes information about initial inspection, preparation for use, packaging, storage and shipment.

Initial Inspection

Warning



To avoid hazardous electrical shock, do not perform electrical tests when there are signs of shipping damage to any portion of the outer enclosure (covers, panels, meters and so on).

Inspect the shipping container for damage. If the shipping container or cushioning material is damaged, it should be kept until the contents of the shipment have been checked for completeness and the instrument has been checked mechanically and electrically. Procedures for checking electrical performance are given in Chapter 8 of this manual. If the contents are incomplete, if there is mechanical damage or defect or if the instrument does not pass the Performance Tests, notify the nearest Hewlett-Packard office. If the shipping container is damaged or the cushioning material shows signs of stress, notify the carrier as well as the Hewlett-Packard office. Keep the shipping materials for the carrier's inspection. The HP office will arrange for repair or replacement at HP option without waiting for claim settlement.

Preparation for Use

Warning



To avoid the possibility of injury or death, the following precautions must be followed before the instrument is switched on.

- A. Note that the protection provided by grounding the instrument cabinet may be lost if any power cable other than the three-pronged type supplied is used to couple the ac line voltage to the instrument.
 - B. If this instrument is to be energized via an auto-transformer to reduce or increase the line voltage, make sure that the common terminal is connected to the neutral pole of the power source.
 - C. The power cable plug shall only be inserted into a socket outlet provided with a protective earth contact. The protective action must not be negated by the use of an extension cord without a protective conductor (grounding).
 - D. For operator protection during battery operation, connect the chassis terminal on the rear panel to earth ground.
-

Power Requirements

The instrument requires a power source of 95 to 240V ac $\pm 10\%$, 48 to 66 Hz single phase, or can be powered from a Battery (Option B12). The instrument's power consumption is less than 60 VA.

Line Fuses

Two line fuses are required, they are located in the line power input module on the side panel. The correct rating is 250V, 1 A Timed (HP 2110-0782).

Caution



Before connecting the instrument to a power outlet ensure that the fuses are correctly rated.

Power Cable

This instrument is equipped with a three-wire power cable. When connected to a properly grounded power outlet, this cable grounds the instrument case. The type of power cable supplied with each instrument depends on the country of destination. Refer to the following figure for the part numbers of the power cables and plug configurations available. If the appropriate power cable is not included with the instrument, notify the nearest Hewlett-Packard Sales and Service Office and a replacement will be provided.

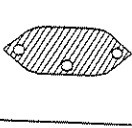
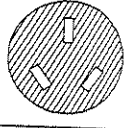
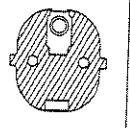
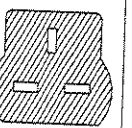
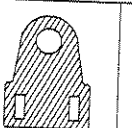
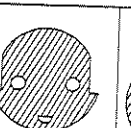
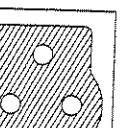
						
8120-2104	8120-1369	8120-1689	8120-1351	8120-1378 US 8120-4753 JAP	8120-2956	8120-4211

The color code used in each power cable is given below:

Line Brown
 Neutral Blue
 Ground Green/yellow

Battery (Option B12)

Warning



For operator protection during battery operation, connect the chassis terminal on the rear panel to earth ground.

Two 6 V 3 Ah lead acid batteries (HP 1420-0123) are located inside the battery compartment at the rear of the instrument.

The instrument will run with fully charged batteries (at an ambient temperature of 25 degrees centigrade) for nominally 1.5 hours with settings and results displayed or 2 hours with the display blanked.

Power consumption is optimized by automatically blanking the display if there is greater than 2 minutes between key presses. Pressing any key re-displays settings.

When the instrument detects that the battery voltage is low, it displays a **Battery low !!!!** status message. This message remains displayed until the battery voltage drops below the minimum level that guarantees valid results. When this condition is reached, there is an automatic instrument power down and the red **LOW BATTERY** indicator on the side panel then flashes to show the batteries require re-charging.

It is recommended that the batteries be re-charged as soon as possible to optimize battery life.

To Charge the Batteries (Option B12)

Caution



To avoid over charging, do not use an external charger. The instrument has its own charging circuit.

Connect the ac power cord, the green **CHARGING** indicator lights - full charge is obtained after 9 hours at 25 degrees centigrade. The battery charges with the power switch in the **ON** or **STANDBY** position.

To Change the Batteries

Warning



The battery should only be changed by someone who is aware of the hazards involved.

Do not short circuit the battery terminals, it may cause serious personal injury.

Do not incinerate or otherwise mutilate the battery. It might burst or release toxic materials causing personal injury.

1. Ensure that the instrument power switch is set to *STANDBY* and disconnect the ac power cord (if one is connected).
2. Remove the eleven securing screws on the rear panel then remove the back-plate.

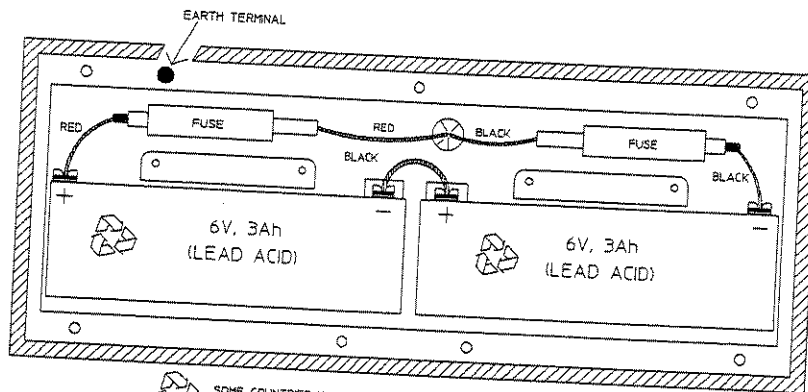

3. Disconnect the batteries.
4. Replace the batteries.
5. Re-connect the new batteries.

Battery Fuses

Two 5 A fast blow fuses (HP 2110-0010) are located inside the battery compartment at the rear of the instrument (see figure above).

To Change a Blown Fuse

1. Ensure that the instrument power switch is set to *STANDBY* and disconnect the ac power cord (if one is connected).
2. Remove the eleven securing screws on the rear panel then remove the back-plate.
3. Disconnect the batteries.

4. Replace blown fuse.
5. Re-connect the batteries.

Mating Connectors (Front and Side Panels)

Connectors which mate with the Telecom/Datacom Analyzer are listed below.

Telecom/Datacom Analyzer Port	Connector type	Mating Connector Part Number
CLOCK OUT	BNC	1250-1448
SIGNAL OUT	Siemens (3-pin)	1252-3033
SIGNAL OUT	BNC	1250-1448
CLOCK IN	BNC	2150-1448
SIGNAL IN	Siemens (3-pin)	1252-3033
SIGNAL IN	BNC	1250-1448
RS-232	25 W D SUBMIN	HP 1251-0063 (plug) HP 1251-1438 (hood)
DATACOM	15 W D SUBMIN	HP 1251-0221 (plug) HP 1251-1550 (hood)
600 Ω AUDIO I/P	Siemens (3-pin)	1252-3033
600 Ω AUDIO O/P	Siemens (3-pin)	1252-3033

T1 Tester Selection When Using a T1/DATACOM TEST SET

The T1 Tester may form part of a T1/Datacom Test Set. To select T1 operation, set the DATACOM MODULE, TEST SELECT to T1.

External Clock Input

The front panel CLOCK IN port, accepts an external clock when the **SETTINGS** APPLICATION, TX CLOCK SOURCE offers **EXTERNAL** as a choice. The clock input must be within 200ppm of the nominal frequency. For 64 kbit/s operation from external clock, the input required is 256 kbit/s \pm 200 ppm.

ACCESSORY Port - for Datacom Module Connection

Caution



The Datacom-lid cable must only be connected or disconnected with the instrument powered down.

RS-232 Port - for Printer or Remote Control Connection

Caution



This port is located on the side panel of the HP 37732A or HP 37722A and is NOT to be confused with the RS-232/V.24 port on the Datacom Module.

This port is a full duplex RS-232 serial interface configured as Data Communications Equipment (DCE). This port can be connected directly to printers, dumb terminals and controllers which are configured as Data Terminal Equipment (DTE).

Using an adapter cable (see page 7-9), this port can also be connected to modems and other devices which are configured as DCE.

The *RS-232* connector pinout configuration and signal flow are shown in the following diagram:

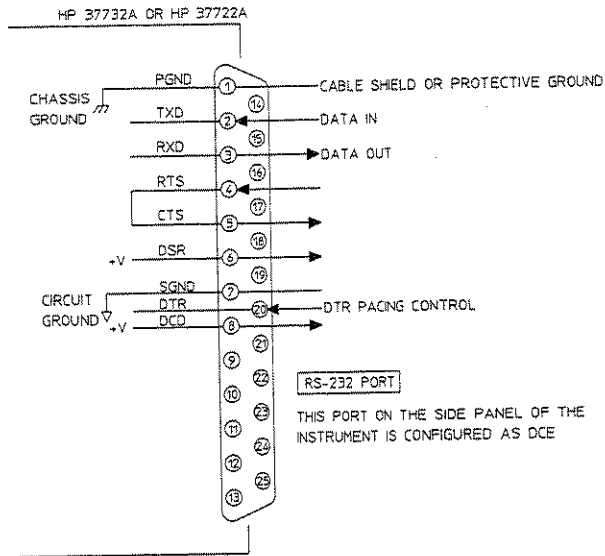

The *RS-232* port can only transmit or receive asynchronous data, any device connected to it must be set for asynchronous operation. The character formats for Printer and Remote Control are as follows:

	Printer Operation	Remote Control
Baud Rate	300, 600, 1200, 1800, 2400, 4800 or 9600	
Data Bits	8	7
Parity	None	Odd, Even, Zeros, Ones
Stop Bits	1 or 2	
Pacing	ENQ/ACK, Xon/Xoff or DTR	ENQ/ACK, Xon/Xoff (RX only) (TX only) (RX & TX or off)

For more details on Printer operation and Remote Control, see Chapters 5 and 9 respectively.

7-8 Installation

Modem Connection

Only a full duplex modem may be used. The cable connecting the *RS-232* port to the modem should be configured as follows:

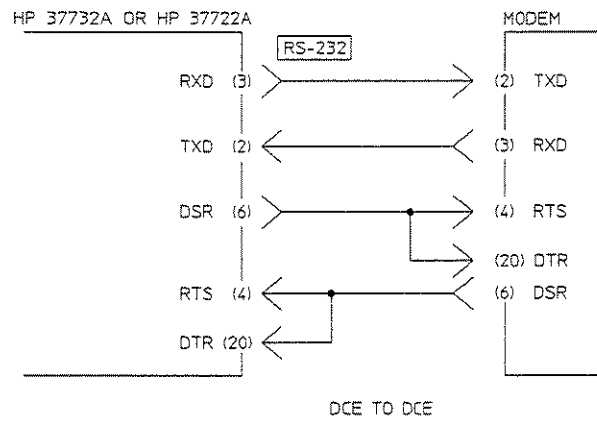

Rack Mounting

The general purpose rack mount kit, HP part number 37701-60050, comprises the following parts:

Main instrument

Two brackets HP part number 37701-00048.

Accessory lid

Two brackets HP part number 37701-00049.

Four screws

Four spacers

To fit the rack mount kit:

Main instrument

Remove the front corner "feet", 12 screws (C).

Fit the rack mount brackets over the fixed part of the protective front cover retaining catch.

Fix the brackets to the instrument with 4 of the original screws (C)

NOTE : the screws have fine threads. Care should be taken not to overtighten the screws during replacement as the threads in the casting could be damaged.

If there is no accessory lid, discard the surplus kit parts.

Accessory lid

Remove the 4 screws from beneath the latch catch and remove the assembly from the plastic cover,

Remove the latch catches by removing the nuts and washers on the inside of the plastic cover.

Refit the assembly inside the plastic cover.

Place the brackets, items (1) and (2) in position and fix using screws (5) and spacers (4) supplied.

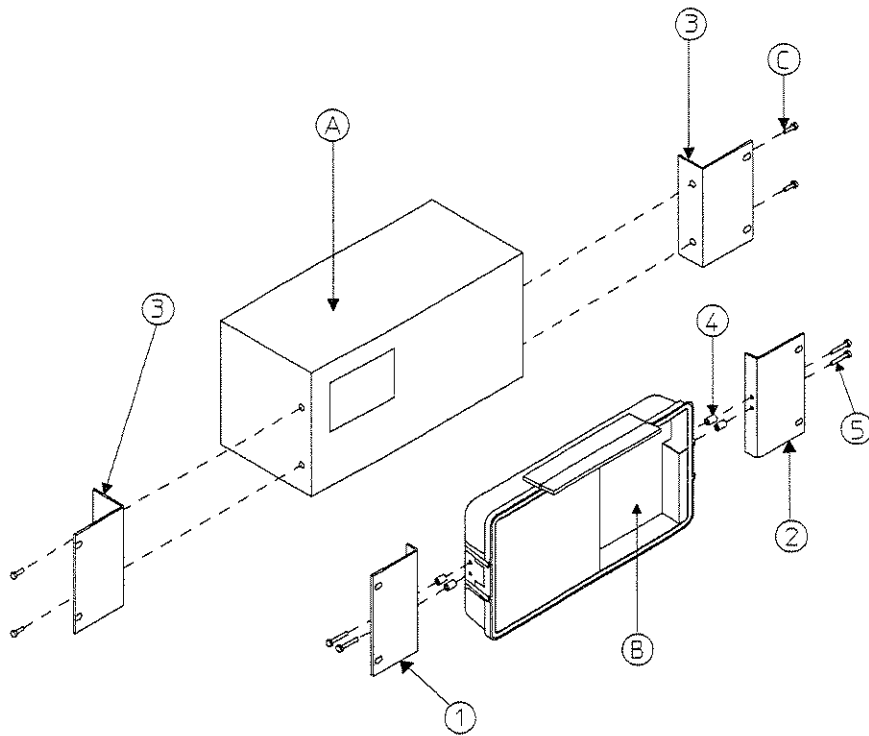

Rack Mount Kit HP Part No. 37701-60050

DATACOM Port - for Drop and Insert Interface

This 15 way D SUBMIN port provides an interface between a datacom signal source, for example a protocol analyzer, and the drop and insert capability of the instrument. The pin connections of this port are shown in the following table.

PIN CONNECTION	
1	GND
2	TXD A
3	CON A
4	RXD A
5	IND A
6	TXC A
7	RXC A
8	GND
9	TXD B
10	CON B
11	RXD B
12	IND B
13	TXC B
14	RXC B
15	-

Operating Environment

- Temperature The instrument may be operated in temperatures from 0 degrees centigrade to +50 degrees centigrade. The temperature for battery operation is 0 degrees centigrade to +40 degrees centigrade.
- Humidity The instrument may be operated in environments with humidity up to 95% at 40 degrees centigrade. However, the instrument should also be protected from temperature extremes which may cause condensation within the instrument.
- Altitude The instrument may be operated at altitudes up to 4,600m (15,000 ft).
- Air Flow To provide adequate cooling, an air gap of approximately 3-inches should be maintained around the instrument.

Storage and Shipment

Environment

The instrument may be stored or shipped in environments within the following limits:

- Temperature -40 degrees centigrade to +75 degrees centigrade without a battery and -20 degrees centigrade to +55 degrees centigrade with a battery.
- Humidity 90%
- Altitude 15,300m (50,000 ft)

The instrument should also be protected from temperature extremes which may cause condensation within the instrument.

Packaging

Tagging for Service

If the instrument is being returned to Hewlett-Packard for service, please complete one of the blue repair tags located at the front of the service manual (if you have one) or give details on a label then attach the tag or label to the instrument.

Original Packaging

Containers and material identical to those used in the factory packaging are available through Hewlett-Packard offices. If the instrument is being returned to Hewlett-Packard for servicing, attach a tag indicating the type of service required, return address, model number and full serial number. Also mark the container "FRAGILE" to ensure careful handling.

Other Packaging

The following general instructions should be used for re-packing with commercially available materials:

- a. Wrap instrument in heavy paper or plastic. (If shipping to Hewlett-Packard office or service center, attach a tag indicating type of service required, return address, model number and full serial number.)
- b. Use strong shipping container. A double-walled carton of 35-pound test material is adequate.
- c. Use a layer of shock absorbing material 70 to 100 mm (3 to 4 inch) thick around all sides of the instrument to provide firm cushioning and prevent movement inside the container. Protect the control panel with the front cover provided or with cardboard.
- d. Seal shipping container securely.
- e. Mark the shipping container clearly.
- f. In any correspondence, refer to instrument by model number and full serial number.

Performance Tests

Introduction

This chapter contains procedures which test that the following instruments meet the electrical performance specifications given in Chapter 1:

- HP 37722A Telecom Analyzer
- HP 15901A Datacom accessory when fitted to the HP 37722A Telecom Analyzer
- HP 37732A Telecom/Datacom Analyzer

There are two levels of performance testing contained in this chapter:

- Operational Verification Provides >90% confidence that the instrument is operating to its full warranted specification.
- Full Performance Test Ensures that the instrument is operating to its full warranted specification.

Results Tests may be recorded on the Test Records which follow each of the groups of tests.

The arrangement of test procedures and test records in this chapter is as follows:

- Telecom analyzer operational verification, procedures
- Telecom analyzer operational verification, test record
- Telecom analyzer performance test, procedures
- Telecom analyzer performance test, test record
- Datacom analyzer performance test, procedures
- Datacom analyzer performance test, test record

Calibration Cycle

Results recorded on the Test Record at incoming inspection can be used for comparison in yearly maintenance and calibration or after repairs or adjustments.

Recommended Test Equipment

The test equipment required is listed in the following table. Equipment which meets or exceeds the critical specifications may be substituted for the recommended model.

Recommended Test Equipment

Instrument	Critical Specification	Recommended Model
Signature Multimeter	Unique	HP 5005B
Frequency Counter	0.0003% accuracy up to 4.32 MHz for telecom tests, 0.00015% accuracy up to 2.048 MHz for datacom tests	HP 5316B OPT 001
Printer	80 column HP-IB printer	HP 2225A Thinkjet
Synthesizer / Level Generator	75 Ω unbalanced output. Sinewave frequency range 1 kHz to 4.3 MHz; Level range 0dBm to -21dBm	HP 3335A
Synthesizer / Level Generator	600 Ω balanced output. Sinewave frequency range 1 kHz; Level range 0dBm	HP 3336A
Oscilloscope	100 MHz bandwidth; Dual I/P	HP 54201A/D
Impedance Converter (2)	120 Ω balanced (nominal) to 75 Ω unbalanced (nominal)	HP 15508C

8-2 Performance Tests

Instrument	Critical Specification	Recommended Model
Accessory cable	Unique	HP 15901-60002
RS-232 Loopback connector	Unique	HP 5060-4462
60Ω Termination network	Unique	see Transmitter Output Test
15 way connector	15 way D-Shell connector mode	HP 1251-5503
Siemens 3-pin to 3-pin cable	Unique	HP 15512A
BNC to BNC (2)	Unique	HP 15525A
10 : 1 Divider Probe	Unique	HP 10435A
75Ω Terminator (2)	75Ω ± 1%	HP 15522-80010
T Connector (2)		
Dual BNC to Siemens 3-pin Cable	see Transmitter Output Test	
RS-232/V.24 Mating Connector	_____	HP 1251-0063
RS-449/V.11 Mating Connector	_____	HP 1251-4586
Test Pin (2 off)	_____	HP 0360-0535
24 Gauge Jumpered Wire	_____	

Operational Verification, Telecom

The Operational Verification tests quickly establish with >90% confidence that the HP 37701A meets the specifications listed in Chapter 1. If any test fails to meet specification, refer to the Adjustments in chapter 4. If after adjustment the specification still cannot be met, refer to the troubleshooting in chapter 5.

Default Settings

Description

The instrument default settings are factory preset and will be called to reconfigure the instrument when the following procedure is performed.

Procedure

1. Press **OTHER**.
2. Press the **STORED SETTINGS** softkey.
3. Select STORED SETTING NUMBER and press **0**, is the default. Use **↑** and **↓** to highlight this field.
4. Select ACTION (again using the **↑** and **↓** keys) and press **RECALL**.
5. Now press **SETTINGS** to display the 2Mb/s default settings.

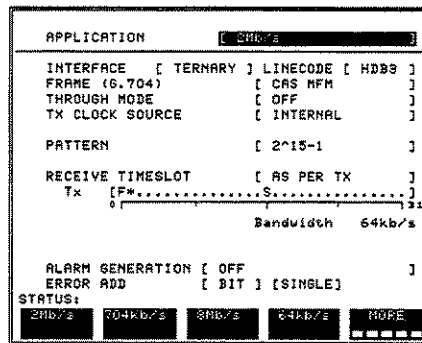

Operational Verification, Telecom



Self Test, Telecom

Description

These tests give a high degree of confidence that the instrument is operating to it's warranted specification. A description of each test is given on page 8-9.

Equipment

RS-232 Loopback Connector : HP 5060-4462

15 Way Connector (X.21) : HP 1251-5503 (required for instruments with Option 005)

Procedure

1. Connect the HP 37722A SIGNAL OUT 75 Ω Unbalanced port to the SIGNAL IN 75 Ω Unbalanced port (front panel).
2. Connect the CLOCK OUT port to the CLOCK IN port.
3. Connect the RS-232 loopback connector to the RS-232 port (right hand side panel of the instrument). Alternatively use wire links to either modify an RS-232 connector or connect across the RS-232 port as shown below.

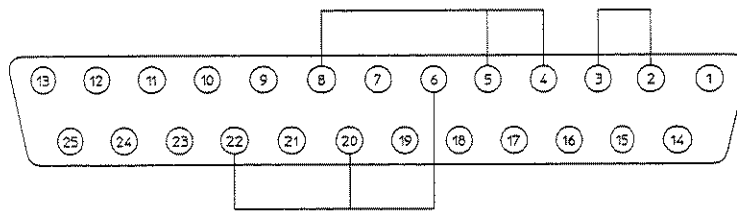

RS-232 Connections

4. **Option 005 only.** Take the 15 way connector (1251-5503) and use wire links to connect pins 2 to 4 and 9 to 11 (see the following figure). Connect the modified 15 way connector to the DATACOM connector (left side of instrument), this gives the required X.21 loopback.

Self Test, Telecom

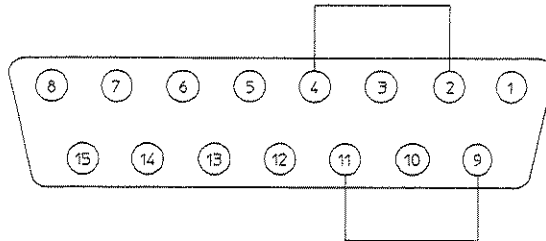

15 way connections on the pin side of HP 1251-5503

5. Press HP 37722A **OTHER**, select **SELF TEST** (use **MORE** to bring up the SELF TEST field) and set the TEST TYPE for ALL TESTS.
6. Press HP 37722A **START/STOP** and verify that "TEST STATUS PASSED" is displayed at the end of ALL TESTS, approximately 12 minutes.
7. Disconnect the HP 37722A cables from the front panel connectors.
8. Connect the SIGNAL OUT Siemens 3-pin 120 Ω Balanced port to the SIGNAL IN Siemens 3-pin 120 Ω Balanced port (front panel).
9. Verify that the SIGNAL PRESENT front panel status led is the only led on (the HISTORY led may be on due to previous signal conditions).

Note



If a self test fails each test can be run individually to discover the extent of the instrument malfunction. Refer to the service manual Troubleshooting to find out how to correct this failure.

Telecom Self Tests, Order and Fail Codes

When ALL TESTS is selected the individual tests (1 to 12) are performed in the order shown in the following table. Test 1 is a general test of the Control Processor Unit (CPU). Tests 2 to 11 use a comparison of measured results and expected results. The measurements are made on signals which are externally looped back from transmitter to receiver. Test 12 verifies Option 005 operation. If a test failure occurs, the failure code displayed indicates the part of the individual test which has failed. The test which failed is indicated by the group of failure codes shown in the following table. A more detailed list of fail codes is given in the service documentation.

Fail Code Group	Test	Test Number
1 to 1099	CPU	1
2000 to 2999	Pattern	2
3000 to 3999	Frame	3
4000 to 4999	Line Code	4
5000 to 5999	Timeslot	5
6000 to 6999	Error Add	6
7000 to 7999	Frame Error	7
8000 to 8999	Alarms	8
9000 to 9999	Signal	9
10000 to 10999	Bit	10
11000 to 11999	Clock Recovery	11
12000 to 12999	Sub Rate	12

Internal Transmitter Clocks

Specifications

Frequency: 2.048 MHz

Stability: ± 10 ppm temperature 0 - 50 C

Ageing: ± 2 ppm per year (typical)

Frequency: 64 kHz.

Stability: ± 10 ppm temperature 0 - 50 C

Ageing: ± 2 ppm per year typical

Frequency: 8.448 MHz (Option 002)

Stability and ageing: as for 2 Mbit/s transmitter

Frequency: 704 kHz (Option 003)

Stability: ± 10 ppm temperature 0 - 50 C.

Ageing: ± 2 ppm per year typical

Description

This test verifies that the transmit data rates are within 12PPM with the provision that the instrument has been through it's yearly calibration cycle.

Note: The Frequency Counter triggers off of the positive pulses only, this results in a frequency count of half the selected data rate.

Equipment

Frequency Counter : HP 5316B Option 001

75 Ohm Termination : HP 15522-80010

T Connector

Procedure

1. Recall the HP 37722A DEFAULT SETTINGS as shown on page 8-5.
2. Connect the HP 37722A SIGNAL OUT 75 Ω Unbalanced port to the Frequency Counter. Terminate the Frequency Counter input in 75 Ω (use the T Connector).

8-10 Performance Tests

Internal Transmitter Clocks

2.048 MHz

3. Press HP 37722A **SETTINGS** and select the following:

APPLICATION	[2Mb/s]			
INTERFACE [TERNARY]	LINECODE [AMI]			
FRAME (6.704)	[OFF]			
TX CLOCK SOURCE	[INTERNAL]			
PATTERN	[1111]			
ERROR ADD [BIT]	[SINGLE]			
STATUS:				
2Mb/s	704kb/s	3Mb/s	64kb/s	NOPE

4. Ensure that the Frequency Counter reads between 1024012.3 Hz and 1023987.7 Hz.

64 KHz

5. Press HP 37722A **SETTINGS** and select the following:

APPLICATION	[64kb/s]			
INTERFACE	[CODIRECTIONAL]			
TX CLOCK SOURCE	[INTERNAL]			
CODIR OCTET TIMING	[OFF]			
PATTERN	[1111]			
ERROR ADD (BIT)	[SINGLE]			
STATUS:				
2 ²⁸ -1	2 ¹⁵ -1	2 ¹¹ -1	1111	NOPE

6. Ensure that the Frequency Counter reads between 32000.384 Hz and 31999.616 Hz.

Internal Transmitter Clocks

8.448 MHz (Option 002 only)

7. Press HP 37722A **SETTINGS** and select the following:

APPLICATION	[8Mb/s]				
INTERFACE	(TERNARY)	LINECODE	(HD30)		
PATTERN	[1111]				
ERROR ADD	[BIT]	[SINGLE]			
STATUS:	<input type="checkbox"/> 2 ²³ -1	<input type="checkbox"/> 2 ¹⁹ -1	<input type="checkbox"/> 2 ¹¹ -1	<input type="checkbox"/> 1111	<input type="checkbox"/> MORE

8. Ensure that the Frequency Counter reads between 4224050.7 Hz and 4223949.3 Hz.

704 KHz (Option 003 only)

9. Press HP 37722A **SETTINGS** and select the following:

APPLICATION	[704kb/s]				
INTERFACE	[TERNARY]	LINECODE	[AMI]		
FRAME	[OFF]				
TX CLOCK SOURCE	[INTERNAL]				
PATTERN	[1111]				
ERROR ADD	[BIT]	[SINGLE]			
STATUS:	<input type="checkbox"/> 2 ¹⁵ -1	<input type="checkbox"/> 2 ¹¹ -1	<input type="checkbox"/> 1111	<input type="checkbox"/> 1010	<input type="checkbox"/> MORE

10. Ensure that the Frequency Counter reads between 352004.22 Hz and 351995.77 Hz.

8-12 Performance Tests

Mux & Demux Tests

Specifications

V.24 Data Access

Rate: 64 kbit/s

Mode: DCE

Connector: 25-pin D-type side panel

Demux: A single timeslot (at 64kbit/s) can be extracted from the received 2Mbit/s data and retransmitted on a V.24 interface.

Mux: A 64kbit/s data stream can be received at the V.24 interface and retransmitted in one timeslot of the transmitted 2 Mbit/s data.

Mux and demux can operate simultaneously.

Description

These tests verify -

- a) the HP 37722A's ability to take a 64 Kb/s signal applied to the Datacom (V.24) interface, via a loopback connection, and multiplex it up into a timeslot within the 2.048 Mb/s transmitted stream.
- b) the HP 37722A's ability to receive a 2.048 Mb/s stream and demultiplex a timeslot at 64 Kb/s down to the Datacom interface.

Equipment

Oscilloscope : HP 54201A/D
10:1 Divider Probe : HP 10435A
Loopback Connector : HP 5060-4462
75 Ω Termination : HP 15522-80010
T Connector

Mux & Demux Tests

Procedure

1. Ensure that there are no connections made to the front panel ports.
2. Recall the HP 37722A Default settings as shown on page 8-5.

Multiplexing

3. Connect the loopback connector to the DATACOM port - left side panel with instrument front panel facing you. Also, Connect the SIGNAL OUT port to the Oscilloscope INPUT 1, terminated in 75Ω (T Connector required).
4. Press HP 37722A **OTHER**, select **MISCELLANEOUS** (use **MORE** to bring up the MISCELLANEOUS field) and set the DESELECTED TIMESLOTS for ALL ONES.
5. Press HP 37722A **SETTINGS** and select the following:

Note: The APPLICATION is set for 2Mb/s EXTERNAL D & I.

APPLICATION	[2Mb/s EXTERNAL D&I]
INTERFACE [BINARY]	CLOCK-TX[↑], RX[↓]
FRAME (6.704)	[NO NFM]
THROUGH MODE	[OFF]
TX CLOCK SOURCE	[INTERNAL]
EXTERNAL DROP & INSERT	[DATACOM]
INSERT TO TIMESLOT [1]	[OFF]
DROP FROM TIMESLOT [1]	
SPEAKER / MICROPHONE	[OFF]
STATUS:	
CAS NFM	NO NFM
CAS_CRC4	CRC4 NFM

6. Configure the Oscilloscope as follows, then display Channel 1.

8-14 Performance Tests

Mux & Demux Tests

Status [Configuration]		Status: Waiting for Trigger	
		REM MTA	
Setup Label [REDACTED]			
Channel [Dual]	Input 1	Input 2	Timebase
Range	8.0 V	40 mV	Sampling @ 5.00 MHz
Offset	1.247 V	0.000 V	Mode [Single]
Probe	[1:1]	[1:1]	Range 200 μ s
Coupling	[dc] [1 Mn]	[dc] [1 Mn]	Acquire [Real Time]
Store Mode	[Envelope]	[Envelope]	Delay -20.000 μ s
Auto Scale	[Disabled]	[Disabled]	Reference [Left]
Label			Auto Scale [Disabled]
Trigger			
Mode [Analog Only]		* Refer to State Trigger Menus for Assignment and Sequence	
Analog Source	[Chan 1] [+ Slope]	Auto Scale	[Disabled]
Level	[Adjust] 1.500 V	On Event	00001
Probe	[1:1]	Coupling	[dc] [1 Mn]

7. Press the Oscilloscope RUN/STOP key to obtain waveform shown below:

Mux & Demux Tests

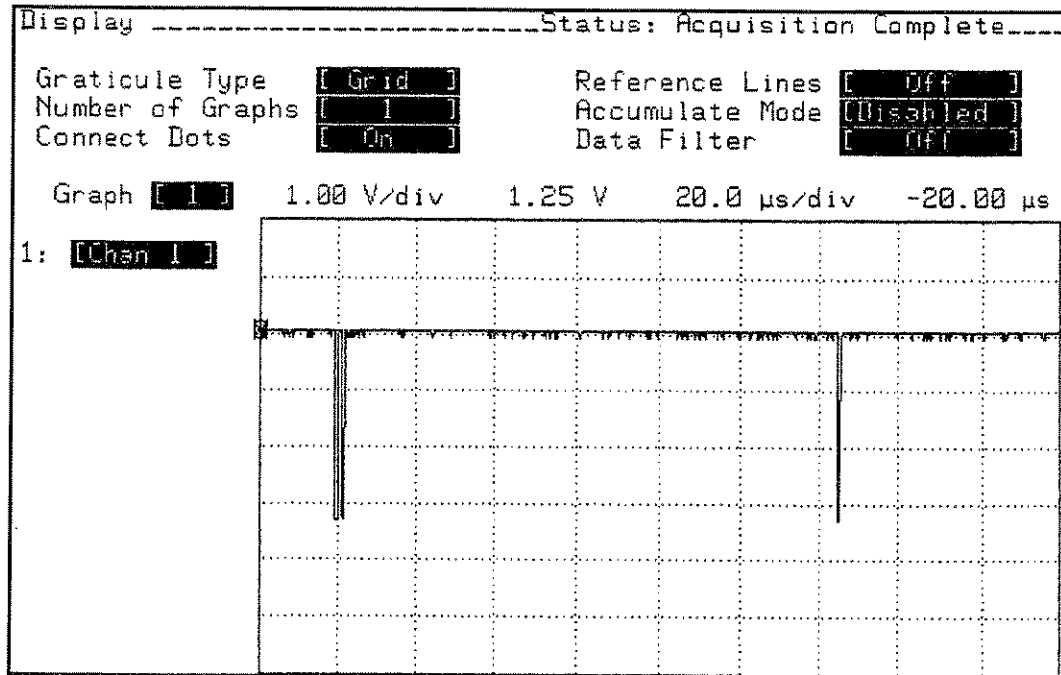

8. Set the displayed INSERT TO TIMESLOT fields for [01] [ON].

Mux & Demux Tests

9. Press the Oscilloscope RUN/STOP key and verify that the waveform shown below can be obtained:

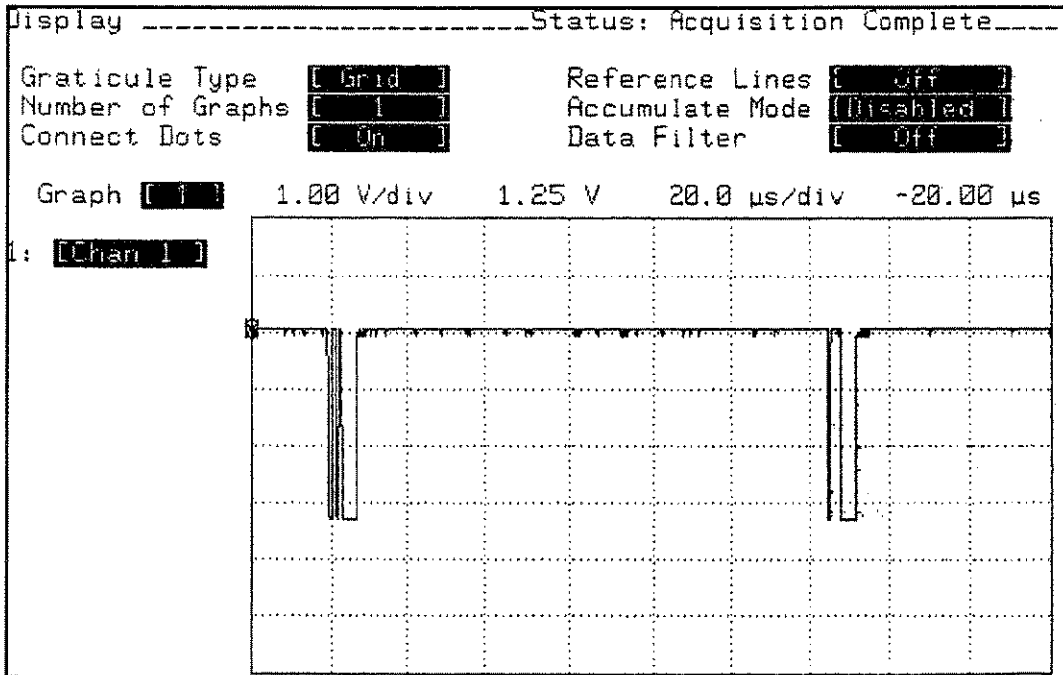

Mux & Demux Tests

Demultiplexing

10. Set the displayed INSERT TO TIMESLOT fields for [01] [OFF] and the DROP FROM TIMESLOT field for [11].
11. Connect the SIGNAL OUT 75Ω Unbalanced port to the SIGNAL IN 75Ω Unbalanced port and the CLOCK OUT port to the CLOCK IN port.
12. Press HP 37722A **OTHER** and set the DESELECTED TIMESLOTS field for 2^6-1 .
13. Configure the Oscilloscope as shown below, then display Channel 1.

Status [Configuration] -----Status: No Trigger Found-----	
REM MTA	
Setup Label [REDACTED]	
Channel [Dual]	Timebase
Input 1	Input 2
Range [40 V]	[40 mV]
Offset [0.000 V]	[0.000 V]
Probe [10:1]	[1:1]
Coupling [dc] [1 MΩ]	[dc] [1 MΩ]
Store Mode [Normal]	[Envelope]
Auto Scale [Disabled]	[Disabled]
Label	
Sampling @ 200 kHz	
Mode [Auto]	
Range [5.00 ms]	
Acquire [Real Time]	
Delay [-20.0000 μs]	
Reference [Left]	
Auto Scale [Disabled]	
Trigger	
* Refer to State Trigger Menus for Assignment and Sequence	
Mode [Analog Only]	
Analog Source [Chan 1]	[+ Slope]
Level [Adjust]	[500.0 mV]
Probe [10:1]	
Auto Scale [Disabled]	
On Event [0000]	
Coupling [dc] [1 MΩ]	

14. Remove the loopback connector from the DATACOM port and probe the Datacom port connector pin 3 with the Oscilloscope probe and verify that the following PRBS waveform can be obtained:

Mux & Demux Tests

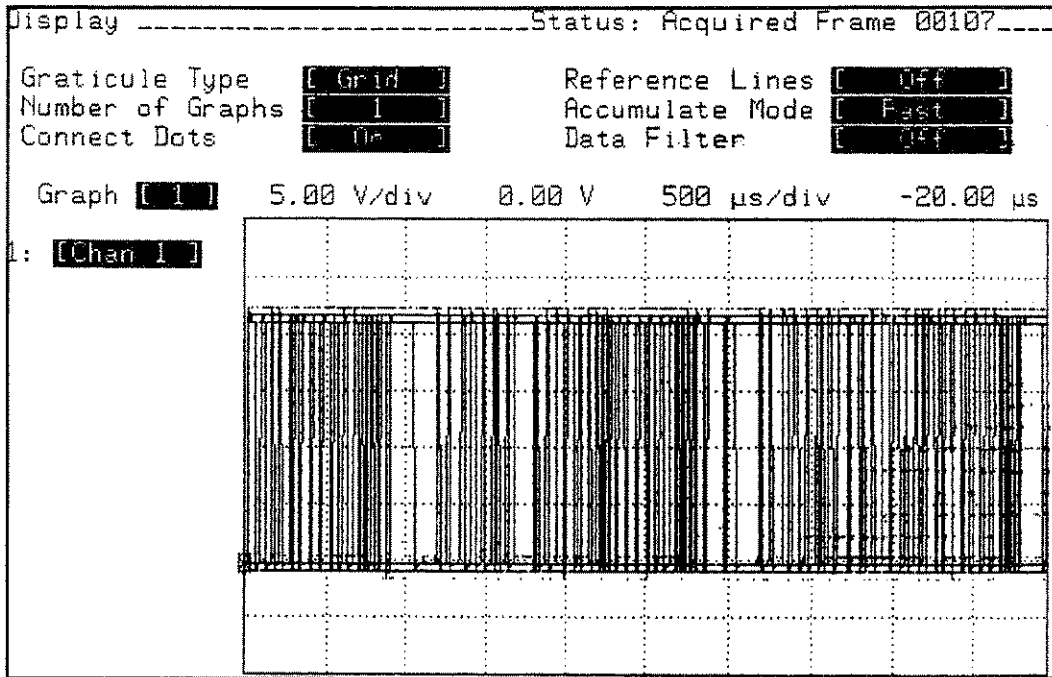

15. Set the displayed DESELECTED TIMESLOTS field for ALL ONES and verify that the following Oscilloscope waveform can be obtained. Note: an ALL ONES signal over the V.24 port is displayed as a negative 10 volt level:

Mux & Demux Tests

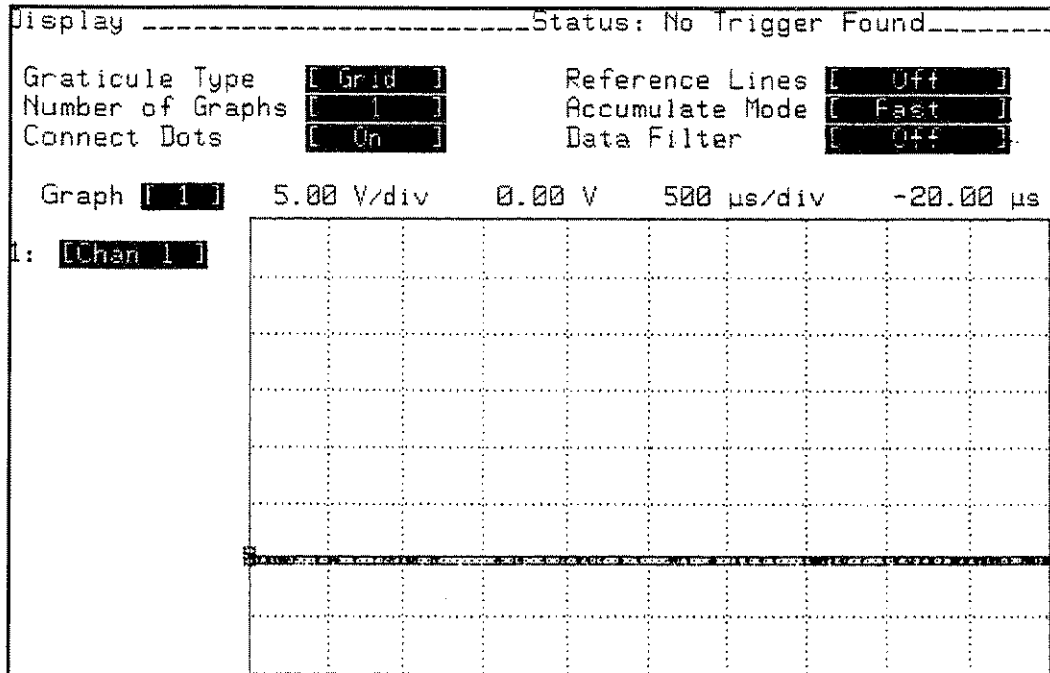

Mux & Demux Tests (Options 005/006 only)

Specifications

External X.21 data access to n unstructured 64 kbit/s timeslots within a 2 Mbit/s signal (n = 1 to 6)

Description

These tests verify:

- a) the HP 37722A's ability to take a 64 Kb/s signal applied to the Datacom (X.21) interface, via a loopback connection, and multiplex it up into a timeslot within the 2.048 Mb/s transmitted stream.
- b) the HP 37722A's ability to receive a 2.048 Mb/s stream and demultiplex a timeslot at 64 Kb/s down to the Datacom interface.

Equipment

Oscilloscope	: HP 54201A/D
10:1 Divider Probe	: HP 10435A
15 way X.21 Mating Connector	: HP 1251-5503
75Ω Termination	: HP 15522-80010
T Connector	

Procedure

1. Ensure that there are no connections made to the front panel ports.
2. Recall the HP 37722A Default settings as shown on page 8-5.

Multiplexing

3. Take the 15 way connector (1251-5503) and use wire links to connect pins 2 to 4 and 9 to 11 (see following figure). Connect the modified 15 way connector to the DATACOM port - left side panel with instrument front panel facing you. Also, Connect the SIGNAL OUT port to the Oscilloscope INPUT 1, terminated in 75Ω (T Connector required).

Mux & Demux Tests (Options 005/006 only)

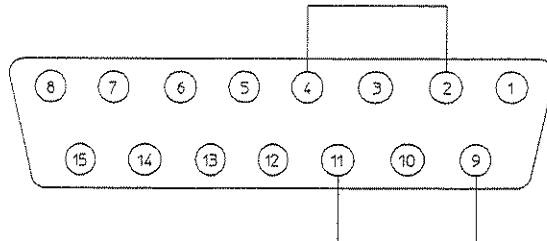

15 way connections on the pin side of HP 1251-5503

4. Press HP 37722A **OTHER**, select **MISCELLANEOUS** (use **MORE** to bring up the MISCELLANEOUS field) and set the DESELECTED TIMESLOTS for ALL ONES.
5. Press HP 37722A **SETTINGS** and select the following:
Note: The APPLICATION is set for 2Mb/s EXTERNAL D & I.

```
APPLICATION      [ 2Mb/s EXTERNAL D&I ]
-----
INTERFACE [ BINARY ] CLOCK-TX[↑], RX[↓]
FRAME (6.704) [ NO MFM ]
THROUGH MODE [ OFF ]
TX CLOCK SOURCE [ INTERNAL ]

EXTERNAL DROP & INSERT [ DATACOM ]
INSERT CONTROL [ OFF ]
DROP TIMESLOTS [ 8S PER INSERT ]
I- [ F#..... ]
      |-----|
      Bandwidth 64kb/s

STATUS:
[ 8S PER INSERT ] [ SELECT ]
```

6. Configure the Oscilloscope as follows, then display Channel 1.

8-22 Performance Tests

Mux & Demux Tests (Options 005/006 only)

```

Status [Configuration] -----Status: Waiting for Trigger-----
                                REM MTA
                                Setup Label [REDACTED]

Channel [Dual]
-----
Input 1      Input 2      Timebase
Range        8.0 V        40 mV        Sampling @ 5.00 MHz
Offset       1.247 V      0.000 V     Mode [Single]
Probe        [1:1]       [1:1]       Range [200 us]
Coupling     [dc] [1 MΩ] [dc] [1 MΩ] Acquire [Real Time]
Store Mode   [Envelope] [Envelope] Delay [20.0000 us]
Auto Scale   [Disabled] [Disabled] Reference [Left]
Label        [REDACTED] Auto Scale [Disabled]

Trigger
-----
Mode [Analog Only] * Refer to State Trigger Menus
                          for Assignment and Sequence

Analog Source [Chan 1] [+ Slope] Auto Scale [Disabled]
Level [Adjust] [1.500 V] On Event [0000]
Probe [1:1] Coupling [dc] [1 MΩ]
    
```

- Press the Oscilloscope RUN/STOP key to obtain waveform shown below. You may need to press RUN/STOP several times to display the pulses in the order shown in the following figure.

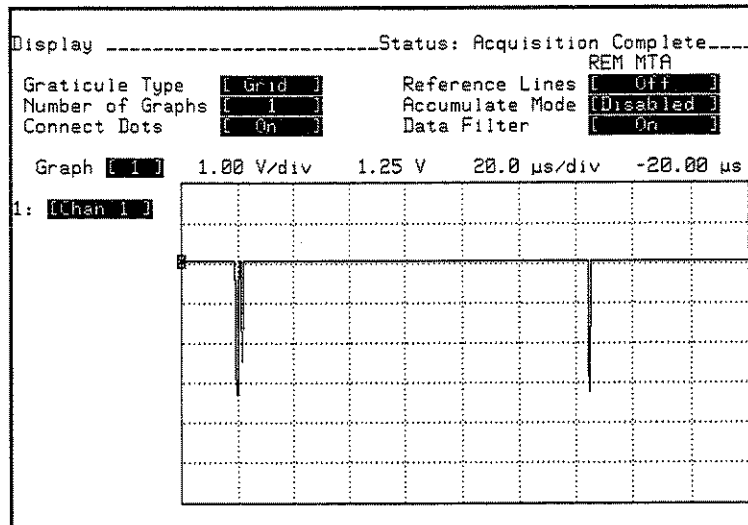

Mux & Demux Tests (Options 005/006 only)

- Set the displayed INSERT CONTROL field from [OFF] to [ON].
- Press the Oscilloscope RUN/STOP key and verify that the waveform shown below can be obtained:

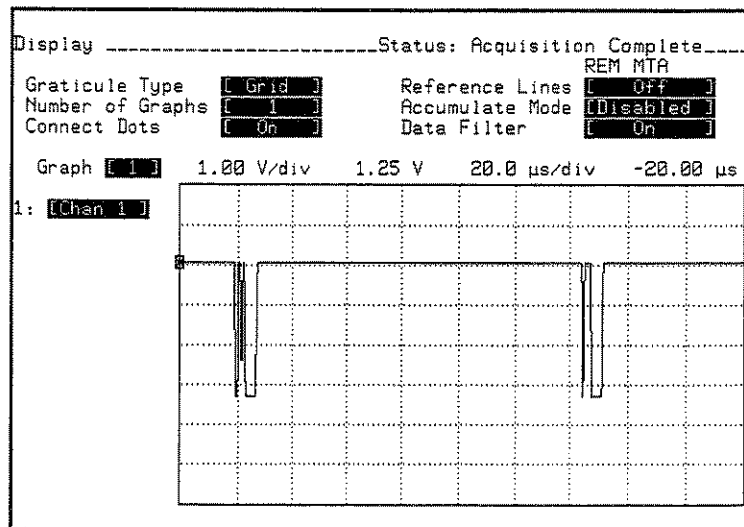

Demultiplexing

- Press HP 37722A **SETTINGS** and select the following:

```
APPLICATION      [ 2Mb/s EXTERNAL D&I ]
INTERFACE [ BINARY ] CLOCK-TX[↑], RX[↓]
FRAME (6.704)   [ NO MFM ]
THROUGH MODE    [ OFF ]
TX CLOCK SOURCE [ INTERNAL ]

EXTERNAL DROP & INSERT [ DATACOM ]
INSERT CONTROL   [ OFF ]
DROP TIMESLOTS  [ SELECT ]
I- [ F*..... ]
D- [ F.....* ]
Cursor On Timeslot #12
Bandwidth Tx 64kb/s Rx 64kb/s

STATUS:
DESELECT * DESELECT ALL ← →
```

8-24 Performance Tests

Mux & Demux Tests (Options 005/006 only)

11. Connect the SIGNAL OUT 75Ω Unbalanced port to the SIGNAL IN 75Ω Unbalanced port and the CLOCK OUT port to the CLOCK IN port.
12. Press HP 37722A **OTHER** and set the DESELECTED TIMESLOTS field for 2^6-1 .
13. Configure the Oscilloscope as shown below, then display Channel 1.

Status [Configuration]		Status: Acquisition Complete	
		REM MTA	
Setup Label: [REDACTED]			
Channel [Dual]		Timebase	
	Input 1	Input 2	Sampling @ 200 kHz
Range	10 V	40 mV	Mode [Auto]
Offset	0.000 V	0.000 V	Range 5.00 ms
Probe	[10:1]	[1:1]	Acquire [Real Time]
Coupling	[dc] [1 MΩ]	[dc] [1 MΩ]	Delay 20.0000 μs
Store Mode	[Normal]	[Envelope]	Reference [Left]
Auto Scale	[Disabled]	[Disabled]	Auto Scale [Disabled]
Label	[REDACTED]	[REDACTED]	
Trigger			
Mode [Analog Only]		* Refer to State Trigger Menus for Assignment and Sequence	
Analog Source	[Chan 1]	[+ Slope]	Auto Scale [Enabled]
Level	[Adjust]	500.0 mV	On Event 00001
Probe	[10:1]		Coupling [dc] [1 MΩ]

14. Remove the loopback connector from the DATACOM port and probe the Datacom port connector pin 4 with the Oscilloscope probe and verify that a PRBS waveform can be obtained. The following figure shows a typical waveform.

Mux & Demux Tests (Options 005/006 only)

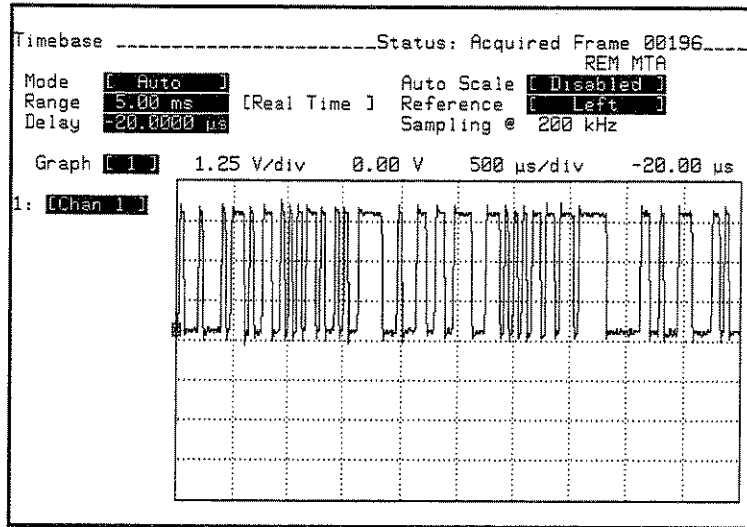

15. Set the displayed DESELECTED TIMESLOTS field for ALL ONES and verify that the Oscilloscope shows a 0V DC level. - note: an ALL ONES signal over the X.21 port is displayed as a 0 volt level:

External Drop and Insert (Options 005/006 only)

Specifications

Input

Connector: 3-pin Siemens on side panel

Impedance: 600 Ω balanced (nominal)

TLP: 0.0dB (nominal)

Output

Connector: 3-pin Siemens on side panel

Impedance: 600 Ω balanced (nominal)

TLP: 0.0dB (nominal)

Description

This test verifies that an externally applied analog signal can be coded, inserted into a framed structure timeslot, transmitted digitally from Tx to Rx then decoded back to an analog signal.

Equipment

Synthesizer : HP 3336A

Oscilloscope : HP 54201A/D

10 : 1 Divider Probe : HP 10435A

Procedure

1. Recall the HP 37722A Default settings as shown on page 8-5.
2. Set the Synthesizer to generate a 1000 Hz sinewave at 0 dBm Amplitude.
3. Equipment set up: Connect the Synthesizer 600 Ω output to the HP 37722A 600 Ω AUDIO I/P (side panel). Also, connect the SIGNAL OUT 75 Ω Unbalanced port to the SIGNAL IN 75 Ω Unbalanced port.
4. Press HP 37722A Settings and select the following:

```
APPLICATION [ 2Mb/s EXTERNAL D&I ]
-----
INTERFACE [ TERNARY ] LINECODE [ HDDB3 ]
FRAME (G.704) [ CAS MPH ]
THROUGH MODE [ OFF ]
TX CLOCK SOURCE [ INTERNAL ]

EXTERNAL DROP & INSERT [ 600Ω AUDIO ]
INSERT TO TIMESLOT [ 1 ] [ ON ]
DROP FROM TIMESLOT [ 1 ]

SPEAKER / MICROPHONE [ OFF ]

STATUS:
OFF ON
```

5. Connect the Oscilloscope 10:1 probe to the 600Ω AUDIO O/P center pin and verify that a 2.2V pk-pk (typically) sinewave with a period of 1.0ms is displayed.
6. Use the HP 37722A cursor keys to highlight the displayed SPEAKER/MICROPHONE field and select **ON**.
7. Press HP 37722A **VOL** to verify that the 1 KHz tone is audible from the loudspeaker. Vary the volume level using the **VOL** control keys to ensure that the tone can be increased and reduced to a point where no tone is audible from the loudspeaker.

Operation Verification Test Record, Telecom

Page No.	Test Description	Result		
		<i>Min</i>	<i>Actual</i>	<i>Max</i>
	<i>Telecom Analyzer Self Test</i>			
8-8	Step 6: "TEST STATUS PASSED" displayed.			
8-8	Step 9: "SIGNAL PRESENT" LED on.			
	<i>Internal Transmitter Clocks</i>			
8-11	Step 4: Frequency Counter reading.	1023987.7Hz		1024012.3Hz
8-11	Step 6: Frequency Counter reading.	31999.6161Hz		32000.384Hz
8-12	Step 8: Frequency Counter reading.	4223949.3Hz		4224050.7Hz
8-12	Step 10: Frequency Counter reading.	351995.77Hz		352004.22Hz
	<i>Mux & Demux</i>			
8-17	Step 9: Waveform correct.			
8-19	Step 14: PRBS waveform correct.			
8-20	Step 15: ALL ONES waveform correct.			
	<i>Mux & Demux (Options 005/006)</i>			
8-23	Step 7: Waveform correct.			
8-24	Step 9: Waveform correct.			
8-25	Step 14: Waveform correct.			
8-26	Step 15: 0 V displayed.			
	<i>External Drop and Insert (Options 005/006)</i>			
8-30	Step 5: waveform correct.			
	Step 7: volume varies			

Performance Tests, Telecom



Self Test

Description

These tests give a high degree of confidence that the HP 37722A is operating to its warranted specification. A description of each test is given on page 8-35.

Equipment

RS-232 Loopback Connector : HP 5060-4462

15 Way Connector (X.21) : HP 1251-5503 (required for instruments with Option 005)

Procedure

1. Connect the HP 37722A SIGNAL OUT 75 Ω Unbalanced port to the SIGNAL IN 75 Ω Unbalanced port (front panel).
2. Connect the CLOCK OUT port to the CLOCK IN port.
3. Connect the RS-232 loopback connector to the RS-232 port (right hand side panel of the instrument). Alternatively use wire links to either modify an RS-232 connector or connect across the RS-232 port as shown below.

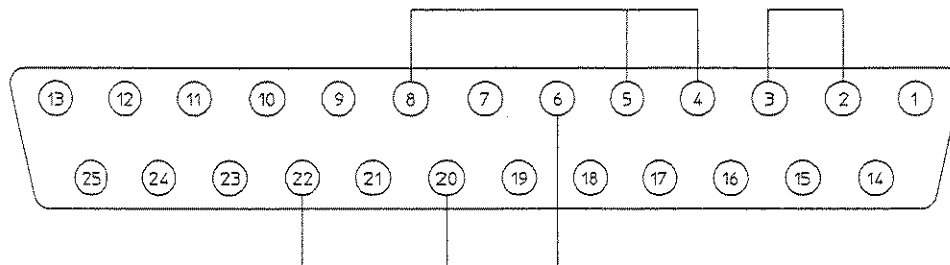

RS-232 Connections

4. **Option 005 only.** Take the 15 way connector (1251-5503) and use wire links to connect pins 2 to 4 and 9 to 11 (see the following figure). Connect the modified 15 way connector to the DATACOM connector (left side of instrument), this gives the required X.21 loopback.

Self Test

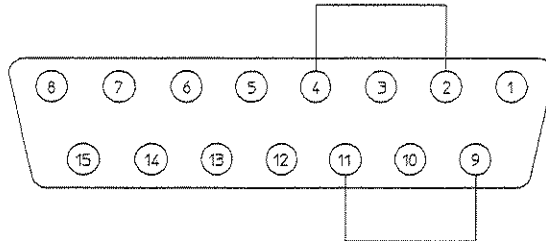

15 way connections on the pin side of HP 1251-5503

5. Press HP 37722A **OTHER**, select **SELF TEST** (use **MORE** to bring up the SELF TEST field) and set the TEST TYPE for ALL TESTS.
6. Press HP 37722A **START/STOP** and verify that "TEST STATUS PASSED" is displayed at the end of ALL TESTS, approximately 12 minutes.
7. Disconnect the HP 37722A cables from the front panel connectors.
8. Connect the SIGNAL OUT Siemens 3-pin 120 Ω Balanced port to the SIGNAL IN Siemens 3-pin 120 Ω Balanced port (front panel).
9. Verify that the SIGNAL PRESENT front panel status led is the only led on (the HISTORY led may be on due to previous signal conditions).

Note



If a self test fails each test can be run individually to discover the extent of the instrument malfunction. Refer to the service manual Troubleshooting to find out how to correct this failure.

Telecom Self Tests, Order and Fail Codes

When ALL TESTS is selected the individual tests (1 to 12) are performed in the order shown in the following table. Test 1 is a general test of the Control Processor Unit (CPU). Tests 2 to 11 use a comparison of measured results and expected results. The measurements are made on signals which are externally looped back from transmitter to receiver. Test 12 verifies Option 005 operation. If a test failure occurs, the failure code displayed indicates the part of the individual test which has failed. The test which failed is indicated by the group of failure codes shown in the following table. A more detailed list of fail codes is given in the service documentation.

Fail Code Group	Test	Test Number
1 to 1099	CPU	1
2000 to 2999	Pattern	2
3000 to 3999	Frame	3
4000 to 4999	Line Code	4
5000 to 5999	Timeslot	5
6000 to 6999	Error Add	6
7000 to 7999	Frame Error	7
8000 to 8999	Alarms	8
9000 to 9999	Signal	9
10000 to 10999	Bit	10
11000 to 11999	Clock Recovery	11
12000 to 12999	Sub Rate	12

Internal Transmitter Clocks

Specifications

Frequency: 2.048 MHz

Stability: ± 10 ppm temperature 0 - 50 C

Ageing : ± 2 ppm per year (typical)

Frequency: 64 kHz.

Stability: ± 10 ppm temperature 0 - 50 C.

Ageing: ± 2 ppm per year typical

Frequency: 8.448 MHz (Option 002)

Stability and ageing: as for 2 Mbit/s transmitter

Frequency: 704 kHz (Option 003)

Stability: ± 10 ppm temperature 0 - 50 C.

Ageing: ± 2 ppm per year typical

Description

This test verifies that the transmit data rates are within 12PPM with the provision that the instrument has been through it's yearly calibration cycle.

Note: The Frequency Counter triggers off of the positive pulses only, this results in a frequency count of half the selected data rate.

Equipment

Frequency Counter : HP 5316B Option 001

75 Ohm Termination : HP 15522-80010

T Connector

Procedure

1. Recall the HP 37722A DEFAULT SETTINGS as shown on page 8-5.
2. Connect the HP 37722A SIGNAL OUT 75 Ω Unbalanced port to the Frequency Counter. Terminate the Frequency Counter input in 75 Ω (use the T Connector).

8-34 Performance Tests

Internal Transmitter Clocks

2.048 MHz

3. Press HP 37722A **SETTINGS** and select the following:

APPLICATION	[2Mb/s]			
INTERFACE [TERNARY]	LINECODE [AMI]			
FRAME (6.704)	[OFF]			
TX CLOCK SOURCE	[INTERNAL]			
PATTERN	[1111]			
ERROR ADD [BIT]	[SINGLE]			
STATUS:				
2Mb/s	704kb/s	8Mb/s	64kb/s	NONE

4. Ensure that the Frequency Counter reads between 1024012.3 Hz and 1023987.7 Hz.

64 KHz

5. Press HP 37722A **SETTINGS** and select the following:

APPLICATION	[64kb/s]			
INTERFACE	[CODIRECTIONAL]			
TX CLOCK SOURCE	[INTERNAL]			
CODIR OCTET TIMING	[OFF]			
PATTERN	[1111]			
ERROR ADD (BIT)	[SINGLE]			
STATUS:				
2 ²⁸ -1	2 ¹⁵ -1	2 ¹¹ -1	1111	NONE

6. Ensure that the Frequency Counter reads between 32000.384 Hz and 31999.616 Hz.

Internal Transmitter Clocks

8.448 MHz (Option 002 only)

7. Press HP 37722A **SETTINGS** and select the following:

APPLICATION	[8Mb/s]				
INTERFACE	(TERNARY)	LINECODE	(HDDBS)		
PATTERN	[1111]				
ERROR ADD	[BIT]	[SINGLE]			
STATUS:	2 ²⁸ -1	2 ¹⁸ -1	2 ¹¹ -1	1111	MORE

8. Ensure that the Frequency Counter reads between 4224050.7 Hz and 4223949.3 Hz.

704 KHz (Option 003 only)

9. Press HP 37722A **SETTINGS** and select the following:

APPLICATION	[704kb/s]				
INTERFACE	[TERNARY]	LINECODE	[AMI]		
FRAME	[OFF]				
TX CLOCK SOURCE	[INTERNAL]				
PATTERN	[1111]				
ERROR ADD	[BIT]	[SINGLE]			
STATUS:	2 ¹⁸ -1	2 ¹¹ -1	1111	1010	MORE

10. Ensure that the Frequency Counter reads between 352004.22 Hz and 351995.77 Hz.

8-36 Performance Tests

External Transmitter Clock

Specifications

External Tx Clock: Frequency: 500 kHz to 9 MHz.

Impedance, Format and Threshold: as for 704 k,
2 Mbit/s and 8 Mbit/s receiver binary clock input.

Description

This test verifies that the transmit data rates can be clocked from an external source. A Synthesizer/Function Generator is used to provide the external clock at the front panel CLOCK IN port.

Equipment

Function Generator : HP 3325B

Procedure

1. Recall the HP 37722A DEFAULT SETTINGS as shown on page 8-5.

External Transmitter Clock

2. Press HP 37722A **SETTINGS** and select the following:

APPLICATION	[2Mb/s]
INTERFACE [BINARY]	CLOCK-TX[↑], RX[↓]
FRAME (G.704)	[OFF]
TX CLOCK SOURCE	[EXTERNAL]
PATTERN	[1111]
ERROR ADD (BIT) [SINGLE]	
STATUS:	2 ¹⁸ -1 2 ¹⁹ -1 2 ¹¹ -1 1111 MORE

3. Set the Function Generator as follows:

Main Function : Squarewave
Frequency : 2.048 MHz
Amplitude : 2 Volts Pk-Pk
DC Offset : +1 Volt

4. Connect the SIGNAL OUT 75Ω port to the SIGNAL IN 75Ω port and note that the display status line shows External Clock Loss and that the STATUS leds show SIGNAL LOSS.
5. Connect the Function Generator to the HP 37722A CLOCK IN 75Ω port.
6. Verify that the previously displayed External Clock Loss no longer appears and that the Status Leds show SIGNAL PRESENT and AIS.
7. Set the Function Generator frequency to 500 kHz and repeat step 6.
8. Set the Function Generator frequency to 9 MHz and repeat step 6.
9. Disconnect the Function Generator from the CLOCK IN port.

External Transmitter Clock

64 KHz

10. Press HP 37722A **SETTINGS** and select the following:

APPLICATION	[64kb/s]
INTERFACE	(CODIRECTIONAL)
TX CLOCK SOURCE	[EXTERNAL]
CODIR OCTET TIMING	[ON]
PATTERN	[1111]
ERROR ADD	(BIT) [SINGLE]
STATUS:	2 23-1 2 19-1 2 11-1 1111 MORE

11. Set the Function Generator as follows:

Main Function : Squarewave
Frequency : 256 KHz
Amplitude : 2 Volts Pk-Pk
DC Offset : +1 Volt

12. Note that the display status line shows External Clock Loss and that the STATUS leds show SIGNAL LOSS.
13. Connect the Function Generator to the HP 37722A CLOCK IN 75Ω port.
14. Verify that the previously displayed External Clock Loss no longer appears and that the Status Leds show SIGNAL PRESENT and AIS.
15. Set the Function Generator frequency to 256,051.2Hz and repeat step 14.
16. Set the Function Generator frequency to 255,848.8Hz and repeat step 14.
17. Disconnect the Function Generator from the HP 37722A CLOCK IN port.

Transmitter Output

Specifications

2 Mbit/s Transmitter

Interface characteristics meet CCITT Rec. G.703

Ternary Data Output

Impedance: 120 Ω balanced or 75 Ω unbalanced (nominal)

Pulse Shape: Conforming to CCITT Rec. G.703 table 6

64 kbit/s Transmitter

Interface: G.703 co-directional

Data Output

Impedance: 120 Ω balanced (nominal)

Pulse Shape: Conforming to CCITT Rec. G.703 Table 1

Option 002 - 8 Mbit/s

Ternary Data Output

Impedance: 75 Ω unbalanced (nominal).

Pulse Shape: typically conforming to CCITT G. 703 table 7.

Option 003 - 704kbit/s

Ternary Data Output

Impedance: 120 Ω balanced or 75 Ω unbalanced (nominal).

Pulse Amplitude: 2.37 V \pm 2.37 V (unbalanced), 3 V \pm 3 V (balanced)

Pulse Width: 710 ns \pm 71 ns

Pulse Overshoot: \leq 0.47 V

Pulse Undershoot: \leq 0.47 V

Transmitter Output

Description

This test verifies the transmitter output level and pulse shape for all rates. Note: the Balanced to Unbalanced Converter is used to test the balanced output port. The 3V peak at the output is reduced to 2.37V peak on the oscilloscope by the Balanced to Unbalanced Converter. Ensure that the oscilloscope is terminated in 75Ω.

Equipment

Oscilloscope	: HP 54201A/D (or 1700 series)
120/75Ω Balanced to Unbalanced Converter	: HP 15508C
Dual BNC to Siemens 3-pin	: see Step 16
75Ω Termination	: HP 15522-80010
Thinkjet Printer	: HP 2225A
T Connector	

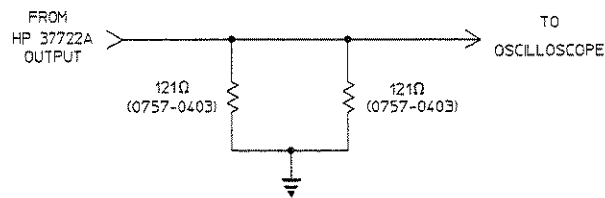

60Ω Termination Network

Procedure

1. Recall the HP 37722A DEFAULT SETTINGS as shown on page 8-5.
2.048 MB/s Balanced OUT port
2. Connect the SIGNAL OUT 120Ω Balanced port to the Oscilloscope INPUT 1 via the Balanced to Unbalanced Converter. Terminate the Oscilloscope in 75Ω (use the T Connector).
3. Connect the Thinkjet printer, set to LISTEN ALWAYS, to the Oscilloscope via HP-IB.
4. Press HP 37722A **SETTINGS** and select the following.

Transmitter Output

APPLICATION	[2Mb/s]
INTERFACE [TERNARY]	LINECODE [AMI]
FRAME (G.704)	[OFF]
TX CLOCK SOURCE	[INTERNAL]
PATTERN	[16 BIT WORD] [1000000010000000]
ERROR ADD	[BIT] [SINGLE]
STATUS:	
SET	0
SET	1
	←
	→

- Configure the Oscilloscope as follows, then display Channel 1.

Status [Configuration]	-----	Status: Waiting for Trigger
		REM MTA
		Setup Label []
Channel [Dual]		Timebase
Input 1	Input 2	Sampling @ 200 MHz
Range [8.0 V]	[400 mV]	Mode [Trig'd]
Offset [0.000 V]	[0.000 V]	Range [1.00 μs]
Probe [1:1]	[10:1]	Acquire [Real Time]
Coupling [dc] [1 MΩ]	[dc] [1 MΩ]	Delay [-385.000 ns]
Store Mode [Ave] [256]	[Normal]	Reference [Left]
Auto Scale [Disabled]	[Enabled]	Auto Scale [Disabled]
Label		
Trigger		* Refer to State Trigger Menu for Assignment and Sequence
Mode [Analog Only]		
Analog Source [Chan 1]	[+ Slope]	Auto Scale [Disabled]
Level [Adjust]	[1.000 V]	On Event [0000]
Probe [1:1]		Coupling [dc] [1 MΩ]

- Adjust the Oscilloscope Delay to position the positive peak pulse amplitude at mid-pulse-width point in the centre of the screen.
- Measure the peak pulse amplitude at mid-pulse-width using the Oscilloscope and verify that this is between 2.133V and 2.607V.

8-42 Performance Tests

Transmitter Output

8. Measure the pulse width at half the pulse amplitude and verify that this is between 219ns and 269ns.
9. Set the Oscilloscope SYSTEM to Peripherals and set for TALK ONLY and PRINTER.
10. Use the Oscilloscope HARDCOPY function to obtain a printout of the displayed pulse.
11. Place the 2.048 MB/s mask, shown below, over the pulse and ensure that the pulse falls within the mask (a transparent copy of the mask should be used). Note: the Oscilloscope gain (Range) may have to be adjusted to ensure that the pulse can be brought within the mask outline. If adjusted, return the gain (Range) to 8V once the step is completed.
12. Adjust the Oscilloscope Delay to position the negative pulse at mid-pulse-width point in the centre of the screen.
13. Repeat steps 7 to 11 for the negative pulse.

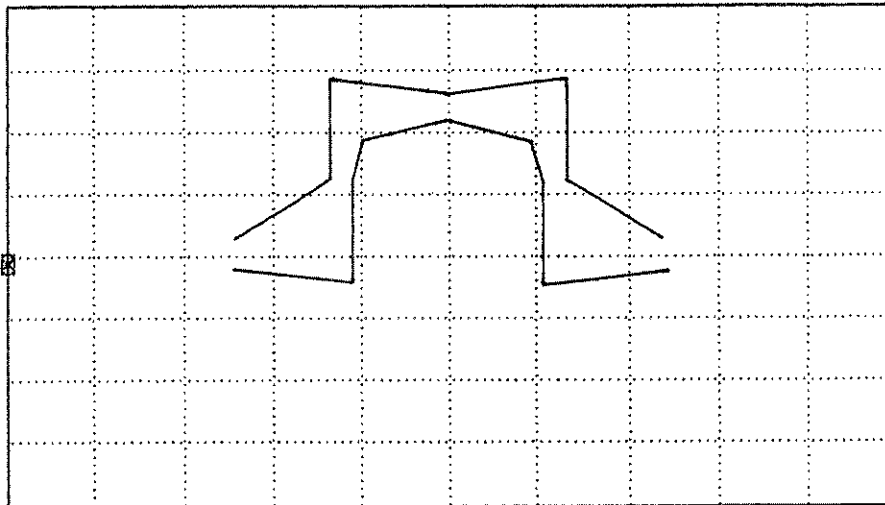

Transmitter Output

2.048 MB/s Unbalanced OUT port

14. Remove the Balanced to Unbalanced Converter from the Oscilloscope, leaving the 75Ω termination in place, and connect the SIGNAL OUT 75Ω Unbalanced port directly to Oscilloscope Input 1.
15. Repeat steps 6 to 13.

64 Kb/s Balanced OUT port

16. Connect the equipment as follows using the Dual BNC to Siemens 3 pin cable (see equipment list for 60Ω termination network).

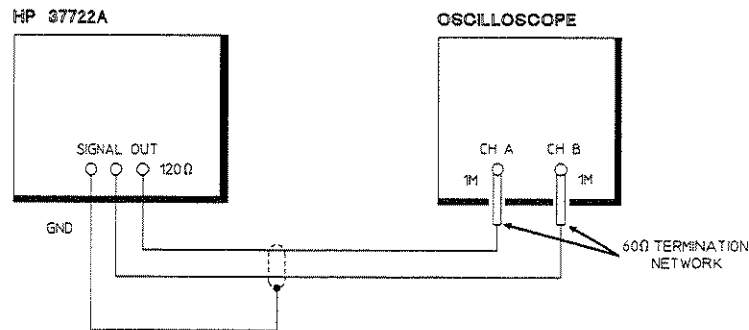

17. Press HP 37722A **SETTINGS** and select the following:

APPLICATION	[64kb/s]
INTERFACE	(CODIRECTIONAL)
TX CLOCK SOURCE	[INTERNAL]
CODIR OCTET TIMING	[OFF]
PATTERN	[16 BIT WORD]
	[0000000000000000]
ERROR ADD	(BIT) [SINGLE]
STATUS:	
SET	SET
0	1

← →

Transmitter Output

18. Configure the Oscilloscope as follows, then display Channel 1-2:

Status [Configuration]		Status: No Trigger Found	
		REM MTA	
Setup Label [REDACTED]			
Channel [1-2]		Timebase	
Range	2.0 V	Input 1-2	4.0 V
Offset	0.000 V		0.000 V
Probe	[1:1]	[1:1]	[1 Mn]
Coupling	[dc] [1 Mn]	[dc] [1 Mn]	
Store Mode	[Ave] [256]	[Normal]	
Auto Scale	[Disabled]	[Disabled]	
Label			
		Sampling @	100 MHz
		Mode	[Auto]
		Range	10.0 us
		Acquire	[Real Time]
		Delay	-3.00000 us
		Reference	[Left]
		Auto Scale	[Disabled]
Trigger			
Mode [Analog Only]		* Refer to State Trigger Menus for Assignment and Sequence	
Analog Source	[Chen 1]	[+ Slope]	Auto Scale [Disabled]
Level	[Adjust]	304.2 mV	On Event 00001
Probe	[1:1]		Coupling [dc] [1 Mn]

19. Adjust the Oscilloscope Delay to position the positive peak pulse amplitude at mid-pulse-width point in the centre of the screen.
20. Measure the peak pulse amplitude at mid-pulse-width using the Oscilloscope and verify that this is between 0.9V and 1.1V.
21. Measure the pulse width at half the pulse amplitude and verify that this is between 3.51us and 4.29us.
22. Use the Oscilloscope HARDCOPY function to obtain a printout of the displayed pulse.
23. Place the 64KB/s mask, shown below, over the pulse and ensure that the pulse falls within the mask (a transparent copy of the mask should be used). Note: the Oscilloscope gain (Range) may have to be adjusted to ensure that the pulse can be brought within the mask outline. If adjusted, return the gain (Range) to 2V once the step is completed.
24. Adjust the Oscilloscope Delay to position the negative pulse at mid-pulse-width point in the centre of the screen.

Transmitter Output

25. Repeat steps 20 to 23 for the negative pulse.

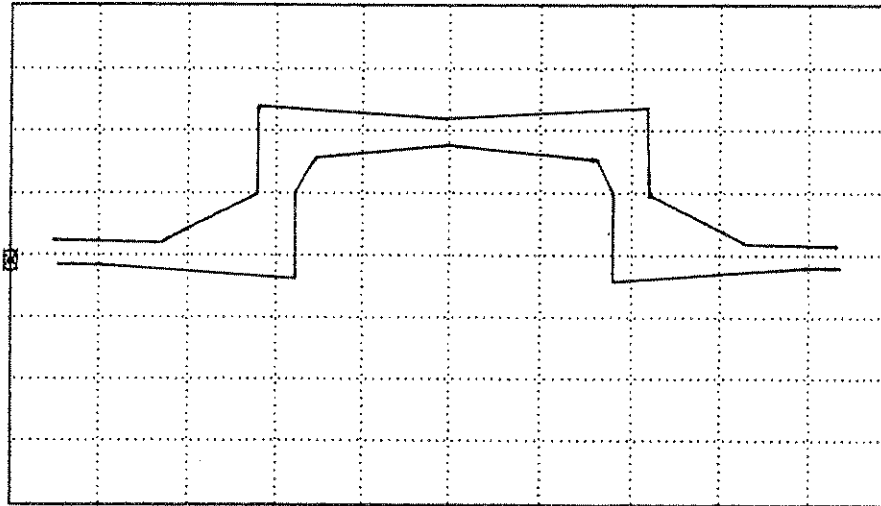

8 MB/s Unbalanced port - Option 002 only

26. Connect the SIGNAL OUT 75 Ω Unbalanced port to the Oscilloscope INPUT 1. Terminate the Oscilloscope in 75 Ω (use the T Connector).
27. Press HP 37722A **SETTINGS** and select the following.

APPLICATION	[8Mb/s]
INTERFACE	(TERNARY)
LINECODE	(HDB3)
PATTERN	[16 BIT WORD]
	[000100010001000]
ERROR ADD	[BIT] [SINGLE]
STATUS:	
SET	0
SET	1
	← →

Transmitter Output

28. Configure the Oscilloscope as follows, then display Channel 1.

Status	[Configuration]	-----Status: No Trigger Found-----	
		REM MTA	
	Setup Label	██████████	
Channel	[Dual]	Timebase	
	Input 1	Input 2	Sampling @ 200 MHz
Range	8.0 V	8.0 V	Mode [Auto]
Offset	0.000 V	0.000 V	Range 200 ns
Probe	[1:1]	[1:1]	Acquire [Real Time]
Coupling	[dc] [1 M Ω]	[dc] [1 M Ω]	Delay 72.4000 ns
Store Mode	[Ave] [256]	[Normal]	Reference [Left]
Auto Scale	[Disabled]	[Disabled]	Auto Scale [Disabled]
Label	██████████	██████████	
Trigger			* Refer to State Trigger Menus for Assignment and Sequence
Mode	[Analog Only]		
Analog Source	[Chan 1]	[+ Slope]	Auto Scale [Disabled]
Level	[Adjust]	1.000 V	On Event 00001
Probe	[1:1]		Coupling [dc] [1 M Ω]

29. Adjust the Oscilloscope Delay to position the positive peak pulse amplitude at mid-pulse-width point in the centre of the screen.
30. Measure the peak pulse amplitude at mid-pulse-width using the Oscilloscope and verify that this is between 2.133V and 2.607V.
31. Measure the pulse width at half the pulse amplitude and verify that this is between 49ns and 69ns.
32. Use the Oscilloscope HARDCOPY function to obtain a printout of the displayed pulse.
33. Place the 8.448 MB/s mask, shown below, over the pulse and ensure that the pulse falls within the mask (a transparent copy of the mask should be used). Note: the Oscilloscope gain (Range) may have to be adjusted to ensure that the pulse can be brought within the mask outline. If adjusted, return the gain (Range) to 8V once the step is completed.
34. Adjust the Oscilloscope Delay to position the negative pulse at mid-pulse-width point in the centre of the screen.

Transmitter Output

35. Repeat steps 30 to 33 for the negative pulse.

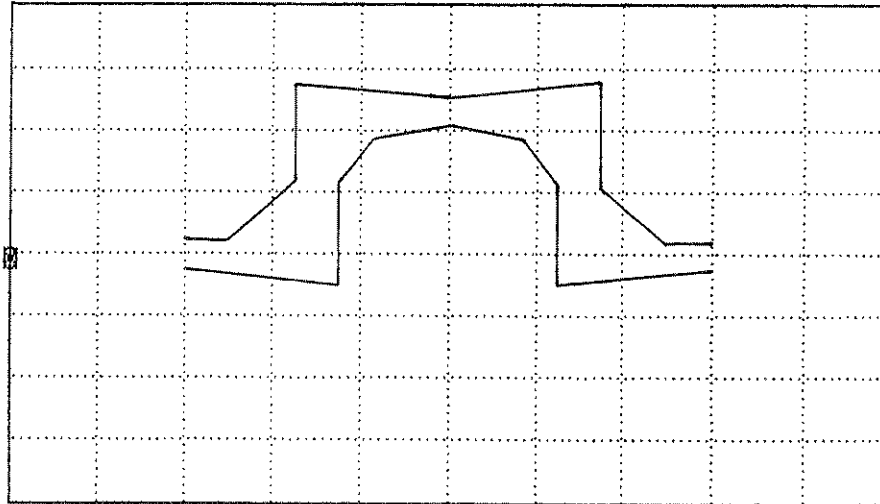

704KB/s Balanced OUT port - Option 003 only

36. Connect the SIGNAL OUT 120Ω Balanced port to the Oscilloscope INPUT 1 via the Balanced to Unbalanced Converter. Terminate the Oscilloscope in 75Ω (use the T Connector).
37. Press HP 37722A **SETTINGS** and select the following.

APPLICATION	[704kb/s]
INTERFACE [TERNARY]	LINECODE [AMI]
FRAME [OFF]	
TX CLOCK SOURCE [INTERNAL]	
PATTERN [16 BIT WORD]	[1000000010000000]
ERROR ADD [BIT]	[SINGLE]
STATUS:	
SET 0	SET 1
←	→

Transmitter Output

38. Configure the Oscilloscope as follows, then display Channel 1.

Status [Configuration]		Status: No Trigger Found	
		REM MTA	
Setup Label			
Channel [Dual]	Input 1	Input 2	Timebase
Range	8.0 V	8.0 V	Sampling @ 200 MHz
Offset	0.000 V	0.000 V	Mode [Auto]
Probe	[1:1]	[1:1]	Range 2.00 μ s
Coupling	[dc] [1 M Ω]	[dc] [1 M Ω]	Acquire [Real time]
Store Mode	[Ave] [256]	[Normal]	Delay -648.000 ns
Auto Scale	[Disabled]	[Disabled]	Reference [Left]
Label			Auto Scale [Disabled]
Trigger			
Mode [Analog Only]		* Refer to State Trigger Menus for Assignment and Sequence	
Analog Source	[Chan 1]	[+ Slope]	Auto Scale [Disabled]
Level	[Adjust]	1.000 V	On Event 00001
Probe	[1:1]		Coupling [dc] [1 M Ω]

39. Adjust the Oscilloscope Delay to position the positive peak pulse amplitude at mid-pulse-width point in the centre of the screen.

40. Verify that the pulse has the following characteristics:

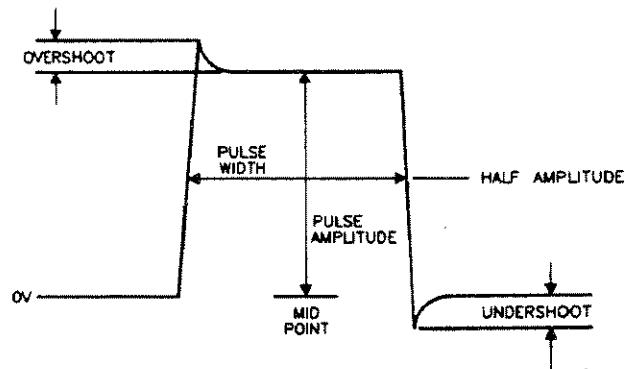

Transmitter Output

Pulse Amplitude : $2.37V \pm 0.237V$
Pulse Width : $710ns \pm 71ns$
Overshoot : $\leq 0.474V$
Undershoot : $\leq 0.474V$

41. Adjust the Oscilloscope Delay to position the negative pulse in the centre of the screen and verify that the pulse characteristics are as outlined in step 40.

704 KB/s Unbalanced OUT port - Option 003 only

42. Remove the Balanced to Unbalanced Converter from the Oscilloscope, leaving the 75Ω termination in place, and connect the SIGNAL OUT 75Ω Unbalanced port directly to Oscilloscope Input 1.
43. Repeat steps 39 to 41.

Binary Data and Clock Outputs

Specifications

2 Mbit/s Transmitter

Binary Data Output

Impedance: 75 Ω unbalanced (nominal)

Format: NRZ Binary

Amplitude: Mark > 3.0 Volts

Space < 0.5 Volts

Binary Clock Output

Impedance: 75 Ω unbalanced (nominal)

Format: Square wave, 50 \pm 6 % duty cycle on internal clock

Amplitude: Mark > 3.0 Volts

Space < 0.5 Volts.

Polarity: Normal or Inverted

704 kBit/s Transmitter

Binary Data Output

Impedance: 75 Ω unbalanced (nominal)

Format: NRZ Binary

Amplitude: Mark > 3.0 Volts

Space: < 0.5 Volts.

Binary Clock Output

Impedance: 75 Ω unbalanced (nominal)

Format: Square wave, 50 \pm 6 % duty cycle on internal clock

Amplitude: Mark > 3.0 Volts, Space < 0.5 Volts

Polarity: Normal or Inverted.

Binary Data and Clock Outputs

8 Mbit/s Transmitter

Binary Data Output

Impedance: 75 Ω unbalanced (nominal)

Format: NRZ Binary

Amplitude: Mark > 3.0 Volts
Space < 0.5 Volts

Binary Clock Output

Impedance: 75 Ω unbalanced (nominal)

Format: Square wave (nominal)

Amplitude: Mark > 3.0 Volts
Space < 0.5 Volts.

Polarity: Normal or Inverted

Description

The Binary Data and Clock outputs for 2MB/s and 704 KB/s are verified using an Oscilloscope.

Equipment

Oscilloscope : HP 54201A/D
75 Ω Termination (2) : HP 15522-80010
T Connectors (2)

Procedure

2 MB/s Data & Clock O/P

1. Recall the HP 37722A DEFAULT SETTINGS as shown on page 8-5.
2. Connect the SIGNAL OUT 75 Ω Unbalanced port to Oscilloscope INPUT 1, terminated in 75 Ω (T Connector required) and the CLOCK OUT port to the Oscilloscope INPUT 2, terminated in 75 Ω (T Connector required).
3. Press HP 37722A **SETTINGS** and select the following:

Binary Data and Clock Outputs

APPLICATION	[2Mb/s]
INTERFACE	[BINARY] CLOCK-TX[↑], RX[↓]
FRAME (6.704)	[OFF]
TX CLOCK SOURCE	[INTERNAL]
PATTERN	[1010]
ERROR ADD (BIT)	[SINGLE]
STATUS:	
1010	16 BIT WORD
LIVE DATA	MORE

4. Configure the Oscilloscope as follows, then display both channels.

Status	[Configuration]	-----	Status: No Trigger Found
			REM MTA
		Setup Label	[]
Channel	[Dual]	Timebase	
	Input 1 Input 2	Sampling @	200 MHz
Range	8.0 V 8.0 V	Mode	[Auto]
Offset	0.000 V 0.000 V	Range	2.00 μ s
Probe	[1:1] [1:1]	Acquire	[Peak Time]
Coupling	[dc] [1 M Ω] [dc] [1 M Ω]	Delay	0.00000 s
Store Mode	[Normal] [Normal]	Reference	[Left]
Auto Scale	[Disabled] [Disabled]	Auto Scale	[Disabled]
Label	[] []		
Trigger			
Mode	[Analog Only]	* Refer to State Trigger Menus for Assignment and Sequence	
Analog Source	[Chan 1] [+ Slope]	Auto Scale	[Disabled]
Level	[Adjust] 1.000 V	On Event	[0000]
Probe	[1:1]	Coupling	[dc] [1 M Ω]

5. Ensure that the following waveforms can be obtained and that their associated parameters below are met:

Binary Data and Clock Outputs

INPUT 1 Parameters	INPUT 2 Parameters
Mark: >3Volt	Mark:>3Volt
Space: <0.5Volt	Space: <0.5Volt
	Duty: 50% ± 6%
	Period: 488ns (typically)

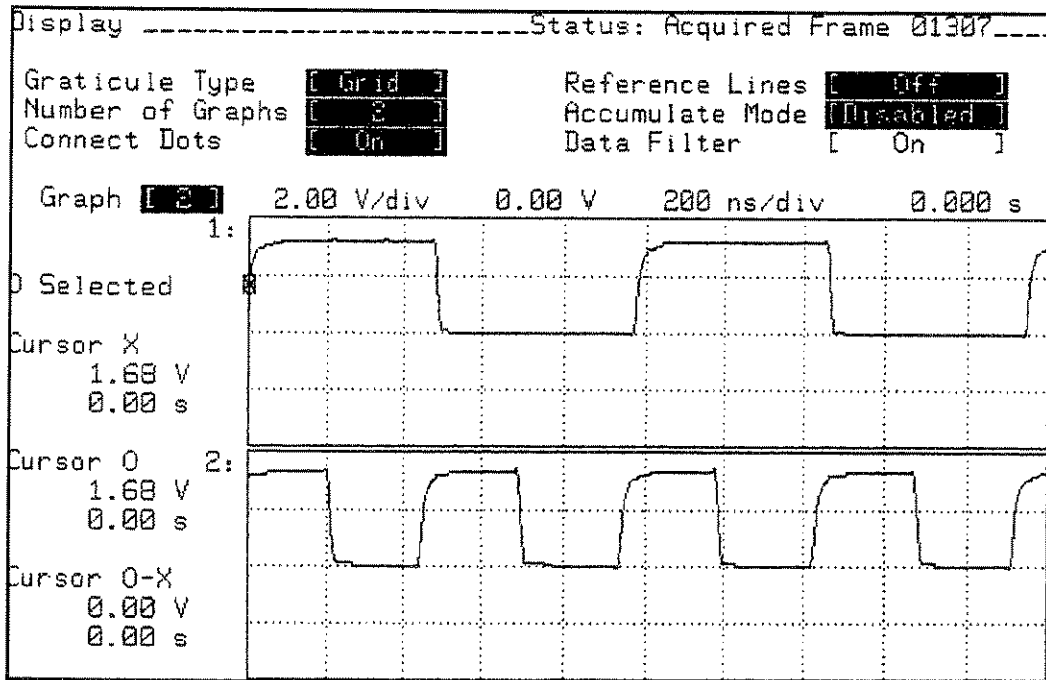

Note



The data signal INPUT 1 leading edge is triggered from the clock signal INPUT 2 positive edge.

- Change the HP 37722A CLOCK-TX to show and verify that the data signal leading edge now triggers from the displayed clock signal negative edge.

Binary Data and Clock Outputs

704 KB/s Data and Clock O/P (Opt. 003)

7. Press HP 37722A **SETTINGS** and select the following:

APPLICATION	[704kb/s]				
INTERFACE	[BINARY]	CLOCK-TX[↑], RX[↓]			
FRAME	[OFF]				
TX CLOCK SOURCE	[INTERNAL]				
PATTERN	[1010]				
ERROR ADD	[BIT] [SINGLE]				
STATUS:	0 25-1	0 15-1	0 11-1	1111	MORE

8. Set the Oscilloscope timebase Range for 5us and repeat steps 5 and 6 for 704 KB/s. Note: the period in step 6 for INPUT 2 will show 1.42us, typically.

8 Mb/s Data and Clock (Opt. 002)

9. Press HP 37722A **SETTINGS** and select 8 Mb/s BER.
10. Check that Clock and Data outputs are present for 8 Mb/s. Note the period for INPUT 2 will be 118 ns, typically.

Receiver Equalization, Additional Gain and Looped Timing

Specifications

2 Mbit/s Receiver

Rate: 2.048 Mbit/s \pm 100 ppm (G.703 specs \pm 50 ppm)

Pulse shape: Will accept any pulse shape conforming to CCITT Rec. G.703 Table 6 with between 0 and 6 dB of "root f" loss at 1.024 MHz. In addition, automatic gain control will compensate for flat loss of up to 30dB (for protected monitor points or use with a bridging probe).

Input Impedance: 120 Ω balanced or 75 Ω unbalanced (nominal) "root F" loss is a term used to describe the expected cable loss due to lengths of cable.

64 kbit/s Receiver

Codirectional Data Input

Rate: 64 kbit/s \pm 150 ppm (G.703 specs \pm 100 ppm)

Pulse shape: Will accept any pulse shape conforming to CCITT G.703, figure 5 with between 0 and 3dB of "root f" loss at 128 kHz. In addition, automatic gain control will compensate for flat loss of up to 25dB (for protected monitor points or use with a bridging probe).

Input Impedance: 120 Ω balanced (nominal).

Option 002 8 Mbit/s

Ternary Data Input

Rate: 8.448 Mbit/s \pm 100 ppm. (G.703 specs \pm 30 ppm)

Pulse shape: Will accept any pulse shape conforming to table 7/G.703 with between 0 and 6dB of "root f" loss at 4.224 MHz. In addition, automatic gain control will compensate for flat loss of up to 30dB (for protected monitor points or use with a bridging probe).

Input Impedance: 75 Ω unbalanced (nominal)

Receiver Equalization, Additional Gain and Looped Timing

Option 003 704kbit/s

Ternary Data Input

Rate: 704 kbit/s \pm 100 ppm

Pulse shape: As per 704 kBit/s Ternary Data Output with between 0 and 6dB of "root f" loss at 352 kHz. In addition, automatic gain control will compensate for flat loss of up to 30dB (for protected monitor points or use with a bridging probe).

Input Impedance: 120 Ω balanced or 75 Ω unbalanced (nominal)

Tx Clock Source: The Tx can be clocked from the Internal clock or recovered from receiver clock (loop timing)

Description

A 75mV pk-pk sinewave at half the data rate is applied to the HP 37722A receiver. This signal corresponds to a ternary all ones signal with 36 dB loss relative to the nominal signal level. To verify the HP 37722A receiver additional gain and equalization capabilities, the HP 37722A is monitored for errors with the 36 dB loss applied. With no errors displayed, the equalization and automatic gain operation is verified.

Note: For the 64 KB/s data rate a 100.8 mV pk-pk sinewave is applied to the receiver.

At all frequencies except 8.448 MB/s, the transmitter output is clocked with the clock recovered from the incoming data when loop timing is selected. Clock recovery from the incoming data, and Looped Timing are verified by monitoring the transmit frequency while varying the frequency of the receiver input signal. If the transmit frequency is locked to the receiver input frequency, clock recovery and loop timing operation is verified.

Equipment

Synthesizer	: HP 3335A
Frequency Counter	: HP 5316B Option 001
120/75 Ω Balanced to Unbalanced Converter (2 off)	: HP 15508C
75 Ω Termination	: HP 15522-80010
T Connector	

Receiver Equalization, Additional Gain and Looped Timing

Procedure

1. Recall the HP 37722A Default settings as shown on page 8-5.
2. Set the Synthesizer to generate a 1024 KHz sinewave at 75 mV pk-pk (-20.26 dBm on the HP 3335A).
3. Equipment set up:- Connect the Synthesizer 75Ω output to the HP 37722A SIGNAL IN 75Ω Unbalanced input port. Also, connect the HP 37722A SIGNAL OUT 75Ω Unbalanced port to the Frequency Counter, terminated in 75Ω (T Connector required).
4. Press HP 37722A **SETTINGS** and select the following:

APPLICATION	[2Mb/s]			
INTERFACE [TERNARY]	LINECODE [AMI]			
FRAME (G.704)	[OFF]			
TX CLOCK SOURCE	[LOOP TIMED]			
PATTERN	[1111]			
ERROR ADD [BIT] [SINGLE]				
STATUS:				
2 ¹⁵ -1	2 ¹¹ -1	1111	1010	MORE

Equalization and Automatic Gain Control - 2.048 MB/s

5. Press HP 37722A **RESULTS** and select **BASIC ERROR**.
6. Press HP 37722A **START/STOP** wait 5 seconds and verify that there are no errors displayed, and that the SIGNAL PRESENT and ALL ONES STATUS indicators are ON (HISTORY will also be ON).
7. Press HP 37722A **START/STOP** to stop the measurement.

Receiver Equalization, Additional Gain and Looped Timing

Clock Recovery and Looped Timing - 2.048 MB/s

8. Note the Frequency Counter reading (1.024 MHz - Frequency Counter triggers off +ve transitions only).
9. Increase the Synthesizer output frequency by 102 Hz (1024.102 KHz) and verify that the Frequency Counter reading increases by the same amount.
10. Set the Synthesizer output frequency to 1024 KHz and note the Frequency Counter reading.
11. Decrease the Synthesizer output frequency by 102 Hz (1023.898 KHz) and verify that the Frequency Counter decreases by the same amount.
12. Remove the cable,connected to the HP 37722A SIGNAL IN 75 Ω port and verify that the status line on the display shows LOOP TIMING CLOCK LOSS. Reconnect the cable to the HP 37722A SIGNAL IN 75 Ω port.

Equalization and Automatic Gain Control - 704 KB/s (Option 003 only)

13. Press HP 37722A **SETTINGS** and select the following:

APPLICATION	[704kb/s]				
INTERFACE	[TERNARY]	LINECODE	[AMI]		
FRAME	[OFF]				
TX CLOCK SOURCE	[LOOP TIMED]				
PATTERN	[1111]				
ERROR ADD	[BIT]	[SINGLE]			
STATUS:	2 ¹⁵ -1	2 ¹¹ -1	1111	1010	NOPE

14. Set the Synthesizer to generate a 352 KHz sinewave at 75 mV pk-pk (-20.26 dBm on the HP 3335A).
15. Press HP 37722A **RESULTS** and select **BASIC ERROR**.
16. Press HP 37722A **START/STOP** wait 5 seconds and verify that there are no errors displayed and that the SIGNAL PRESENT and ALL ONES STATUS indicators are ON (HISTORY will also be ON).
17. Press HP 37722A **START/STOP** to stop the measurement.

Receiver Equalization, Additional Gain and Looped Timing

Clock Recovery and Looped Timing - 704 KB/s (Option 003 only)

18. Note the Frequency Counter reading (352 KHz).
19. Increase the Synthesizer output frequency by 35 Hz (352.035 KHz) and verify that the Frequency Counter reading increases by the same amount.
20. Set the Synthesizer output frequency to 352 KHz and note the Frequency Counter reading.
21. Decrease the Synthesizer output frequency by 35 Hz (351.965 KHz) and verify that the Frequency Counter decreases by the same amount.

Equalization and Automatic Gain Control - 8.448 MB/s (Option 002 only)

22. Press HP 37722A **SETTINGS** and select the following:

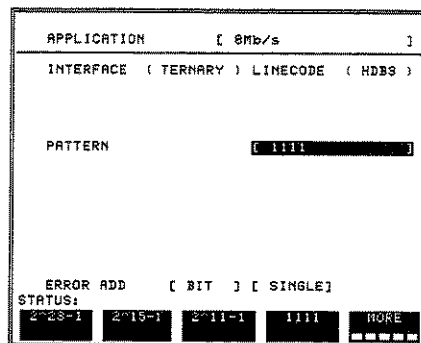

23. Set the Synthesizer to generate a 4224 KHz sinewave at 75 mV pk-pk (-20.26 dBm on the HP 3335A).
24. Press HP 37722A **RESULTS** and select **BASIC ERROR**.
25. Press HP 37722A **START/STOP** wait 5 seconds and verify that there are no errors displayed and that the SIGNAL PRESENT and ALL ONES STATUS indicators are ON (HISTORY will also be on).

Receiver Equalization, Additional Gain and Looped Timing

Equalization and Automatic Gain Control - 64 KB/s

26. Equipment set-up:- Connect the Synthesizer 75 Ω output to the HP 37722A SIGNAL IN 120 Ω input port via the Unbalanced to Balanced Converter. Also, connect the HP 37722A SIGNAL OUT 120 Ω output port to the Frequency Counter via the Balanced to Unbalanced Converter, terminated in 75 Ω (T Connector required).
27. Press HP 37722A **SETTINGS** and select the following:

APPLICATION	[64kb/s]			
INTERFACE	(CODIRECTIONAL)			
TX CLOCK SOURCE	[LOOP TIMED]			
COBIR OCTET TIMING	[OFF]			
PATTERN	[1111]			
ERROR ADD	(BIT) [SINGLE]			
STATUS:				
3 33-1	2 15-1	2 11-1	1111	NOPE

28. Set the Synthesizer to generate a 32 KHz sinewave at 100.8 mV pk-pk (-19.74 dBm on the HP 3335A).
29. Press HP 37722A **RESULTS** and select **BASIC ERROR**.
30. Press HP 37722A **START/STOP** wait 5 seconds and verify that there are no errors displayed and that the SIGNAL PRESENT and ALL ONES STATUS indicators are ON (OCTET LOSS and HISTORY will also be ON).

Clock Recovery and Looped Timing - 64 KB/s

31. Note the Frequency Counter reading.
32. Increase the Synthesizer output frequency by 4.8 Hz (32004.8 Hz) and verify that the Frequency Counter reading increases by the same amount.
33. Set the Synthesizer output frequency to 32 KHz and note the Frequency Counter reading.
34. Decrease the Synthesizer output frequency by 4.8 Hz (31995.2 Hz) and verify that the Frequency Counter decreases by the same amount.

Receiver Equalization, Additional Gain and Looped Timing

Receiver Frequency Measurement

Specifications

Frequency Offset

Display Format: \pm XXX ppm

Range: -199 ppm to +199 ppm

Resolution: 1 ppm

Accuracy: \pm 10 ppm

Ageing: \pm 2 ppm per year (typical)

Description

This test verifies that the recovered clock frequency measurement capability is within 12 PPM \pm 1count with the provision that the instrument has been through its yearly calibration cycle.

Note



A Synthesizer is used to generate a signal at half the data rate which corresponds to an all ones ternary signal at the receiver input.

Frequency Offset is also verified during this test.

Equipment

Synthesizer : HP 3335A

Procedure

1. Recall the HP 37722A Default settings as shown on page 8-5.
2. Set the Synthesizer to generate a 1024 KHz sinewave at 0dBm amplitude.

Frequency Measurement

3. Connect the Synthesizer 75 Ω output to the HP 37722A SIGNAL IN75 Ω Unbalanced port.

Receiver Frequency Measurement

4. Press HP 37722A **SETTINGS** and select the following:

APPLICATION	[2Mb/s]		
INTERFACE	[TERNARY]	LINECODE	[AMI]
FRAME (G.704)	[OFF]		
TX CLOCK SOURCE	[INTERNAL]		
PATTERN	[1111]		
ERROR ADD	[BIT]	[SINGLE]	
STATUS:	2 15-1	2 11-1	1111 1010
			HOPE

5. Press HP 37722A **RESULTS** and select **SIGNAL**.
6. Verify that the HP 37722A **FREQUENCY** displayed is between 2048025 Hz and 2047975 Hz.
Frequency Offset
7. Increment the Synthesizer frequency until the HP 37722A display shows **RX FREQUENCY OFFSET +199ppm** (approx 1024204 Hz). Note: +199ppm is the upper range limit, beyond this point the display shows O/R.
8. Verify that the Synthesizer frequency is set for between 1024207 Hz and 1024201 Hz.
9. Decrement the Synthesizer frequency until the HP 37722A display shows **RX FREQUENCY OFFSET -199ppm** (approx 1023796 Hz). Note: -199ppm is the lower range limit, beyond this point the display shows U/R.
10. Verify that the Synthesizer frequency is set for between 1023799 Hz and 1023793 Hz.

Alarms Tests

Description

The transmitters ability to generate alarms and error sequences for checking alarm thresholds, and to test the receivers ability to detect these alarms is verified during Self Test. This is a functional test of the alarm conditions not covered in self test.

Equipment

None

Procedure

1. Recall the HP 37722A Default settings as shown on page 8-5.
2. If the HISTORY led in the STATUS area of the front panel is on, press **RESET HISTORY**.
3. Connect the HP 37722A SIGNAL OUT 75Ω Unbalanced port to the SIGNAL IN 75Ω Unbalanced port. The SIGNAL PRESENT led should be on.
4. Press HP 37722A **START/STOP** to start a measurement.
5. Press HP 37722A **SINGLE ERROR ADD** several times - the ERRORS led should come on when the key is pressed. Ensure that the HISTORY led is on.
6. Press **SHOW HISTORY** to view the results of the receiver seeing errors - ERRORS led should come on (the HISTORY led goes off while the key is pressed).
7. Press HP 37722A **RESET HISTORY**. Ensure that the HISTORY led goes off and that when **SHOW HISTORY** is pressed, no red leds come on.
8. Press HP 37722A **START/STOP** to stop the measurement.

Mux & Demux Tests

Specifications

V.24 Data Access

Rate: 64 kbit/s

Mode: DCE

Connector: 25-pin D-type side panel

Demux: A single timeslot (at 64kbit/s) can be extracted from the received 2Mbit/s data and retransmitted on a V.24 interface.

Mux: A 64kbit/s data stream can be received at the V.24 interface and retransmitted in one timeslot of the transmitted 2 Mbit/s data.

Mux and demux can operate simultaneously.

Description

These tests verify -

a) the HP 37722A's ability to take a 64 Kb/s signal applied to the Datacom (V.24) interface, via a loopback connection, and multiplex it up into a timeslot within the 2.048 Mb/s transmitted stream.

b) the HP 37722A's ability to receive a 2.048 Mb/s stream and demultiplex a timeslot at 64 Kb/s down to the Datacom interface.

Equipment

Oscilloscope : HP 54201A/D
10:1 Divider Probe : HP 10435A
Loopback Connector : HP 5060-4462
75 Ω Termination : HP 15522-80010
T Connector :

Mux & Demux Tests

Procedure

1. Ensure that there are no connections made to the front panel ports.
2. Recall the HP 37722A Default settings as shown on page 8-5.

Multiplexing

3. Connect the loopback connector to the DATACOM port - left side panel with instrument front panel facing you. Also, Connect the SIGNAL OUT port to the Oscilloscope INPUT 1, terminated in 75Ω (T Connector required).
4. Press HP 37722A **OTHER**, select **MISCELLANEOUS** (use **MORE** to bring up the MISCELLANEOUS field) and set the DESELECTED TIMESLOTS for ALL ONES.
5. Press HP 37722A **SETTINGS** and select the following:

Note: The APPLICATION is set for 2Mb/s EXTERNAL D & I.

APPLICATION	[2Mb/s EXTERNAL D&I]
INTERFACE [BINARY]	CLOCK-TX[↑], RX[↓]
FRAME (6.704)	[NO NFM]
THROUGH MODE	[OFF]
TX CLOCK SOURCE	[INTERNAL]
EXTERNAL DROP & INSERT	[DATACOM]
INSERT TO TIMESLOT	[1] [OFF]
DROP FROM TIMESLOT	[1]
SPEAKER / MICROPHONE	[OFF]
STATUS:	
CAS NFM	NO NFM
CAS, CRC4	CRC4 NFM

6. Configure the Oscilloscope as follows, then display Channel 1.

Mux & Demux Tests

Status	[Configuration]	-----	Status: Waiting for Trigger	-----
			REM MTA	
			Setup Label	██████████
Channel	[Dual]		Timebase	
	Input 1	Input 2	Sampling @	5.00 MHz
Range	8.0 V	40 mV	Mode	[Single]
Offset	1.247 V	0.000 V	Range	200 μs
Probe	[1:1]	[1:1]	Acquire	[Real Time]
Coupling	[dc] [1 MΩ]	[dc] [1 MΩ]	Delay	-20.0000 μs
Store Mode	[Envelope]	[Envelope]	Reference	[Left]
Auto Scale	[Disabled]	[Disabled]	Auto Scale	[Disabled]
Label	██████████	██████████		
Trigger				
				* Refer to State Trigger Menus for Assignment and Sequence
Mode	[Analog Only]			
Analog Source	[Chan 1]	[+ Slope]	Auto Scale	[Disabled]
Level	[Adjust]	1.500 V	On Event	00001
Probe	[1:1]		Coupling	[dc] [1 MΩ]

7. Press the Oscilloscope RUN/STOP key to obtain waveform shown below:

Mux & Demux Tests

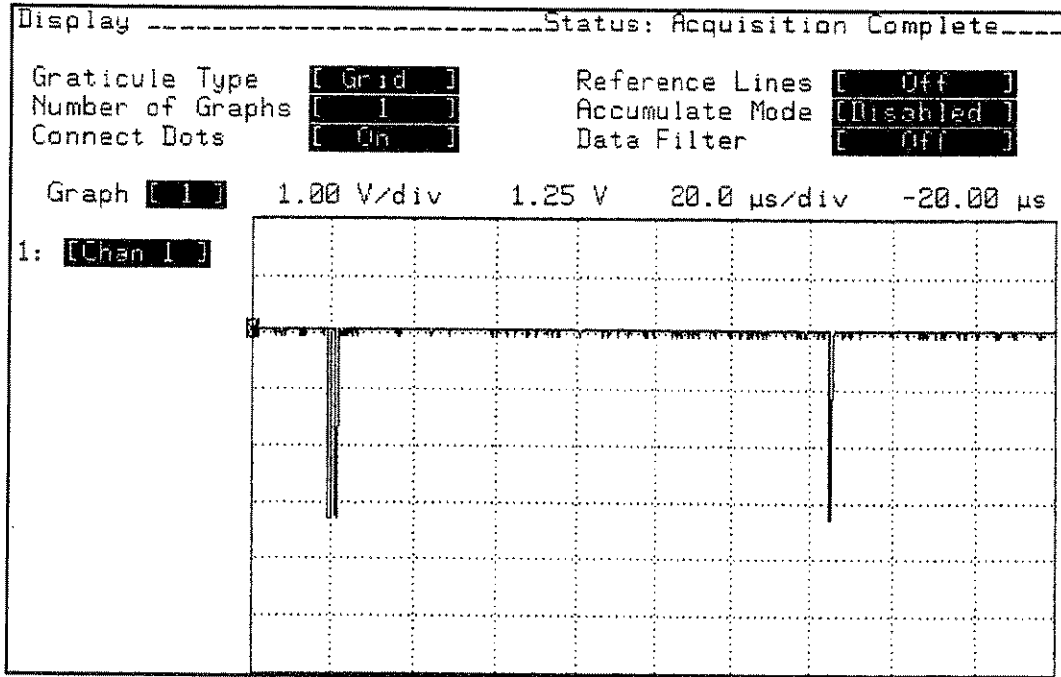

8. Set the displayed INSERT TO TIMESLOT fields for [01] [ON].

Mux & Demux Tests

9. Press the Oscilloscope RUN/STOP key and verify that the waveform shown below can be obtained:

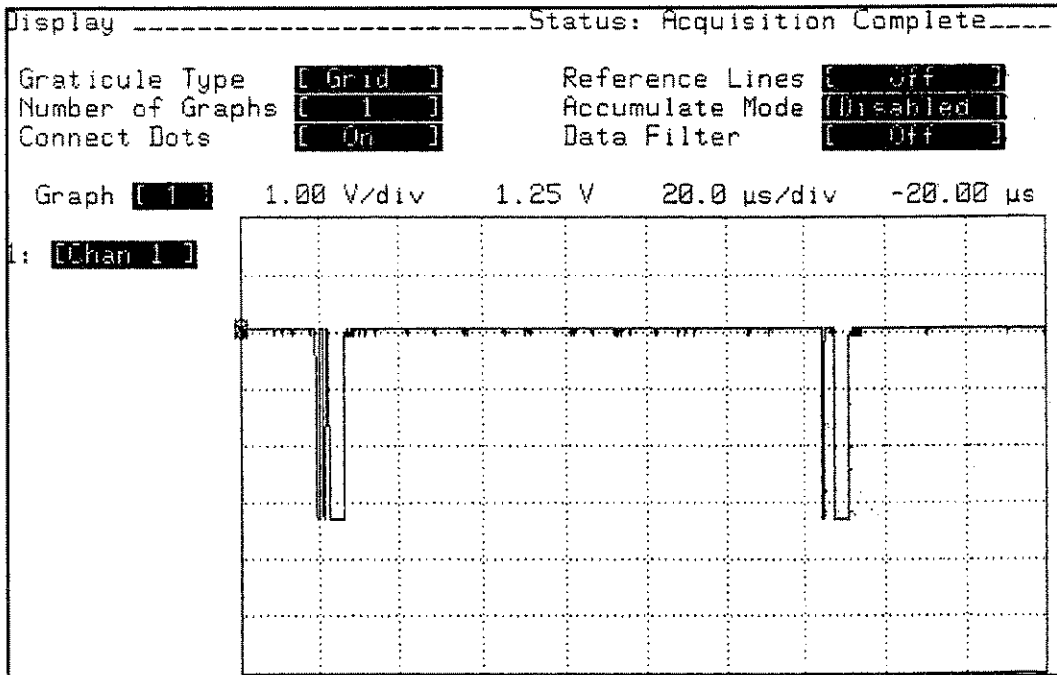

Mux & Demux Tests

Demultiplexing

10. Set the displayed INSERT TO TIMESLOT fields for [01] [OFF] and the DROP FROM TIMESLOT field for [11].
11. Connect the SIGNAL OUT 75Ω Unbalanced port to the SIGNAL IN 75Ω Unbalanced port and the CLOCK OUT port to the CLOCK IN port.
12. Press HP 37722A **OTHER** and set the DESELECTED TIMESLOTS field for 2^6-1 .
13. Configure the Oscilloscope as shown below, then display Channel 1.

Status [Configuration]		Status: No Trigger Found	
		REM MTA	
Setup Label [REDACTED]			
Channel [Dual]	Input 1	Input 2	Timebase
Range [40 V]	[40 mV]		Sampling @ [200 kHz]
Offset [0.000 V]	[0.000 V]		Mode [Auto]
Probe [10:1]	[1:1]		Range [5.00 ms]
Coupling [dc] [1 MΩ]	[dc] [1 MΩ]		Acquire [Real Time]
Store Mode [Normal]	[Envelope]		Delay [-20.0000 μs]
Auto Scale [Disabled]	[Disabled]		Reference [Left]
Label			Auto Scale [Disabled]
Trigger			
Mode [Analog Only]		* Refer to State Trigger Menus for Assignment and Sequence	
Analog Source [Chan 1]	[+ Slope]	Auto Scale [Disabled]	
Level [Adjust]	[500.0 mV]	On Event [00001]	
Probe [10:1]		Coupling [dc] [1 MΩ]	

14. Remove the loopback connector and probe the Datacom port connector pin 3 with the Oscilloscope probe and verify that the following PRBS waveform can be obtained:

8-70 Performance Tests

Mux & Demux Tests

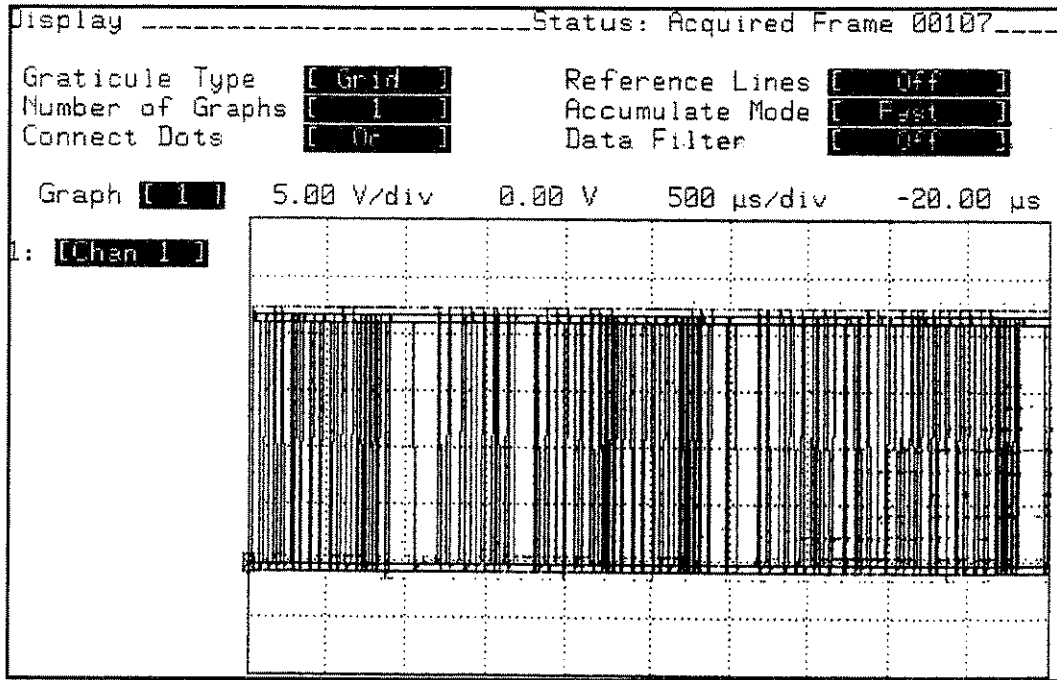

15. Set the displayed DESELECTED TIMESLOTS field for ALL ONES and verify that the following Oscilloscope waveform can be obtained. Note: an ALL ONES signal over the V.24 port is displayed as a negative 10 volt level:

Mux & Demux Tests

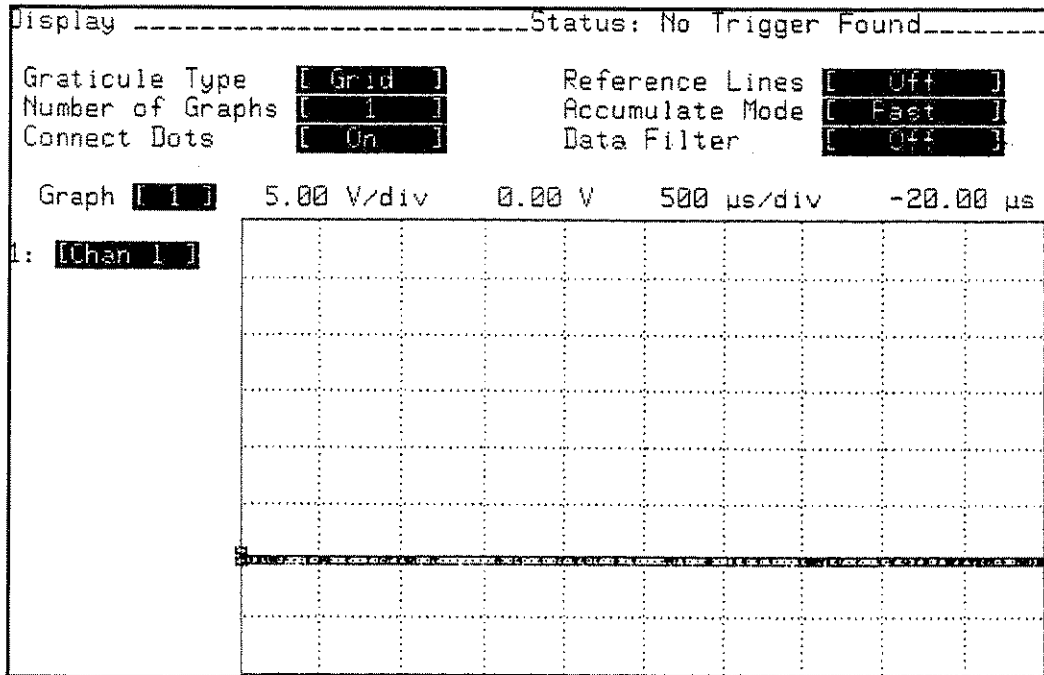

Mux & Demux Tests (Options 005/006 only)

Specifications

External X.21 data access to n unstructured 64 kbit/s timeslots within a 2 Mbit/s signal (n = 1 to 6)

Description

These tests verify:

- a) the HP 37722A's ability to take a 64 Kb/s signal applied to the Datacom (X.21) interface, via a loopback connection, and multiplex it up into a timeslot within the 2.048 Mb/s transmitted stream.
- b) the HP 37722A's ability to receive a 2.048 Mb/s stream and demultiplex a timeslot at 64 Kb/s down to the Datacom interface.

Equipment

Oscilloscope	: HP 54201A/D
10:1 Divider Probe	: HP 10435A
15 way X.21 Mating Connector	: HP 1251-5503
75 Ω Termination	: HP 15522-80010
T Connector	

Procedure

1. Ensure that there are no connections made to the front panel ports.
2. Recall the HP 37722A Default settings as shown on page 8-5.

Multiplexing

3. Take the 15 way connector (1251-5503) and use wire links to connect pins 2 to 4 and 9 to 11 (see following figure). Connect the modified 15 way connector to the DATACOM port - left side panel with instrument front panel facing you. Also, Connect the SIGNAL OUT port to the Oscilloscope INPUT 1, terminated in 75 Ω (T Connector required).

Mux & Demux Tests (Options 005/006 only)

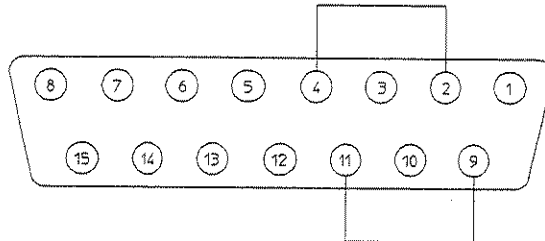

15 way connections on the pin side of HP 1251-5503

4. Press HP 37722A **OTHER**, select **MISCELLANEOUS** (use **MORE** to bring up the MISCELLANEOUS field) and set the DESELECTED TIMESLOTS for ALL ONES.
5. Press HP 37722A **SETTINGS** and select the following:

Note: The APPLICATION is set for 2Mb/s EXTERNAL D & I.

```
APPLICATION      [ 2Mb/s EXTERNAL D&I ]
-----
INTERFACE [ BINARY ] CLOCK-TX[↑], RX[↓]
FRAME (G.704)      [ NO MFM ]
THROUGH MODE      [ OFF ]
TX CLOCK SOURCE   [ INTERNAL ]
-----
EXTERNAL DROP & INSERT [ DATACOM ]
INSERT CONTROL    [ OFF ]
DROP TIMESLOTS   [ 8S PER INSERT ]
I- [ Fw..... ]
   0-----91
                        Bandwidth 64kb/s
-----
STATUS:
 8S PER INSERT  SELECT
```

6. Configure the Oscilloscope as follows, then display Channel 1.

Mux & Demux Tests (Options 005/006 only)

Status	[Configuration]		Status: Waiting for Trigger
			REM MTA
	Setup Label		
Channel	[Dual]		Timebase
	Input 1	Input 2	Sampling @ 5.00 MHz
Range	8.0 V	40 mV	Mode [Single]
Offset	1.247 V	0.000 V	Range [200 μ s]
Probe	[1:1]	[1:1]	Acquire [Real Time]
Coupling	[dc] [1 Mn]	[dc] [1 Mn]	Delay [-20.0000 μ s]
Store Mode	[Envelope]	[Envelope]	Reference [Left]
Auto Scale	[Disabled]	[Disabled]	Auto Scale [Disabled]
Label			
Trigger	* Refer to State Trigger Menus for Assignment and Sequence		
Mode	[Analog Only]		
Analog Source	[Chan 1]	[+ Slope]	Auto Scale [Disabled]
Level	[Adjust]	1.500 V	On Event [0000]
Probe	[1:1]		Coupling [dc] [1 Mn]

7. Press the Oscilloscope RUN/STOP key to obtain waveform shown below. You may need to press RUN/STOP several times to display the pulses in the order shown in the following figure.

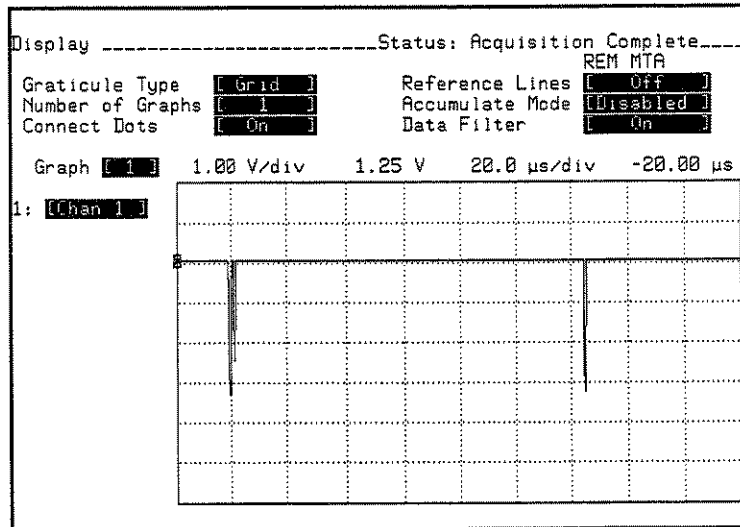

8. Set the displayed INSERT CONTROL field from [OFF] to [ON].

Mux & Demux Tests (Options 005/006 only)

9. Press the Oscilloscope RUN/STOP key and verify that the waveform shown below can be obtained:

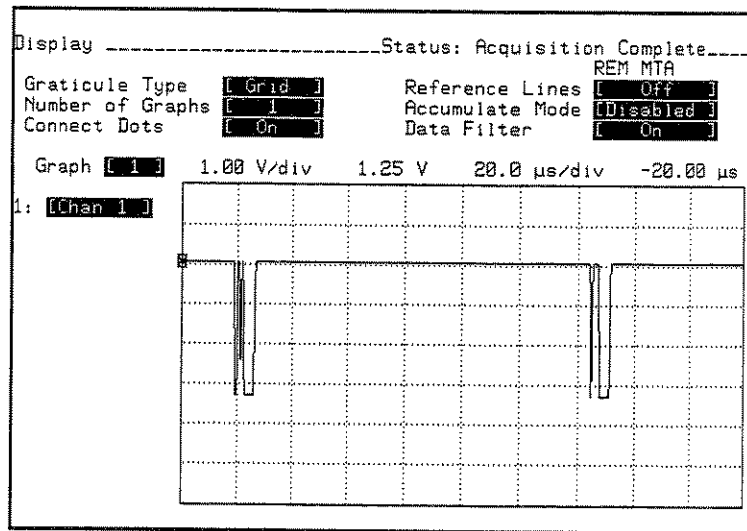

Demultiplexing

10. Press HP 37722A **SETTINGS** and select the following:

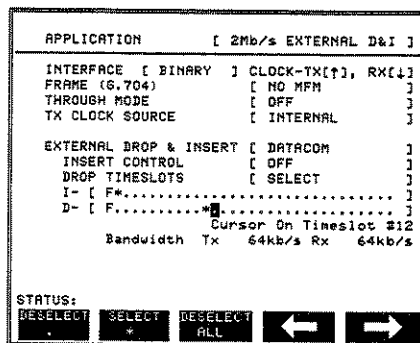

Mux & Demux Tests (Options 005/006 only)

11. Connect the SIGNAL OUT 75Ω Unbalanced port to the SIGNAL IN 75Ω Unbalanced port and the CLOCK OUT port to the CLOCK IN port.
12. Press HP 37722A **OTHER** and set the DESELECTED TIMESLOTS field for 2⁶-1.
13. Configure the Oscilloscope as shown below, then display Channel 1.

Status [Configuration]		Status: Acquisition Complete	
		REM MTA	
Setup Label [REDACTED]			
Channel [Dual]		Timebase	
	Input 1	Input 2	Sampling @ 200 kHz
Range	10 V	40 mV	Mode [Auto]
Offset	0.000 V	0.000 V	Range [5.00 ms]
Probe	[10:1]	[1:1]	Acquire [Real Time]
Coupling	[dc] [1 MΩ]	[dc] [1 MΩ]	Delay [20.0000 μs]
Store Mode	[Normal]	[Envelope]	Reference [Left]
Auto Scale	[Disabled]	[Disabled]	Auto Scale [Disabled]
Label			
Trigger			
Mode [Analog Only]		* Refer to State Trigger Menus for Assignment and Sequence	
Analog Source	[Chen 1] [+ Slope]	Auto Scale	[Enabled]
Level	[Adjust] [500.0 mV]	On Event	[00001]
Probe	[10:1]	Coupling	[dc] [1 MΩ]

14. Remove the loopback connector from the DATACOM port and probe the Datacom port connector pin 4 with the Oscilloscope probe and verify that a PRBS waveform can be obtained. The following figure shows a typical waveform.

Mux & Demux Tests (Options 005/006 only)

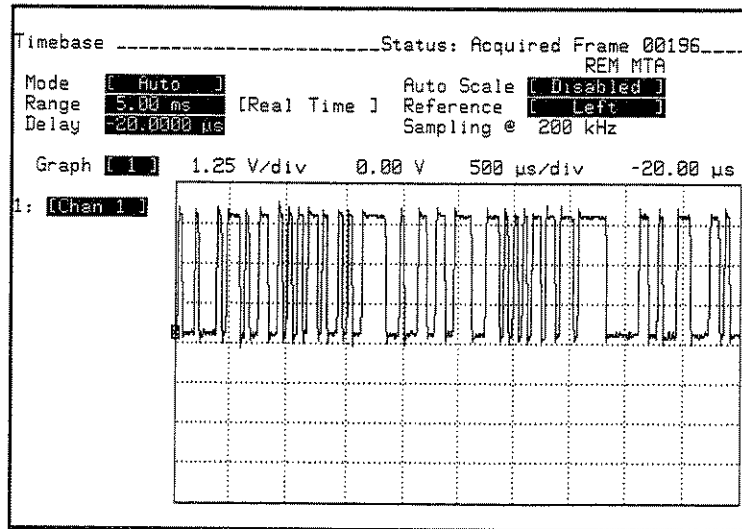

15. Set the displayed DESELECTED TIMESLOTS field for ALL ONES and verify that the Oscilloscope shows a 0V DC level. - note: an ALL ONES signal over the X.21 port is displayed as a 0 volt level:

External Drop and Insert (Options 005/006 only)

Specifications

Input

Connector: 3-pin Siemens on side panel

Impedance: 600 Ω balanced (nominal)

TLP: 0.0dB (nominal)

Output

Connector: 3-pin Siemens on side panel

Impedance: 600 Ω balanced (nominal)

TLP: 0.0dB (nominal)

Description

This test verifies that an externally applied analog signal can be coded, inserted into a framed structure timeslot, transmitted digitally from Tx to Rx then decoded back to an analog signal.

Equipment

Synthesizer : HP 3336A
Oscilloscope : HP 54201A/D
10 : 1 Divider Probe : HP 10435A

Procedure

1. Recall the HP 37722A Default settings as shown on page 8-5.
2. Set the Synthesizer to generate a 1000 Hz sinewave at 0 dBm Amplitude.
3. Equipment set up: Connect the Synthesizer 600 Ω output to the HP 37722A 600 Ω AUDIO I/P (side panel). Also, connect the SIGNAL OUT 75 Ω Unbalanced port to the SIGNAL IN 75 Ω Unbalanced port.
4. Press HP 37722A Settings and select the following:

External Drop and Insert (Options 005/006 only)

APPLICATION	[2Mb/s EXTERNAL D&I]
INTERFACE [TERNARY]	LINECODE [HDB3]
FRAME (8,704)	[CAS MFM]
THROUGH MODE	[OFF]
TX CLOCK SOURCE	[INTERNAL]
EXTERNAL DROP & INSERT	[6000 AUDIO]
INSERT TO TIMESLOT [1]	[ON]
DROP FROM TIMESLOT [1]	[]
SPEAKER / MICROPHONE	[OFF]
STATUS:	
OFF	ON

5. Connect the Oscilloscope 10:1 probe to the 600Ω AUDIO O/P centre pin and verify that a 2.2V pk-pk (typically) sinewave with a period of 1.0ms is displayed.
6. Use the HP 37722A cursor keys to highlight the displayed SPEAKER/MICROPHONE field and select **ON**.
7. Press HP 37722A **VOL** to verify that the 1 KHz tone is audible from the loudspeaker. Vary the volume level using the **VOL** control keys to ensure that the tone can be increased and reduced to a point where no tone is audible from the loudspeaker.

Auto Configure

Specifications

Auto setup: Bit rate, line code, framing and pattern are automatically determined when the Auto Setup button is pressed.

Description

The HP 37722A's ability to auto configure onto incoming data is verified using a Synthesizer set for half the data rate which corresponds to a ternary all ones signal at the HP 37722A receiver.

Equipment

Synthesizer HP 3335A

Procedure

1. Recall the HP 37722A Default settings as shown on page 8-5.
2. Set the Synthesizer to generate a 1024 KHz sinewave at 0 dBm Amplitude.
3. Connect the Synthesizer 75 Ω output to the HP 37722A SIGNAL IN 75 Ω Unbalanced port.
4. Place the cursor on the displayed PATTERN field and note that the display shows the following:

Auto Configure

APPLICATION	[2Mb/s]			
INTERFACE [TERNARY]	LINECODE [HDDB]			
FRAME (G.704)	[CAS MFM]			
THROUGH MODE	[OFF]			
TX CLOCK SOURCE	[INTERNAL]			
PATTERN	[2-15-1]			
RECEIVE TIMESLOT	[AS PER TX]			
Tx [F*.....S.....]				
	Bandwidth 64kb/s			
ALARM GENERATION	[OFF]			
ERROR ADD [BIT]	[SINGLE]			
STATUS:				
2-23-1	2-15-1	2-11-1	1111	NONE

5. Press HP 37722A **AUTO SETUP** and verify that the display configures as shown below (the **SIGNAL PRESENT** and **AIS** leds should be on):

APPLICATION	[2Mb/s]			
INTERFACE [TERNARY]	LINECODE [HDDB]			
FRAME (G.704)	[OFF]			
TX CLOCK SOURCE	[INTERNAL]			
PATTERN	[1111]			
ERROR ADD [BIT]	[SINGLE]			
STATUS:				
2-23-1	2-15-1	2-11-1	1111	NONE

Wander and Bit Slips (Option 010 instruments only)

Specifications

Rate: 2.048 Mbit/s \pm ppm (G.703 specs \pm 50 ppm)

Pulse Shape: Will accept any pulse shape conforming to CCITT Rec. G.703 Table 6 with between 0 and 6 dB of "root f" loss at 1.024 MHz.

Input Impedance: 75 Ω unbalanced.

Description

A 2 Mb/s signal is input at the 75 Ω SIGNAL IN port and the clock is recovered from the incoming signal. This recovered clock is compared to a reference clock which is recovered from an external reference signal input at the rear panel REF IN port. Any difference in relative frequency between the incoming signal and the reference signal is measured as Wander and Bit Slips.

Note: The maximum number of consecutive zeros allowed in the incoming signal is 10.

Equipment

T-Connector

Procedure

1. Recall the HP 37722A DEFAULT SETTINGS as shown on Page 8-5.
2. Connect a T-connector to the HP 37722A 75 Ω unbalanced SIGNAL OUT port.
3. Connect one port of the T-connector on the 75 Ω unbalanced SIGNAL IN port.
4. Select the following parameters:

LINECODE	:	AMI	
FRAME (G.704)	:	OFF	
PATTERN	:	[2 ¹ -1]
PRBS POLARITY	:	[NORM]	CCITT

5. Press RESULTS key and select DISPLAY : [SIGNAL] on the RESULTS page.
6. Check that the RX FREQUENCY is between 2048025 Hz and 2047975 Hz and that the OFFSET REF. INTERNAL is $+0 \text{ ppm} \pm 12 \text{ ppm}$.
7. Check that the REF. EXTERNAL indicates NO REF ppm.
8. Connect the other port of the T-connector on the 75Ω unbalanced SIGNAL OUT port to the REF IN port on the rear panel.
9. Check that the REF. EXTERNAL is now the same as the OFFSET REF. INTERNAL.
10. Select MEASUREMENTS : [GATED] and press the START/STOP key.
11. Check that the PATTERN SLIPS, WANDER PEAK and BIT SLIPS results are zero.

Performance Test Record

Page No.	Test Description	Result		
		Min	Actual	Max
	<i>Telecom Analyzer Self Test</i>			
8-32	Step 6: "TEST STATUS PASSED" displayed.			
	Step 9: "SIGNAL PRESENT" LED on.			
	<i>Internal Transmitter Clocks</i>			
8-35	Step 4: Frequency Counter reading.	1023987.7Hz		1024012.3Hz
	Step 6: Frequency Counter reading.	31999.6161Hz		32000.384Hz
8-36	Step 8: Frequency Counter reading.	4223949.3Hz		4224050.7Hz
	Step 10: Frequency Counter reading.	351995.77Hz		352004.22Hz
	<i>External Transmitter Clocks</i>			
8-38	Step 6: LED indications correct.			
	Step 7: LED indications correct.			
	Step 8: LED indications correct.			
	<i>64 kHz</i>			
8-39	Step 14: LED indications correct.			
	Step 15: LED indications correct.			
	Step 16: LED indications correct.			

Performance Test Record (continued)

Page No.	Test Description	Result		
		<i>Min</i>	<i>Actual</i>	<i>Max</i>
	<i>Transmitter Output</i>			
8-42	Step 7: peak pulse amplitude.	2.133V		2.607V
8-43	Step 8: pulse width at half pulse amplitude.	219ns		269ns
	Step 11: pulse falls within the mask.			
	Step 13: Repeat of Steps (7) to (11).			
	(7) peak pulse amplitude	2.133V		2.607V
	(8) pulse width at half pulse amplitude.	219ns		269ns
	(11) pulse falls within the mask.			
8-44	Step 15: Repeat of Steps (6) to (13).			
	(7) peak pulse amplitude	2.133V		2.607V
	(8) pulse width at half pulse amplitude.	219ns		269ns
	(11) pulse falls within the mask.			
	Step 15: Repeat of Step (13), Repeat of Steps (7) to (11).			
	(7) peak pulse amplitude	2.133V		2.607V
	(8) pulse width at half pulse amplitude.	219ns		269ns
	(11) pulse falls within the mask.			

Performance Test Record (continued)

Page No.	Test Description	Result		
		<i>Min</i>	<i>Actual</i>	<i>Max</i>
8-45	Step 20: peak pulse amplitude.	0.9V		1.1V
	Step 21: pulse width at half pulse amplitude.	3.51us		4.29us
	Step 23: pulse falls within the mask.			
8-46	Step 25: Repeat of Steps (20) to (23).			
	(20) peak pulse amplitude	0.9V		1.1V
	(21) pulse width at half pulse amplitude.	3.51us		4.29us
8-47	Step 30: peak pulse amplitude.	2.133V		2.607V
	Step 31: pulse width at half pulse amplitude.	49ns		69ns
	Step 33: pulse falls within the mask.			
8-48	Step 35: Repeat of Steps (30) to (33).			
	(30) peak pulse amplitude	2.133V		2.607V
	(31) pulse width at half pulse amplitude.	49ns		69ns
8-49	Step 40: pulse characteristics.			

Performance Test Record (continued)

Page No.	Test Description	Result		
		<i>Min</i>	<i>Actual</i>	<i>Max</i>
8-50	Step 41: pulse characteristics are correct. Step 43: Repeat of Steps (39) to (41). (40) pulse characteristics are correct. (41) pulse characteristics are correct.			
	<i>Binary Data and Clock Outputs</i>			
8-53	Step 5: Waveform obtained. INPUT 1 Mark INPUT 1 Space INPUT 2 Mark INPUT 2 Space INPUT 2 Duty INPUT 2 Period 488ns (typically)	3V 3V 44%		0.5V 0.5V 56%
	Step 6: Data leading edge triggered from clock negative edge			
8-55	Step 8: Repeat of Steps (5) and (6). (5) Waveform obtained. INPUT 1 Mark INPUT 1 Space INPUT 2 Mark INPUT 2 Space INPUT 2 Duty INPUT 2 Period 1.43us (typically) (6): Data leading edge triggered from clock negative edge	3V 3V 44:56 %		0.5V 0.5V 56:44 %
	Step 10: Repeat of Steps (6) and (7).			

8-88 Performance Tests

Performance Test Record (continued)

Page No.	Test Description	Result		
		<i>Min</i>	<i>Actual</i>	<i>Max</i>
	<i>Receiver Equalization, Gain and Looped Timing</i>			
8-58	Step 6: no errors displayed, SIGNAL PRESENT & ALL ONES leds ON.			
8-59	Step 9: Frequency Counter reading 1024.102KHz.			
	Step 11: Frequency Counter reading 1023.898KHz.			
	Step 12: Status LOOP TIMING LOSS.			
	Step 16: no errors displayed, SIGNAL PRESENT & ALL ONES leds ON.			
8-60	Step 19: Frequency Counter reading 352.035KHz.			
	Step 21: Frequency Counter reading 351.965KHz.			
	Step 25: no errors displayed, SIGNAL PRESENT & ALL ONES leds ON.			

Performance Test Record (continued)

Page No.	Test Description	Result		
		<i>Min</i>	<i>Actual</i>	<i>Max</i>
8-61	Step 30: no errors displayed, SIGNAL PRESENT & ALL ONES leds ON. Step 32: Frequency Counter reading 32004.8Hz. Step 34: Frequency Counter reading 31995.2Hz.			
	<i>Receiver Frequency Measurement</i>			
8-63	Step 6: Frequency displayed.	2047975Hz		2048025Hz
	Step 8: Frequency Synthesizer setting	1024201Hz		1024207Hz
	Step 10: Frequency Synthesizer setting	1023793Hz		1023799Hz
	<i>Alarms Test</i>			
8-64	Alarm indications correct.			
	<i>Mux & Demux</i>			
8-69	Step 9: Waveform correct.			
8-70	Step 14: PRBS waveform correct.			
8-71	Step 15: ALL ONES waveform correct.			

8-90 Performance Tests

Performance Test Record (continued)

Page No.	Test Description	Result		
		<i>Min</i>	<i>Actual</i>	<i>Max</i>
	<i>Mux & Demux (Options 005/006)</i>			
8-75	Step 7: Waveform correct.			
8-76	Step 9: Waveform correct.			
8-77	Step 14: Waveform correct.			
8-78	Step 15: 0 V displayed.			
	<i>External Drop and Insert (Options 005/006 only)</i>			
8-80	Step 5: Waveform correct.			
	Step 7: Volume varies			
	<i>Auto Configure</i>			
8-82	Step 5: Display correct.			
	<i>Wander and Bit Slips (Option 010)</i>			
8-84	Step 9: REF. EXTERNAL same as OFFSET REF. EXTERNAL			
	Step 11: PATTERN SLIPS, WANDER PEAK and BIT SLIPS all zero.			

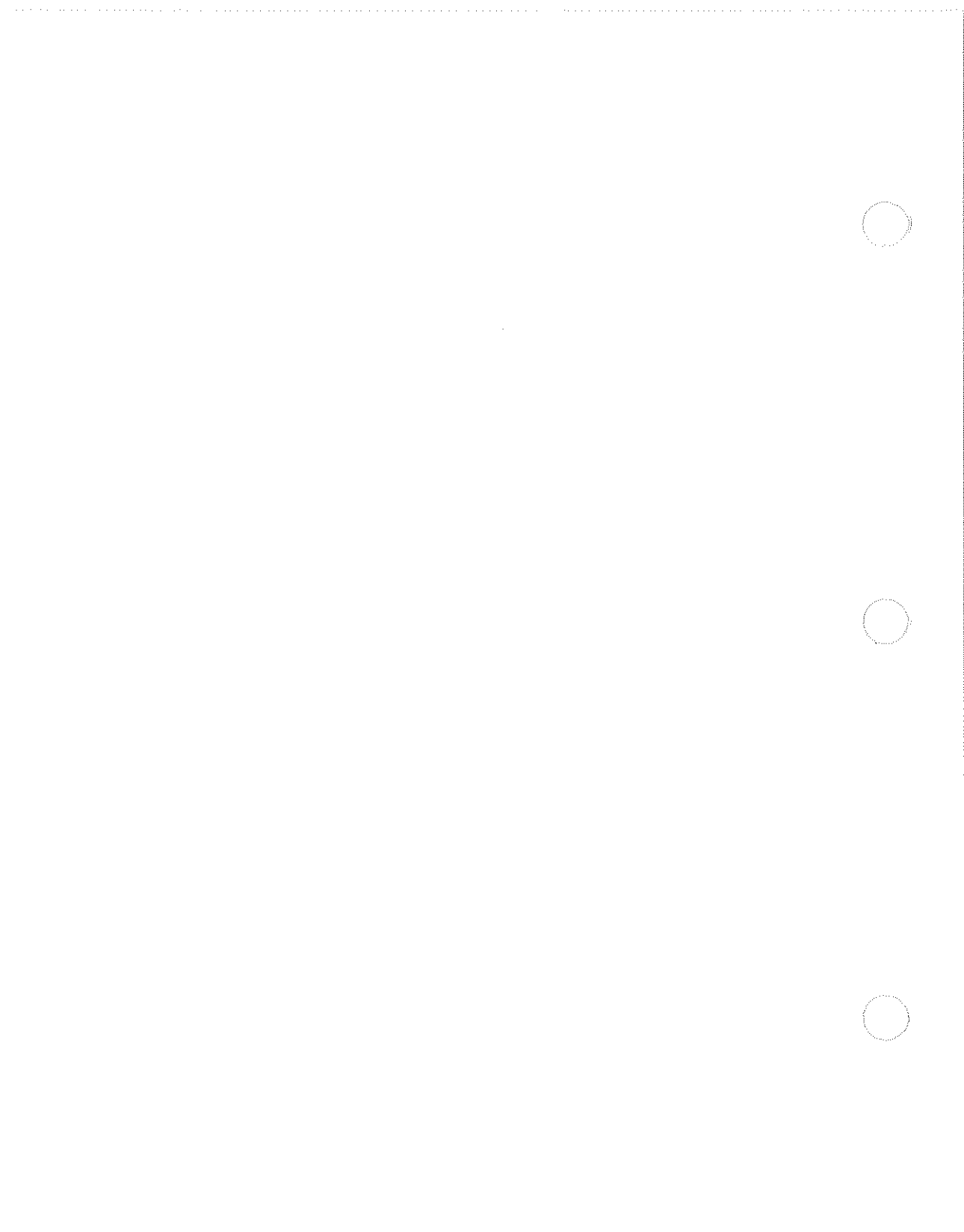

Remote Control

There are three forms of remote control available:

- Virtual remote, (option V01) using software HP 15800A. This provides operation via a front panel displayed on a workstation, the keys being operated with a mouse. Separate documentation is supplied for this type of remote operation.
- RS-232 commands from a terminal or computer.
- HP-IB commands from a computer (option H01)

Tests may be set up and run, results may be stored and retrieved, using the remote control facility. The operation of the Analyzer is the same as in manual operation from the front panel.

Additional facilities are available when using remote control:

Complete test configurations may be down loaded to the Analyzer either for immediate use or to be stored in the analyzer memory for future use.

Results may be returned to the controller for display, printing or further analysis.

Preparation for Remote Control

The Analyzer may be controlled directly from a controller at the same location as the Analyzer, or over a telephone link via modems.

Where control is over a telephone link, the link may be a leased line or a dial-up line.

The controller may be a “dumb” terminal or a computer.

The Analyzer must be correctly connected and correctly set up for successful remote control.

The RS-232 port may be configured for either printer or remote control operation. When printer operation is selected, 8 bit data is transmitted and Xon/Xoff selection may be "ON" or "OFF" only. When remote control operation is selected, 7 bit data is assumed and Xon/Xoff selections are :

OFF, Rx ONLY, Tx ONLY or Rx AND Tx.

The analyzer receive buffer has a capacity of 128 bytes.

Remote Control / Printer Pin Assignments

Pin	Mnemonic	Description
1	PGND	Connected to chassis ground
2	TXD	37722A data input
3	RXD	37722A data output
4	RTS	Looped to pin 5
5	CTS	Looped to pin 4
7	SGND	Signal ground
20	DTR	Inhibits data output from the 37722A when held "OFF" by the receiving device.

To Connect to Telephone Lines via Modems

The connections of a cable suitable for Analyzer / modem connection are shown in the following figure.

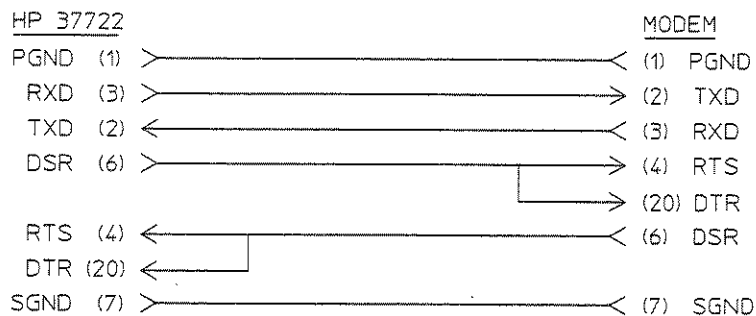

9-2 Remote Control

To Connect for Direct Operation

The connections of a cable suitable for direct connection to a controller are shown in the following figure.

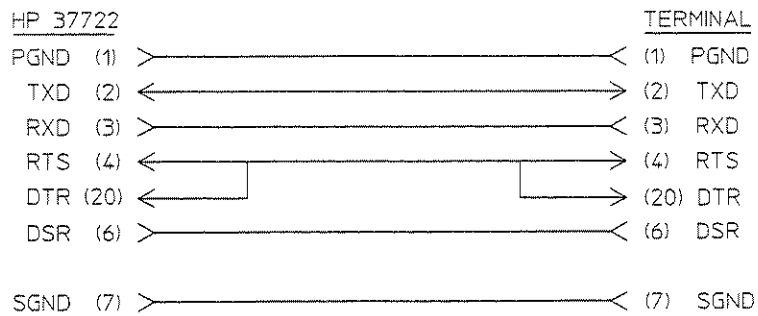

To Set the Analyzer for Operation from a Terminal

Press **OTHER**

Select **RS232 PORT**

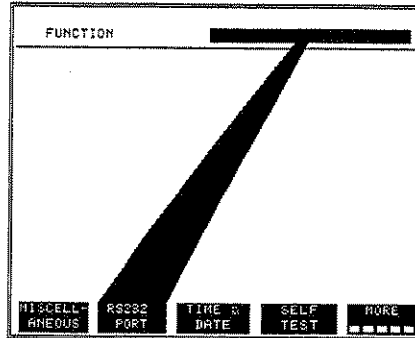

Highlight

RS232 []

Select **TERMINAL CONTROL**

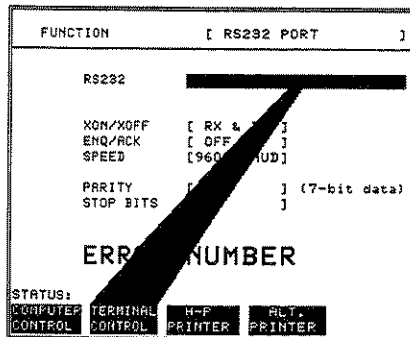

To Set the Analyzer for Operation from a Computer

Press **OTHER**

Select **RS232 PORT**

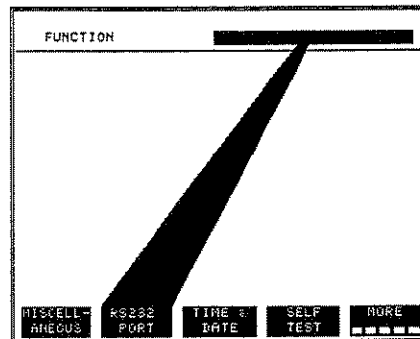

Highlight

RS232 []

Select **COMPUTER CONTROL**

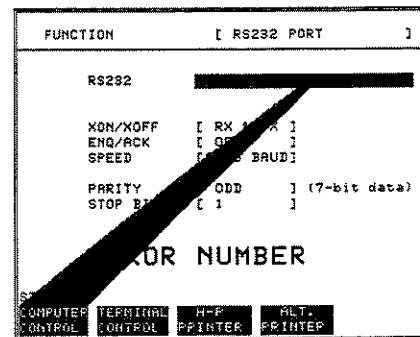

Remote Operation

The following information assumes the user is familiar with the local operation of the analyzer.

Remote operation is performed by a computer or "dumb" terminal connected to the RS-232 port on the side of the analyzer. This port is also used as the printer output port. The printing of results may be performed by returning the results to the computer or printing terminal, or alternatively by storing them in the analyzer for printing at a later time.

The analyzer is operated by commands which are listed later in this chapter. Commands are shown in the actual form required and are presented in "computer type" for example the command for starting a test is shown as STR.

Many commands must be qualified with a variable for example the command COD which selects the ternary line code as has a qualifier *n* which specifies the type of line code HDB3 or AMI.

The qualifier *n* is presented in italic type.

The preferred form of the complete command has a space between the mnemonic and the variable. For example COD 1 is preferred to COD1.

The possible alternative values for *n* are presented as a list. There is usually a choice in the form of the variable, a digit or an alpha-numeric code.

The command information for setting the line code to HDB3 or AMI is presented in the following form:

COD <i>n</i>	<i>n</i> = 1 or HDB3	HDB3 coding
	2 or AMI	AMI coding

To set the code to HDB3 send: COD 1 or COD HDB3

To set the code to AMI send: COD 2 or COD AMI

A space between the mnemonic part of the command (COD) and the variable (*n*) is desirable.

In local operation, all of the front panel controls are responsive and control the analyzer. In remote operation the controls which change parameters are inoperative, the analyzer being controlled by the remote controller. The front panel display reflects the remote programming commands received.

9-6 Remote Control

At power on the analyzer assumes the local state. Under local control all remote commands will be ignored. To gain control of the analyzer the controller must put the analyzer into the remote state. This is accomplished by sending the “remote control enable” command (RMT). The analyzer can be returned to local control by sending the “return to local” command (LCL), or by power cycling the instrument.

Commands are normally separated by “newlines” which can be either a single carriage return character or a carriage return-line feed pair.

Note that line feeds are always ignored in input. It is possible to put multiple commands on one line by separating them with semicolons. Output lines are always separated by carriage return-line feed pairs, regardless of which separator was used on input. This is different to “computer mode”, where the separator used for output is always the same as was used for input.

The length of an input line is limited to 80 characters. If the user tries to type more than 78 characters (the last two are used to store the CR LF), the terminal bell rings and the extra characters are discarded.

Terminal Control

In general this chapter describes how to control the analyzer under computer control. The differences when using a terminal are given here.

The operational differences with terminal use are :

- Characters typed are echoed to the terminal.
- The analyzer provides a prompt at the beginning of the command line.
- Rudimentary input editing (backspace, erase line) is provided.
- An asynchronous interrupt (quit) is provided.
- Errors are reported as text messages.
- A command history is provided.
- Status bit queries indicate active bits in mnemonic form.
- Queries of instrument configuration will return text values.

Prompting and Input Editing

The Prompt

With terminal operation, the analyzer provides a prompt which is displayed on the terminal screen. This prompt may be customized by the user using the ID command. The preset prompt is:

```
HP37722A>
```

Input Editing

There are three special function characters used for input editing :

- BACKSPACE** This character (DELETE) causes the last character typed to be erased (the analyzer outputs BACKSPACE-SPACE-BACKSPACE). If the user attempts to backspace over the prompt, the terminal bell rings.
- KILL** This character (control-U) causes all of the line from the prompt to the end to be erased.
- INTERRUPT** This character (control-C) interrupts the execution of the current command and the analyzer outputs a newline followed by a prompt. Pressing **BREAK** has the same effect.

Error Reporting

When using "computer" mode, errors in parsing or execution cause the processing of the current command to cease, and an error code describing the nature of the problem is placed in the error register, which the user can examine by issuing the ERR? command. In "dumb terminal" mode, the analyzer reports errors when they occur, without the user performing any special action. When an error occurs, the analyzer will echo the faulty command with a text message explaining what the problem was.

Examples :

Example 1 : IDX? sent instead of ID?.

```
HP37722A> idx?  
idx? : Command header error
```

9-8 Remote Control

Example 2 : A command sent when the analyzer was not under remote control.

```
HP37722A> rst
rst : Command not executable in local mode
```

Example 3 : A mixture of valid and invalid commands sent.

```
HP37722A> id? ; idx?
HP37722A
idx? : Command header error
HP37722A>
```

In the third example above, a line contains one legal command (id?), and one illegal command (idx?). The legal command is executed, and the response written to the terminal, followed by an error message for the illegal command.

Note that in “dumb terminal” mode, the analyzer error register is NOT updated. This is because the analyzer effectively follows each error with an internal ERR? rst command, which has the effect of clearing the error register.

Mnemonic Responses

When in “computer mode”, commands which query analyzer status registers (e.g. STA?,RQS? etc.) simply return integers. Where these registers are really collections of bits, each indicating a separate condition, “dumb terminal” mode will output a mnemonic string indicating which bits are active, in addition to the integer value of the register.

Example

```
HP37722A> sta?
28 <RDY LCL FPS>
```

In addition to mnemonic responses for status register queries, “dumb terminal” mode has the facility to return mnemonic responses to selectable variable queries.

Example

```
HP37722A> cod?
HDB3
```

“dumb terminal” mode also provides a command history feature. The analyzer maintains a buffer of up to 20 commands (or 200 characters, whichever runs

out first) of commands entered. Commands are entered into the history buffer whether legal or not, and a command is only not put into the history if it is exactly the same as the last command sent. If there is no space in the history store when a new command is received, commands are deleted from the store, oldest first, until there is enough space.

Commands are provided to list the contents of the store, re-execute the last command sent and to re-execute a particular command, specified by its number. These commands are not themselves placed into the history store.

!1 : Lists the contents of the history store (if any).

NOTE : The character 1 in this command must be the lower case of character L.

Example : Response to a request to list the contents of the history store !1

```
HP37722A> !!
1 : sta?
2 : rst
3 : id?
4 : str
5 : stp
HP37722A>
```

!! : Echoes and re-executes the last command in the history store.

Example : To re-execute the last command.

The last command in the previous example was stp.

Typing !! after the prompt will cause the STOP command to be returned to the terminal and re-executed.

```
HP37722> !!
stp
```

! n : Echoes and re-executes command number n in the history store.

The command number is either the number given by the “!l” command, or a negative number indicating the “second from last (-2)” etc. If the selected command is not in the store the command is echoed and an error message is written to the terminal.

The following errors can occur when using history commands :

9-10 Remote Control

bad history command -- unrecognized history command.

no such history command -- the specified command is not in the store.

HP-IB Operation (option H02)

The standard Telecom / Datacom Testers are provided with RS-232 printer output and remote control.

The special option H02 instruments are provided with Hewlett-Packard Interface Bus (HP-IB) printer output and remote control.

The printing and control information, including commands, in this manual, apply to both RS-232 and HP-IB. The variations in setting up the instrument for HP-IB operation are given in the following pages.

HP-IB Provides a parallel interface which allows the instrument to be incorporated into a system by the connection of other devices, for example : a Personal Computer or a Printer. Such a system allows great flexibility in communicating and controlling data.

The performance of the instrument may be extended by storing a greater number of test set-ups in the controller (or on disc) and loading them into the instrument as required. Similarly a greater number of results may be returned to the controller or printer for later analysis.

If long distance communication is required, suitable HP-IB Extenders are available. HP-IB Extenders are connected within the test system at both ends of the communication link.

Connecting to the HP-IB

The following points should be considered when connecting the instrument to the HP-IB :

- Operating distances
- Communication with the system controller

Operating Distances

To achieve interface design performance standards, restrictions are placed on the HP-IB system cable lengths. These restrictions allow the bus interface to maintain correct line voltage levels and timing relationships.

When connecting an HP-IB system the following rules should be observed :-

1. The total length of HP-IB cable must not exceed 2 meters (6 feet) × the number of devices in the system.
2. The total length of HP-IB cable, used to interconnect all devices in the system, must not exceed 20 meters (65 feet).

Hewlett-Packard Interface Bus Connector

A standard HP-IB connector is provided on the instrument rear panel. The connections and HP-IB logic levels are shown in the following figure. The Mating connector part number is HP 1251-0293 or Amphenol 57-30240.

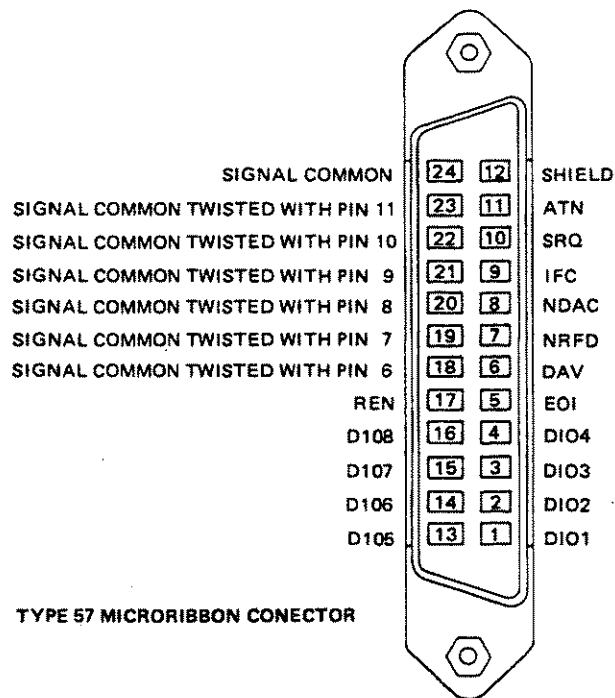

HP-IB Connections and Logic Levels

Suitable Cables

The instrument may be connected to the HP-IB with one of the following HP-IB cables.

Table 9-1. HP-IB Interconnecting Cables

Length	Accessory Number
1 meter	10833A
2 meters	10833B
4 meters	10833C
0.5 meter	10833D

Connection Over Greater Distances

Operating distances can be increased by using HP-IB Extenders, HP 37204A or HP 37201A :

Up to 1250 meters use HP 37204A.

Over 1250 meters use two HP 37201A and two suitable Modems.

Setting Up for Printing or Controlling

A printout of alarms, results and instrument settings may be obtained by connecting a printer to the HP-IB connector and selecting the TALK ONLY mode of operation.

Instrument/system control may be obtained by connecting a controller to the HP-IB connector and selecting the ADDRESSABLE mode of operation.

To Print using Talk Only

Press **OTHER**

Select **HP-IB PORT**

Highlight HP-IB []

Select **TALK ONLY**

Use the information in chapter 6, Printing Results, to set the instrument for the type of print you want.

To Control the Instrument Remotely

Communication with the System Controller

Each device in the system must have a unique address to allow the controller to access it individually. The address is selectable from the instrument front panel.

HP-IB Address Selection

To select the HP-IB address:

Press **OTHER**

Select **HPIB PORT**

Highlight HPIB []

Select **ADDRESSABLE**

Highlight ADDRESS []

Select a "system unique" address in the range 1 to 30

To Return to Local Operation

There are two alternative methods of returning to local operation from remote:

By sending the LCL command

By selecting **OTHER**, **HPIB PORT**, RETURN TO **LOCAL**

Status Reporting

The instruments contains 5 Registers which can be interrogated for status information. Two Status registers, A and B, Alarm register, Ready register and Error register.

To determine the current status of the instrument you must interrogate the Primary Status Byte register, Status register B. Three methods of interrogation are possible via HP-IB but only one method is available via RS-232. The three methods and the remote interface on which they are valid are listed below.

Method of Interrogation	HP-IB	RS-232
Poll using STB?	YES	YES
Repeated Serial Poll (SPOLL)	YES	NO
Poll using a Service Request interrupt routine	YES	NO

Service Request Interrupt Routine

- Select the condition(s), under which you require the instrument to Request Service by using the "RQS n" command.
- Specify the action to be taken when an interrupt is issued by using the controller dependent ENABLE INTR and ON INTR (Basic) statements.
- Acquire the Primary Status Byte using the SPOLL (basic) statement.

The printer/ remote control display used for setting the HP-IB address, gives a service request indication.

Poll Using STB?

- Select the condition(s), under which you require the instrument to Request Service by using the "RQS n" command.
- Enter a waiting loop and acquire the Primary Status Byte by using the "STB?" command.

HP-IB Capability

SH1	(complete capability)
AH1	(complete capability)
T5	(Basic talker, serial poll, talk only mode, unaddress if MLA)
TE0	(No extended talker capability)
L4	(Basic listener, unaddress if MTA)
LE0	(No extended listener capability)
SR1	(Complete SRQ capability)
RL1	(Complete remote-local capability)
PP0	(No parallel poll capability)
DC1	(Complete device clear capability)
DT0	(No device trigger capability)
C0	(No controller capability)

HP-IB Universal Commands

- DEVICE CLEAR
- SELECTIVE DEVICE CLEAR
- INTERFACE CLEAR
- REMOTE ENABLE
- LOCAL
- LOCAL LOCKOUT

Device Clear and Selective Device Clear (SDC)

These commands are usually sent at the beginning of a program to reset the HP-IB interface of the instrument to a known state without changing the panel settings :

- All buffers flushed
- Stop asserting SRQ
- Service request mask set to ERR (32)
- Clear all errors
- Clear status and key registers
- Ready register RAC bit set

Device Clear using an HP 200 series controller is : CLEAR 7 (Where 7 is the Bus I/O select code).

Selective Device Clear using an HP 200 series controller is : CLEAR 705 (Where 7 is the Bus I/O code and 05 is the device address).

Interface Clear (IFC)

This command clears the HP-IB interface and returns the instrument to the listener idle state; it does not affect the parser or any of the internal buffers of the instrument.

Instrument Clear command using an HP series 200 controller is : ABORT 7
(Where 7 is the Bus I/O select code).

Remote Enable (REN)

The Remote Enable command instructs the instrument to accept instruction via the HP-IB. The instrument will accept commands while in local mode only if they do not change the configuration of the instrument. When the instrument receives the remote enable command, the front panel REMOTE indicator comes on.

It is highly recommended that the instrument be put into the remote with local lockout state (RWLS) when being controlled via the HP-IB. This will disable the front panel LOCAL selection and guarantee that the system controller has sole control of the instrument at all times. To do this the controller should send the REN command followed by the LLO command.

When in RWLS, selecting **OTHER**, **HP-IB PORT**, **RETURN TO LOCAL** will cause bit 2 (FPS) of the status byte to be set, generating an SRQ if the SRQ mask is enabled. It is then at the discretion of the controller whether to return the instrument to local control or ignore the request.

Local (LCL)

The instrument can be returned to the local state from the remote state by selecting **OTHER**, **HP-IB PORT**, **RETURN TO LOCAL**, or by sending the LCL command from the controller.

Local command using an HP series 200 controller is : LOCAL 705 (Where 7 is the Bus I/O select code and 05 is the device address).

The Local command (LCL) overrides Local Lockout.

Programming Tips

The graphics page is very CPU intensive. If the instrument is operated under remote control while displaying graphs, then these remote control functions may take a considerable time to execute, e.g. 10s for RST.

The hardware may require a settling time after receiving configuration commands. For example, if the instrument is in a production test environment then use can be made of the alarm register to determine when the instrument hardware has fully settled.

It should be noted that users rapidly polling registers during certain instrument functions, such as self-test, auto-setup or printing, can expect these functions to slow significantly in their execution as the remote control interface has a priority response time over these functions. It is recommended that a delay of 100ms always be placed between successive polls.

There are three flags associated with various registers in the instrument which are related to the start/stop testing function. These are the TIP, EOT and OST flags of status register-A and the ready register respectively. The TIP flag behaves as a gate to prevent controllers so programmed from attempting to change instrument configuration. It is set immediately on receipt of a STR command and cleared a short time after receipt of a STP command once all results are calculated and the instrument has settled. The EOT flag is similar in scope to TIP except that it is cleared on receipt of STR and set once the results are available but cleared again when a result is queried. The OST flag can be thought of as a hardware gate in that it gets set when the instrument counters are actually accumulating results. This usually occurs a short time after receipt of the STR command. The bit is cleared as soon as the instrument counters are no longer accumulating data.

Visually:

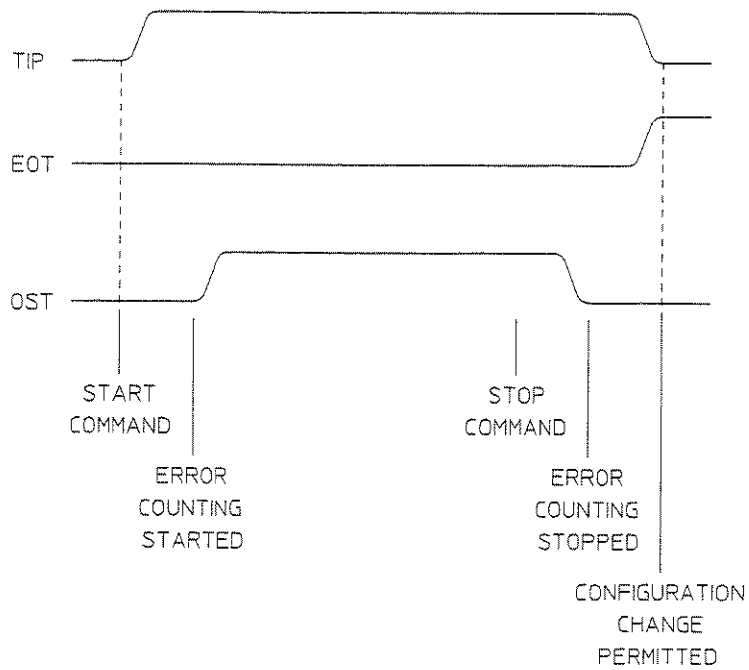

9-20 Remote Control

THE COMMANDS

COMMON CAPABILITY COMMANDS

Reset

The reset action message presets the instrument to its default state. A full listing of this default state is given in Default Conditions. The predefined default state is as follows:

- Configuration defined by stored setting 0
- Stopped testing, self-testing, printing and autosetup
- All buffers flushed
- Stop asserting SRQ (HP-IB versions)
- Service request mask set to ERR (HP-IB versions)
- Clear all errors
- Clear status, alarm mask and key registers
- Ready register set to RAC, ASC, STC and LQE (not RAC in TERMINAL CONTROL)

The remote control parser and executor are also reset.

RST

Self-test

The self-test command instructs the instrument to perform a selected self-test. Testing runs until completion or stops at the first test to fail. On test completion a subsequent response of 0 to ERR? indicates that the test has passed, any other number indicates a failure, (see service manual for a full list of self-test error codes). Self-test progress can be monitored by polling the STC bit in the ready register. TEST12 is only available when Option 005 or 006 is fitted.

TST <i>n</i>	<i>n</i> =	0 or ALL	All tests
		1 or TEST1	CPU test
		2 or TEST2	Pattern test
		3 or TEST3	Frame test
		4 or TEST4	Line code test
		5 or TEST5	Timeslot test
		6 or TEST6	Error add test
		7 or TEST7	Frame error test
		8 or TEST8	Alarms test
		9 or TEST9	Signal test
		10 or TEST10	Bit test
		11 or TEST11	Clock recovery test
		12 or TEST12	Option 005/006 test

Remote

This command causes the instrument to go remote with local lockout. (This is functionally equivalent to the \$REN+\$LLO meta message used in HP-IB interfaces).

RMT

Local

This command causes the instrument to clear local lockout and return to local. (This is functionally equivalent to the clear \$LLO and \$RTL meta message used in HP-IB interfaces).

LCL

Clear

This command clears all instrument errors and flushes all buffers without affecting the programmed state of the instrument. (This is functionally equivalent to the \$DCL or \$SDC meta messages used in HP-IB interfaces). The following things are performed by executing this command:

- All buffers flushed except printer output
- Stop asserting SRQ (HP-IB versions)
- Service request mask set to ERR

9-22 Remote Control

- Clear all errors
- Clear status, alarm mask and key registers
- Ready register RAC set (not in RS-232 terminal control)

The command is as follows:-

CLR

Configuration

This command takes as its parameter a block of data which specifies the instrument's internal setup state. The block is a IEEE Std 728 #H format. This is intended only for restoring an instrument state saved using CON? and hence its internal format is not elaborated upon.

NOTE: This command does not record the settings of remote control sources, or current states of remote control registers. It is equivalent in scope to store/recall stored settings. One block should not be compared with another in a comparison attempt as redundant but variable information is also included in the block.

CON #H where #H = IEEE Std 728 "#H" block of data

The complement of this command is used to enquire about the configuration of the instrument; it returns the configuration of the instrument in exactly the same form, namely the IEEE Std 728 #H data block. The length of the block will not exceed 2500 characters.

CON? returns #H

Key Query

This command returns the value of the last key pressed on the front panel. The value is returned as an integer whose meaning is given below. If no key was pressed since the last time the command was used, 0 is returned.

Note that this command does not wait until a key is pressed. Using this command clears the key register to 0 and clears FPS in status registers A & B.

KEY? returns

- 1 = Cursor Up
- 2 = Cursor Down
- 3 = Softkey-1
- 4 = Softkey-2
- 5 = Softkey-3
- 6 = Softkey-4
- 7 = Softkey-5
- 8 = Settings
- 9 = Results
- 10 = Other
- 11 = Graph
- 12 = (unused)
- 13 = Auto Setup
- 14 = Show History
- 15 = Key Release
- 16 = Push To Talk
- 17 = Volume Lower
- 18 = Volume Raise
- 19 = Run/Stop
- 20 = Print Now
- 21 = Reset History
- 22 = Single

$n = 1$ to 22

Request Service Mask

This command is used to enable or disable the source for setting the RQS bit in status registers A and B. It takes as a parameter a 16-bit integer which is used to mask the various causes for the setting of this bit. Associated with status register A is a mask which enables or disables the various sources of setting the RQS bit (ie only the positive edge of a bit in status register A with it's corresponding mask bit enabled will cause the RQS bit to be set.) It is this mask which the Request Service command addresses. (In instruments with HP-IB this command sets/clears the sources for SRQ).

RQS returns n where $n = 0$ to 30719

The mask has an identical bit map as status register A and can be set in three different ways.

9-24 Remote Control

- 1) The parameter can be a single 16 bit integer, corresponding to the addition of binary weighted bits wishing to be enabled, e.g. if we wished to enable EOT and ERR then the command would be:-

RQS 288

- 2) The parameter can be a list of the binary weighted integers corresponding to all those sources wishing to be enabled separated by commas, e.g. if we wished to enable EOT, FPS and ERR then the command would be:-

RQS 256,4,32

- 3) The parameter can be a list of three letter mnemonics defined in Status Registers, separated by commas, e.g. if we wished to enable ERR, RDY and LCL then the command would be:-

RQS ERR,RDY,LCL

As well as the three methods of passing the parameter outlined above, any combination may be used, remembering that the result is always evaluated to a 16 bit integer. Care should be taken to ensure the resultant integer is in range and the desired sources are enabled. (Although range checking is done, no checking of constituent parameters is performed to ensure that they are binary values). There are two other special parameters to this command. They are RQS ON and RQS OFF. RQS OFF is not equivalent to RQS 0 because the former disables all reasons for setting the RQS bit (status-A) but remembers the stored mask. Upon receipt of the RQS ON command, service requests will be enabled again with the same mask as before (NOTE any positive edges of sources with their mask set should be caught, so that they will set the RQS bit when the RQS ON command is sent). If the RQS ON command is sent without a corresponding RQS OFF command sent before it, the instrument shall assume the RQS ERR state as a default.

The complement of this command is used to inspect the Service Request Mask. The command responds with a 16 bit integer equivalent to the binary weighted values of those sources which are enabled (outlined in Status Registers).

RQS? returns n where $n = 0$ to 30719

Instrument Identification

This command programs the identification for the instrument. This is included to be compatible with "common capabilities" and as a standard response.

The identification appears on printed output and on the stored measurement page and as a prompt in TERMINAL CONTROL. The string is stored in the instruments EEPROM and will be remembered through power fails and stored settings events. No difference in function can be inferred from the two possible responses, i.e. A HP 37732A can have the same functionality as a HP 37722A if the accessory is disconnected.

ID *n* *n* = 1 or HP 37722A
 2 or HP 37732A

The corresponding query command ID? returns HP37722A or HP37732A

Revision Date Query

This command is a request for the instruments firmware revision date and the latest applicable Codes and Formats document (HP728) and Capabilities document to which the instrument was designed. The instrument returns two four digit date codes separated by a comma, these date codes are in standard HP serial number format (a four digit code, where the first two digits indicate the year (from 1960) and the next two indicate the week (01 to 52)). The firmware revision date comes first, followed by the Codes and Formats date.

REV? returns *dddd,2332* where *dddd* = Firmware date code.

Serial Number Query

This command is a request for the instrument to return it's individually assigned serial number.

SER? returns *ddddUnnnnn*

Error Code Query

This command is a request to read the instrument's error register. The error register contains an integer in the range -32768 to 32767. The error codes have various meanings, some defined by "common capabilities" and some instrument dependent (see Error Codes for a full listing). If no error exists at the time of enquiry, then 0 is returned. The error register is cleared on reading the register or by sending either the CLR or RST command. The error register will also contain the result of a remotely initiated self-test command. This is also cleared as above.

ERR? returns n where $n = -32768$ to 32767

Ready Code Query

This command is a request to read the instrument's ready register. The result is a binary weighted decimal integer. The meanings of the bits is given in Status Registers.

RDY? returns n where $n = 0$ to 127

Status/Events Query

This command is a request for the instrument to return the contents of status register A. It responds with an integer which represents the 16 bit binary weighted contents of the status register bits. A detailed description of status register A is given in Status Registers.

STA? returns n where $n = 0$ to 30719

Status Query

This command is a request for the instrument to return the contents of status register B. It responds with an integer which represents the 8 bit binary weighted contents of the status register bits. The act of executing this command also clears the RQS bit in status registers A and B, (similar to the serial poll of HP-IB interfaces). A detailed description of status register B is given in The Status Register part of this chapter.

STB? returns n where $n = 0$ to 255

Options Query

This command is a request for the instrument to return its options. The result returned is a decimal weighted integer corresponding to the options fitted.

OPT? returns n where $n = 0$ to 11111111 : Coded as below.

Number	Option Fitted
1	OPT-001 T/S Access (Obsolete)
10	OPT-002 8 Mb/s
100	OPT-003 704 kb/s
1000	OPT-005 T/S Access+Sub Rate+Tones
10000	OPT-006 T/S Access+Tones
100000	OPT-V01 Virtual Remote
1000000	OPT-210 Enhanced M.21XX features
10000000	OPT-010 Relative Frequency

INSTRUMENT SETTINGS COMMANDS

Application Mode

Selects the application for the instrument. The application choices govern the main configuration for the instrument. Applications involving 704 kb/s, 8 Mb/s, timeslot access (also known as drop & insert), sub rate and tones are dependent on those options being fitted. An error code appropriate to the missing option may be generated if an attempt is made to set up the corresponding application. Reference should be made to the MODE command for accessory applications.

APP <i>n</i>	<i>n</i> = 1 or M2M	2 Mb/s
	2 or M704K	704 kb/s
	3 or MSM	8 Mb/s
	4 or M64K	64 kb/s
	5 or M2MFMSIM	2 Mb/s Frame Simulate
	6 or M2MDI	2 Mb/s Ext Drop + Insert
	7 or M704KFMSIM	704 kb/s Frame Simulate
	8 or M704KDI	704 kb/s Ext Drop + Insert
	9 or M2MTR	2 Mb/s Tx, 64 kb/s Rx
	10 or M64KTR	64 kb/s Tx, 2 Mb/s Rx
	11 or SUBRATE	Sub rate (X.50/X.58)
	12 or TONES	Tone generation and meas

APP? returns *n* where *n* = 1 to 12

Interface Type

Selects the Tx and Rx hardware interface. Some application modes have fixed interfaces. The CODIREctional interface is the only one available for the 64 kb/s application, the CODTERN choice is the only one available for application 64 kb/s Tx & 2 Mb/s Rx (and the converse application 2 Mb/s Tx & 64 kb/s Rx) and is in fact both the ternary and codirectional interfaces. All other applications have choices of BINARY or TERNARY.

IFC <i>n</i>	<i>n</i> = 1 or TERNARY	Ternary
	2 or BINARY	Binary
	3 or CODIR	Codirectional
	4 or CODTERN	Codirectional & Ternary

IFC? returns *n* where *n* = 1 to 4

Binary Interface Transmit Clock Phase

Selects the binary interface transmit clock polarity.

TCP <i>n</i>	<i>n</i> = 1 or NORMAL
	2 or INVERTED

TCP? returns *n* where *n* = 1 or 2

Binary Interface Receive Clock Phase

Selects the binary interface receive clock polarity.

RCP <i>n</i>	<i>n</i> = 1 or NORMAL
	2 or INVERTED

RCP? returns *n* where *n* = 1 or 2

Ternary Linecode

Selects the line code for ternary interface types.

COD <i>n</i>	<i>n</i> = 1 or HDB3	HDB3 code
	2 or AMI	AMI code

COD? returns *n* where *n* = 1 or 2

Sub Rate Structure

For Option 005 application SUB RATE only. It selects which CCITT sub rate structure will be used for the transmitter and receiver.

SRS <i>n</i>	<i>n</i> = 1 or X50DIV2	X.50 division 2
	2 or X50DIV3	X.50 division 3
	3 or X50BIS	X.50 bis
	4 or X58	X.58
	5 or X58_ETSI	X.58 ETSI
	5 or X58_PTTNL	X.58 ETSI

SRS? returns *n* where *n* = 1 to 4

Sub Rate Bearer Rate

For the sub rate application only. It selects the primary rate which will contain or bear the relevant sub rate structure.

BRR <i>n</i>	<i>n</i> = 1 or F2M	2 Mb/s
	2 or F64K	65 kb/s

BRR? returns *n* where *n* = 1 or 2

Framing Type

Selects the framing type for framed (2 Mb/s, 704 kb/s or 8Mb/s) application choices.

FRM <i>rate,type</i>	<i>rate</i> = 1 or F704K	704 kb/s
	2 or F2M	2 Mb/s
	3 or F8M	8 Mb/s
	<i>type</i> = 0 or OFF	Off
	1 or ON	On (704 kb/s, 8Mb/s)
	1 or CASMFM	CAS MFM (2 Mb/s)
	2 or NOMFM	No MFM
	3 or CASCRC	CAS, CRC4 MFM
	4 or CRCMFM	CRC4 MFM

FRM? <i>rate</i>	<i>rate</i> = 1 or F704K
	2 or F2M
	3 or F8M

Returns *n* = 0 to 4

Through Mode

Selects whether the through mode is enabled or not. Through mode is only applicable to applications 2 Mb/s, 704 kb/s (where fitted) and TONES and when framing is enabled. It is also available for the sub rate application (where fitted), where all except the selected channel/mapping is copied from receiver to transmitter.

THU <i>n</i>	<i>n</i> = 0 or OFF	Through mode off
	1 or ON	Through mode on

THU? returns *n* where *n* = 0 or 1

Transmitter Clock Source

Selects the transmitter clock source. When through mode is offered and enabled the transmitter clock source is the receiver clock. In frame simulate applications the transmitter clock is fixed at INTERNAL. In application 2Mb/s TX 64kb/s RX and for BINARY interfaces, the choice is limited to INTERNAL and EXTERNAL.

TCL <i>n</i>	<i>n</i> = 1 or INTERNAL	Internal clock source
	2 or LOOP	Loop timed clock source
	3 or EXTERNAL	External clock source

TCL? returns *n* where *n* = 1 or 3

Transmitter Octet Timing

Selects octet timing for the 64kbit/s codirectional transmitter. Whenever the receiver is configured for receiving codirectional signals, octet timing will always be sought after and the octet loss alarm will function regardless of the setting of this selection.

TOC <i>n</i>	<i>n</i> = 0 or OFF	Octet timing off
	1 or ON	Octet timing on

TOC? returns *n* where *n* = 0 or 1

9-32 Remote Control

Pattern Type

Selects the pattern to be transmitted and received. For applications 2 Mb/s, 704 kb/s, 8 Mb/s, 64 kb/s, 2 Mb/s TX-64 kb/s RX and 2 Mb/s RX-64 kb/s TX, the pattern set is PRBS23, PRBS15, PRBS11, ONES, ALT, USER and LIVE. With ternary AMI signals PRBS23 is omitted. For application 2 Mb/s LONG user word is added. For application SUB RATE, the pattern set is PRBS11, PRBS9, USER and DATACOM D & I. Pattern LIVE invokes monitor mode where no BER or pattern sync loss measurements are performed. Only code and framing type errors are monitored, where applicable. Pattern DATACOM D & I is used for dropping and inserting sub rate data (OPT-005) to and from the datacom port on the instrument.

PAT <i>n</i>	<i>n</i> = 1 or PRBS23	$2^{23}-1$ prbs
	2 or PRBS15	$2^{15}-1$ prbs
	3 or PRBS11	$2^{11}-1$ prbs
	4 or ONES	1111
	5 or ALT	1010
	6 or USER	User word
	7 or LIVE	Live data
	8 or PRBS9	2^9-1 prbs
	9 or DATACOM	Datacom D & I port
	10 or LONG	Long user word

PAT? returns *n* where *n* = 1 to 10

PRBS Polarity

Selects the polarity of a PRBS pattern. The polarity can be either NORMAL or INVERTED. This selection does not apply to PRBS in the sub rate application. The standard CCITT PRBS polarities are as follows:

PRBS	Polarity	CCITT
$2^{11}-1$	Normal	0.152
$2^{15}-1$	Inverted	0.151
$2^{23}-1$	Inverted	0.151

PPO <i>n</i>	<i>n</i> = 1 or NORM	Normal PRBS polarity
	2 or INV	Inverted PRBS polarity

PPO? returns *n* where *n* = 1 or 2

User Defined Word Pattern

Selects the user defined word pattern as applicable under PAT USER. The parameter passed is a 16-bit binary word as a string in quotes. For Option 005 with sub rate with X.50 type structures, bits 1 and 8 are reserved for framing and appear as "F" on the display although any values of "0", "1" or "F" will be accepted. The query command will return the field as it appears on the display, including any "F" bits.

PAU "*patt*" "*patt*" = 16 characters 0 or 1 Word data

PAU? returns "*patt*" "*patt*" = 16 characters 0 or 1 or F

Sub Rate X.50 Status Bit

Only relevant when Option 005 with sub rate is fitted. It selects the polarity of the status bit (S-bit) as defined for the CCITT X.50 structure. The parameter passed is a 1-bit binary word string, in quotes.

XSB "*bit*" "*patt*" = 1 character 0 or 1

XSB? returns "*bit*" "*patt*" = 1 character 0 or 1

Tone Frequency

Only relevant when Option 005 or 006 is fitted. It selects the fixed value tone frequency which can be inserted into each of from 1 to 31 2 Mb/s timeslots.

TFF <i>n</i>	<i>n</i> = 1 or T404	404 Hz
	2 or T1008	1008 Hz
	3 or T2100	2100 Hz
	4 or T2804	2804 Hz
	5 or USER	User program frequency

TFF? returns *n* where *n* = 1 to 5

User Defined Tone Frequency

Only relevant when Option 005 or 006 is fitted. It selects the user defined tone frequency as applicable under TFF USER.

TFU *n* *freq* =100 to 3900 Frequency in Hz

TFU? returns *freq* where *freq* = 100 to 3900

Tone Level

Only relevant when Option 005 or 006 is fitted. It selects the tone level which can be inserted into each of from 1 to 31 2 Mb/s timeslots. The parameter must be a multiple of 5 dBm0.

TFL *lvl* *lvl* = 0 to -55 dBm0 in 5 dBm0 steps

TFL? returns *lvl* where *lvl* = 0 to -55

Transmitter Multiple Timeslot Selection

This selects the primary transmit timeslots for the 2 Mb/s, 2 Mb/s D & I (multiple insert timeslots), 704 kb/s and TONES applications. It also selects the receiver timeslots when the receiver selection is ASTX.

The parameters correspond to rate and the binary representation of the multiple timeslot selection field. T/S-0 is fixed for framing (F) and if 2 Mb/s and CASMFM or CASCRC4 framing is selected then T/S-16 is reserved for signaling (S). In the latter case, T/S-16 can be set to either "0" or "1". The timeslot is selected (deselected) depending on the corresponding mask element being "1" ("0").

TTM <i>rate</i> , " <i>mask</i> "	<i>rate</i> = 1 or F704K	704 kb/s
	2 or F2M	2 Mb/s
	<i>mask</i> = 31 characters 0 or 1	2 Mb/s mask
	10 characters 0 or 1	704 kb/s mask
TTM? <i>rate</i>	<i>rate</i> = 1 or F704K	
	2 or F2M	
returns " <i>mask</i> "	" <i>mask</i> " = 10 or 31 characters 0 or 1	

Transmit Single Timeslot

Selects the transmit timeslot for the application 2 Mb/s Tx, 64 kb/s Rx. Data is internally generated and injected into the 2 Mb/s transmit timeslot. T/S-16 is reserved for signaling with CAS framing as with all 2 Mb/s timeslot commands.

TTS n $n = 1$ to 31 Transmit timeslot

TTS? returns n where $n = 1$ to 31

Receive Timeslot

This sets up the source of the receiver timeslots in which bit error detection and pattern synchronization takes place for applications using multiple receive timeslots (i.e. 2 Mb/s and 704 kb/s). It also sets the source for drop timeslots in the 2 Mb/s D & I application for $N \times 64$ kb/s. Hence ASTX also means AS PER INSERT for 2 Mb/s D & I. Thus, ASTX means that the receive/drop timeslots will be identical to the transmit/insert timeslots set up.

RXT n $n = 1$ or ASTX Rx uses tx timeslot
2 or SELECT Select tx and rx timeslots

RXT? returns n where $n = 1$ or 2

Receiver Single Timeslot

This sets up the receiver timeslot in which bit error detection and pattern synchronization takes place for the application using single timeslot manipulation in the receiver (i.e. 64 kb/s Tx, 2 Mb/s Rx). It is also the single timeslot where tones measurements are performed in application TONES, (options 005/006). Note that timeslot-16 is not permitted for 2 Mb/s CAS framing as this is dedicated to signaling.

RTS n $n = 1$ to 31 Timeslot number (2 Mb/s)

RTS? n where $n = 1$ to 31

Receiver Multiple Timeslot Selection

This sets up the receive/drop timeslots for applications using multiple timeslot manipulation in the receiver, i.e. 2 Mb/s, 2 Mb/s D & I (multiple drop timeslots) and 704 kb/s. This also affects pattern sync detection and bit error rate measurement in the case of 2 Mb/s and 704 kb/s. The parameters correspond to rate and the binary representation of the multiple timeslot selection field. T/S-0 is fixed for framing (F) and if a 2 Mb/s rate and CASMFm or CASCRc4 framing is selected then T/S-16 is reserved for signaling (S). In the latter case, T/S-16 should be set to "0". Timeslot n is selected (deselected) depending on the corresponding mask bit being "1" ("0").

RTM rate, "mask"	rate = 1 or F704K	704 kb/s
	2 or F2M	2 Mb/s
	mask = 31 characters 0 or 1	2 Mb/s mask
	10 characters 0 or 1	704 kb/s mask

RTM? rate	rate = 1 or F704K	704 kb/s	2
	2 or F2M	Mb/s	
returns "mask"	"mask" = 10 or 31 characters	0 or 1	

Sub Rate Bearer Timeslot

For the sub rate application only (where fitted). It selects the 2 Mb/s bearer timeslot within which the sub rate structure is contained. The timeslot numbering is as per similar single timeslot fields in the instrument in that T/S-16 is reserved for signaling with CAS framing types.

SRT n	$n = 1$ to 31	2 Mb/s timeslot number
---------	---------------	------------------------

SRT? returns n where $n = 1$ to 31

Sub Rate Channel Number

For the sub rate application only (where fitted). It selects the channel number for structures X.50 div 2, X.50 div 3 and X.58. The parameter is as defined by CCITT X.53 with further provision for X.58 and is always a four digit integer. The most significant digit has value 1 for X.50 div 2, value 2 for X.50 div 3 and value 3 for X.58. The second digit takes on a value in the range 3 to 8 with

exceptions for each structure and the third and fourth digits have values of 01 to 80 with exceptions dependent upon the first and second digits. The full exception table is large and can be found in the instrument specification.

CCN *n* *n* = 1301 to 3804 Channel number

CCN? returns *n* where *n* = 1301 to 3804

External Drop + Insert Data Source

This command only applies to applications which use the timeslot access option (also known as drop & insert). This command selects from/to which interface the required data is to be dropped/inserted from/to. For example, the data could come from the datacom interface and be inserted into a timeslot while data is dropped from another or the same timeslot back down the datacom interface.

EDI *n* *n* = 1 or DATACOM X.21 datacom channel
 2 or AUDIO 600Ω audio port

EDI? returns *n* where *n* = 1 or 2

Data Insert To Timeslot

This command only applies to applications which use the timeslot access option (also known as drop & insert) and selects to which timeslot the required data (from the EDI command) is to be inserted to. For 2 Mb/s D & I only, this selection inserts to the 600 Ω audio channel. When inserting to the datacom port, the N x 64 kb/s selection TTM must be used.

The timeslot number is preserved through change of rate/application and so a rate parameter is used as a pointer to which timeslot number is specified. Note that the limitations of timeslot number selection for 2 Mb/s are as per the RTS command.

DIT <i>rate,n</i>	<i>rate</i> = 1 or F704K	704 kb/s
	2 or F2M	2 Mb/s
	<i>n</i> = 1 to 10	704 kb/s timeslot number
	1 to 31	2 Mb/s timeslot number

DIT? <i>rate</i>	<i>rate</i> = 1 or F704K
	2 or F2M
returns " <i>n</i> "	<i>n</i> = 1 to 10
	1 to 31

Data Insert Timeslot Enable

This command only applies to applications which use the timeslot access option (also known as drop & insert), and controls data insertion into the timeslot(s) selected by the DIT or TTM commands.

DIE <i>n</i>	<i>n</i> = 0 or OFF	Insert Off
	1 or ON	Insert On

DIE? returns *n* where *n* = 0 or 1

Data Drop From Timeslot

This command only applies to applications which use the timeslot access option (also known as drop & insert) and selects to which timeslot the required data (from the EDI command) is to be dropped from. For 2 Mb/s D & I only, this selection drops to the 600 Ω audio channel. When dropping to the datacom port, the N x 64 kb/s selection RTM must be used.

The timeslot number is preserved through change of rate/application and so a rate parameter is used as a pointer to which timeslot number is specified. Note that the limitations of timeslot number selection for 2 Mb/s are as per the RTS command.

DFT <i>rate,n</i>	<i>rate</i> = 1 or F704K	704 kb/s
	2 or F2M	2 Mb/s
	<i>n</i> = 1 to 10	704 kb/s timeslot number
	1 to 31	2 Mb/s timeslot number

Speaker Enable

This command only applies to applications which use the timeslot access options. Its function is twofold.

When used with either 2 Mb/s or 704 kb/s applications and timeslot monitor is selected, then speaker ON will provide an audible representation of the selected timeslot. The same is true for the TONES application.

When used with either 2 Mb/s or 704 kb/s drop and insert applications, (single timeslots only), then an audible representation of the dropped timeslot is provided. Further, this will also enable the PUSH-TO-TALK key to insert voice data into the insert timeslot.

The speaker control field is forced to OFF outwith the above applications.

SPK <i>n</i>	<i>n</i> = 0 or OFF	Speaker Off
	1 or ON	Speaker On

SPK? returns *n* where *n* = 0 or 1

M.2110 limits

This command allows access to the performance limits against which the M.2110 test is to be run. The values are derived using the Path Allocation as a scaling factor for the Reference Performance Objective (see "MPA" command).

The syntax is:

L2110? *duration,result*

<i>duration</i> = 1 or DAY	1 day test
2 or WEEK	1 week test
<i>result</i> = 1 or S1ES	Errored seconds exceeding the S1 threshold
2 or S2ES	Errored seconds exceeding the S2 threshold
3 or S1SES	Severely errored seconds exceeding the S1 threshold
4 or S2SES	Severely errored seconds exceeding the S2 threshold

Returns:-

"*n*" "*n*" = 0 to 9999

M.2120 limits

This command allows access to the performance limits against which the M.2120 test is to be run. The values are derived from the Reference Performance Objective (see "RPO" command). TR1 is a 15 minute period and TR2 is a 24 hour period.

The syntax is:

```
L2120? duration,result  duration = 1 or TR1  15 minute period
                               2 or TR2    24 hour period
                               result = 1 or ES  Errored seconds
                               2 or SES    Severely errored seconds
```

Returns:-

"n" "n" = 0 to 9999

Set M.21XX Path Allocation

This command sets the path allocation percentage which is used to determine limits for M.2110 and M.2120 tests.

```
MPA percent            percent = 0.5 to 40.0    in 0.5% steps
```

MPA? returns *percent* where *percent* = 0.5 to 40.0

Set pattern loss threshold

This command allows selection of PRBS pattern loss criterion, between the original version (1 deci-second @ BER > 20%) and the newer CCITT O.151 compatible one (10 consecutive deciseconds @ BER > 10%).

```
PLS n            n = 1 or STANDARD  BER > 20% for more than 1 deci-second
                               2 or O151      BER > 10% for 10 consecutive deci-seconds
```

PLS? returns *n* where *n* = 1 or 2

Stored Path Allocation

Query a particular store for the Path Allocation; the results correspond to the MPA? command.

SMPA? *n* *n* = 0 to 9 Store number

Stored M.2100 Limits Query

Query a particular store for the M.2100 limits; the results correspond to the L2100? command.

SL2100? *n* *n* = 0 to 9 Store number

OTHER-PAGE FUNCTIONS

The following set of commands relate to the fields found on the OTHER pages of the instrument.

Save Settings

This command instructs the instrument to save its current configuration in one of the stored setting locations. They are numbered 1 thru 5. This function may be prevented if the settings lock is enabled.

SAV n where $n = 1$ to 5

Recall Settings

This command instructs the instrument to configure itself as defined in one of the stored settings locations, dependent upon the associated parameter. Recalling stored setting 0 will reset the instrument to its default settings (see Default Conditions). Stored setting lock has no effect on recalling settings.

RCL n where $n = 0$ to 5

Settings Lock

This command locks all of the instruments stored settings such that they cannot be overwritten by new settings. This does not prevent the recalling of previously stored settings.

SLK n $n = 0$ or OFF Off
 1 or ON On

The complementary command returns the current settings lock status in integer form as described above.

SLK? returns n where $n = 0$ or 1

Name Stored Setting

This command permits stored settings 1-5 to be named by a string of up to 32 characters. Not all of the character positions need be filled and any ASCII character is permitted including control characters. (This may cause problems for RS-232 operation). Note: either single or double quotes around the string

9-44 Remote Control

DAT? returns *years,months,days*

Time Set-Up

This sets the real time for the instrument in terms of hours, minutes, and seconds.

This command is equivalent to selecting the Time field on the TIME AND DATE page of the instrument. On completion of the command, the time will be installed and the real time clock will be running.

TIM *hours,mins,secs* *hours* = 0 to 23
 mins = 0 to 59
 secs = 0 to 59

The complementary command returns the time in integer form as shown above.

TIM? returns *hours,mins,secs*

Keyboard Lock

This command enables or disables the keyboard lock. When locked all keys, other than page or cursor movement, become inactive.

KLK *n* *n* = 0 or OFF Keyboard lock disable
 1 or ON Keyboard lock enable

KLK? returns *n* where *n* = 0 or 1

External RS-232 Printer Set-Up

This command configures the RS-232 Port external printer settings. Fixed parameters include parity none hence 8-bit data. As there is only one RS-232 port in this instrument, the printer port will be unavailable while RS-232 remote control is in use.

PTR *baud_rate,stop_bits,protocol,print_style*

<i>baud_rate</i> =	1 or 300	300bd
	2 or 600	600bd
	3 or 1200	1200bd
	4 or 1800	1800bd
	5 or 2400	2400bd
	6 or 4800	4800bd
	7 or 9600	9600bd
<i>stop_bits</i> =	1 or ONE	One stop bit
	2 or TWO	Two stop bits
<i>protocol</i> =	0 or OFF	No handshake
	1 or ENQACK	Enq/Ack handshake
	2 or XONXOFF	Xon/Xoff handshake
	3 or DTR	DTR handshake
<i>print_style</i> =	1 or COMPRESSED	Compress print style
	2 or NORMAL	Normal print style

PTR? returns *baud_rate,stop_bits,protocol,print_style*

Audio Source (Beep On Error)

This command selects the beep on error source for the audio output. All selections are always available even though they may be out of context with the instrument's current settings.

AUS <i>n</i>	<i>n</i> = 0 or OFF	Off
	1 or BIT	Bit Errors
	2 or CODE	Code Errors
	3 or FRAME	Frame Errors
	4 or CRC	CRC Errors
	5 or REBE	REBE Errors
	6 or ALL	All error sources

The complementary command returns the error source for the audio output, in integer form as shown above.

AUS? returns *n* where *n* = 0 to 6

Long User Word Selection Number

This command selects which long user word pattern, from a choice of four, is to be transmitted and received by the instrument when the appropriate pattern choice is made (PAT command).

LUS *n* *n* = 1 to 4 Long user word pattern

LUS? returns *n* where *n* = 1 to 4

Long User Word Byte Length

This command selects which long user word byte length for one of the four long user words. Parameter one relates to which long user word selection number is being addressed. As a word reduces in length, the unused bytes will be removed from the right hand side of the word. Subsequent increases in length will restore those previously hidden bytes.

LUL *n,length* *n* = 1 to 4 Long user word pattern
 length = 1 to 128 Byte length for word *n*

LUL? *n* *n* = 1 to 4

Returns:-

length *length* = 1 to 128

Long User Word Pattern Synchronisation Length

This command selects the long user word pattern synchronisation byte length for one of the four long user words. Parameter one relates to which long user word selection number is being addressed. The sync length is either the FULL length of the word or it can be programmed to a desired USER value.

<i>LUY n, sync</i>	<i>n = 1 to 4</i>	Long user word pattern
	<i>sync = 1 or FULL</i>	Full length pattern sync
	<i>2 or USER</i>	User program length pattern sync

LUY? n *n = 1 to 4*

Returns:-

sync *sync = 1 or 2*

Long User Word User Program Synchronisation Length

This command selects the long user word pattern synchronisation byte length for one of the four long user words. Parameter one relates to which long user word selection number is being addressed and parameter two is the user programmable synchronisation length. The sync length must be less than or equal to the word length. An error will be reported if an attempt is made to do otherwise.

<i>LSL n, length</i>	<i>n = 1 to 4</i>	Long user word number
	<i>length = 1 to 128</i>	Sync length for word <i>n</i>

LSL? n *n = 1 to 4*

Returns:-

length *length = 1 to 128*

Printer auto trigger

This command allows setting of the instrument to print its measurement results at a 15-minute or a 1-hour or a 24-hour interval.

PRA <i>n</i>	<i>n</i> = 0 or OFF	Auto trigger off
	1 or FIFTEENMIN	Print at 15 minute intervals
	2 or ONEHOUR	Print at 1 hour intervals
	3 or ONEDAY	Print at 1 day intervals

PRA? returns *n* where *n* = 0 to 3

KEYBOARD FUNCTION SETTINGS COMMANDS

This section contains those commands which execute various functions as a result of a keypress.

Receiver Auto-Setup

This command will initiate the receiver to perform an auto-setup. The auto-setup cannot occur while the instrument is testing or self-testing, or in frame simulation application modes which are primarily transmitter functions. The progress of the auto-setup can be monitored by following the ready register ASC bit.

AUT

Start Testing

This command causes the instrument to start testing, the type of test period being defined by the TTY command. This command is always valid, and clears all error counters before commencing. This command is equivalent to pressing the Start/Stop key on the front panel when not testing.

STR

Notes:

There can be a delay of up to 400ms between the execution of this command and the actual start of testing. This is because the start of testing must be synchronized to the instruments internal 100ms clock.

If this command is sent during testing an error (-250) is generated.

Observation of status flags TIP, OST and EOT will provide information on test progress.

Stop Testing

This command causes the instrument to stop testing, irrespective of the type of testing it is performing. The results are now left unchanged and can be inspected at leisure. This command is equivalent to pressing the Start/Stop key on the front panel during testing.

STP

Notes:

There will be a delay of up to 200ms between the execution of this command and the actual end of testing. This is because the end of testing must be synchronized to the instruments internal 100ms clock.

If this command is sent while the instrument has stopped, an error (-251) is generated.

Timed start, date and time

This command sets up a date and time at which the instrument will start gating. The instrument will only start gating if the feature is enabled; this done by setting the 'start' field to "RUN". The value of seconds must be zero.

TMST

year, month, day, hour, minute, second, start *year = 1970 to 2069*
month = 1 or JAN
2 or FEB
3 or MAR
4 or APR
5 or MAY
6 or JUN
7 or JULY
8 or AUG
9 or SEP
10 or OCT
11 or NOV
12 or DEC
day = 1 to 31
hour = 0 to 23
minute = 0 to 59
second = 0
start = 0 or OFF
1 or SET
2 or RUN

The corresponding query command

TMST? returns *year, month, day, hour, minute, second, start*

Volume Control

This sets the beeper volume. It is equivalent to pressing either the increase or decrease volume keys on the front panel. Note that the volume setting is not remembered after a power cycle. In this case the volume will be set to a value equivalent to setting the midrange value.

There is no corresponding query command.

VOL <i>n</i>	<i>n</i> = 0 or OFF	Quietest
	1 or ON	Loudest
	2 or DECREASE	Decreases the level
	3 or INCREASE	Increases the level
	4 or MIDRANGE	Midrange level

Show History Status Query

This command is a request to determine which alarms have been set during the last test period or during the current test period if testing is in progress. This is functionally similar to pressing the history key on the front panel.

The history alarms (and leds) are all reset at the start of a test period. The result returned is the current value of the alarm history register as a binary weighted 16-bit integer. A full description of each alarm bit is given in Status Registers.

HIS? returns *n* = 0 to 16383

History Reset

This command resets the history alarm register (and leds) and is equivalent to pressing the history reset key on the front panel. It also resets the timeslot monitor NFAS display latch and timestamp results.

HSR

Single Error Add

This command injects a single error into the generator output stream provided that the generator has single error add enabled. If not, an error is produced. This command is equivalent to pressing the front panel single error add key.

SEA

9-54 Remote Control

Print Now

This command causes the instrument to produce a printout (on demand). The output will be returned to the controller as a common port is used for controlling and printing. This command is equivalent to pressing the front panel print now key.

REMLOG?

MISCELLANEOUS COMMANDS

The following commands perform a variety of unclassified operations on the instrument.

Display EFS or %EFS Result

This command selects whether the instrument displays EFS or %EFS results. Both results are simultaneously valid and may be accessed via remote control queries.

EFS n	$n = 1$ or EFS	Display EFS result
	2 or PCEFS	Display %EFS result

EFS? returns n where $n = 1$ or 2

Beep

This command causes an audio “beep” to be made by the instrument. It has no local equivalent operation.

BEEP

Display On/Off

This switches the instrument electroluminescent display ON or OFF. This is intended for battery option instruments only as a power conservation method. The command DIS OFF will have no effect on instruments not under battery power.

DIS n	$n = 0$ or OFF	Display disabled
	1 or ON	Display enabled

The complementary command returns the current display state in integer form as described above.

DIS? returns n where $n = 0$ or 1

Instrument Special Option Query

This command requests the special option string for the instrument. The OPT? command will not indicate the special features added to an instrument which this command does. The returned string is dependent on the nature of the special feature. The special feature is coded as a binary weighted integer.

SPECIAL?

Returns:-

<i>"string"</i>	<i>string</i> = NONE	Not a special instrument
	Bit 0	Hybrid. Special TERM/MON setting
	Bit 1	Counts errors during signal loss
	Bit 2	12V internal battery operation
	Bit 3	48V station battery operation
	Bit 4	User error inject ratios
	Bit 5	Bit errors not counted during sync loss
	Bit 8	Dutch PTT subrates
	Bit 9	Display in Italian
	Bit 10	Display in French
	Bit 11	Display in Spanish
	Bit 12	Display in Portuguese
	Bit 15	EDEL variant

FRAME HIERARCHY CONFIGURATION COMMANDS

The control fields relating to the following commands can be found on the timeslot and frame structure control fields as found on the OTHER pages of the instrument. These fields can be freely altered at any time but do not come into play unless the frame structure hierarchy selected on the SETTINGS page demands it.

Spare International Bits Set-Up

This sets the Si bits for 2 Mb/s non-CRC4 frame structures or the Si bits for the 704 kb/s (where fitted) frame structure.

SIB <i>rate</i> , " <i>bit</i> "	<i>rate</i> = 1 or F704K	704 kb/s
	2 or F2M	2 Mb/s
	" <i>bit</i> " = 0 or 1	Bit character

SIB? <i>rate</i>	<i>rate</i> = 1 or F704K
	2 or F2M
returns " <i>bit</i> "	" <i>bit</i> " = 0 or 1

E-Bits Set-Up

This sets the Si bits for 2 Mb/s CRC4 frame structures, otherwise known as E-bits in frames 13 & 15 of timeslots 0 and 16.

SEB "*bits*" = 2 characters 0 or 1

SEB? returns "*bits*" = 2 characters 0 or 1

Spare National Bits Set-Up

This sets the Si bits for 2 Mb/s and 704 kb/s. These bits appear in the NFAS frame timeslot-0 bits 4-8.

In the case of 2 Mb/s CRC4 framing, each bit-n ($4 \leq n \leq 8$) in each of the eight odd frames can be set as part of a codeword transmitted via these Sa bits. This results in one of the bits set via the SAB command being overwritten by a bit in the codeword set by the SAC command, the former bit number-n being set by the SAN command. The transmission of the codeword is enabled by the SAH command.

Sub Rate X.50 DIV 3 FAS Bits Set-Up

This sets the FAS bits for the sub rate structure X.50 div 3 (where fitted). This is also known as bit A.

XFB "*bit*" *bit* = 1 character 0 or 1

XFB? "*bit*" *bit* = 1 character 0 or 1

Sub Rate X.58 Service Octets Set-Up

This sets the service octets for the sub rate structure X.58 (where fitted). These octets are known as T1-T4, where T1 contains network bits A-H.

XFS <i>octet</i> , " <i>bits</i> "	<i>octet</i> = 1 or T1	Service octet T1
	2 or T2	Service octet T2
	3 or T3	Service octet T3
	4 or T4	Service octet T4

bits = 8 characters 0 or 1

XFS? <i>octet</i>	<i>octet</i> = 1 or T1	Service octet T1
	2 or T2	Service octet T2
	3 or T3	Service octet T3
	4 or T4	Service octet T4

Returns:-

"*bits*" *bits* = 8 characters 0 or 1

User Defined X.53 Mapping

This command is for the sub rate application only (where fitted). There is inter-reaction between this command and the XMAP and CCN commands. The X53 command allows user control of the data rate (bit/s) selected when the CCN command is issued. Each digit within the 4 digit X.53 has a different purpose.

1 This digit is fixed and is determined by the sub rate structure selected.

X.50 division-2	1
X.50 division-3	2
X.58	3

2 This is the digit defined with the X53 command, it determines the circuit rate. The instrument cold start values and the CCITT standard values are as follows. You can select between user defined and CCITT with the XMAP command.

	Instrument cold start	CCITT assigned
0		
1		
2		
3	600 bit/s	600 bit/s
4	2400 bit/s	2400 bit/s
5	4800 bit/s	4800 bit/s
6	9600 bit/s	9600 bit/s
7	14400 bit/s*	
8	19200 bit/s*	
9		

* Interleaved or Contiguous phases for 14400 bit/s and 19200 bit/s are selected with the CCN command.

Note: These values may neither be stored with SAV nor reset with RCL.

3 and 4 These digits determine the actual circuit selected.

n1 sets the rate for X.53 xlxx
etc

The instrument default is:

XMAP NONE,NONE,NONE,R600,R2400,R4800,R9600,R14400,R19200,NONE,1

The corresponding query command XMAP?

Returns:

n0,n1,n2,n3,n4,n5,n6,n7,n8,n9,m

n0 to *n9* = 0 .. 7

m = 1 .. 4

ALARM GENERATION, ERROR ADDITION AND FRAME SIMULATION COMMANDS

The following group of commands manipulate or overwrite the generated data stream with alarm information or error simulation functions. The corresponding control fields can be found on the SETTINGS page and under the relevant application.

Alarm Generation

Selects the type of alarm to be generated. The selection RMTMFM is not available for 2 Mb/s No MFM or CRC4 MFM frame types and the selection NOSIG is not available for binary interfaces. This command is available to generate alarms in applications 2 Mb/s, 704 kb/s and their corresponding frame simulate applications and also 2 Mb/s Tx, 64 kb/s Rx. Within these applications alarm generation is not available and is forced to OFF for through mode on, or when framing is off. The command is also available to generate a limited set of alarms in application 8Mb/s with framing on: OFF, AIS, REMOTE and NOSIG.

Alarm generation will also be forced to OFF for any unframed or drop and insert application and after a power cycle. This is to avoid the instrument suddenly generating AIS et al when least expected.

ALG <i>n</i>	<i>n</i> = 0 or OFF	Alarm generation off
	1 or AIS	AIS alarm
	2 or AIS_TRUE	AIS 2 zeros in 512 bits (true AIS)
	3 or AIS_FALSE	AIS 3 zeros in 512 bits (false AIS)
	4 or REMOTE	Bit 3 of NFAS timeslot set to 1
	5 or NOSIG	No signal
	6 or RMTMFM	Bit 6 of MFAS timeslot set to 1

ALG? returns *n* where *n* = 0 to 6

Error Add Type

Selects into which area of the transmit data error add is to be performed. Error add bit or code is not available for frame simulate or timeslot access applications nor for live data or through mode selections. Code error add is

not available for binary transmit interfaces. Frame error add refers to sub rate framing and is only available for the sub rate option (where fitted).

EAT <i>n</i>	<i>n</i> = 1 or BIT	Bit error add
	2 or CODE	Code error add
	3 or FRAME	Frame error add

EAT? returns *n* where *n* = 1 to 3

Error Add

Selects the method of error addition into the transmitter data stream.

EAD <i>n</i>	<i>n</i> = 1 or SINGLE	Enable single error add
	2 or RATE	Enable error rate add
	3 or OFF	No frame err add (8M)
	4 or R1IN4	1 in 4 FAS errored (8M)
	5 or R3IN4	3 in 4 FAS errored (8M)
	6 or ALL	All FAS errored (8M)

EAD? returns *n* where *n* = 1 to 6

Error Add Ratio

Selects the error add rate. This corresponds with EAD RATE. The parameter range is reduced to 2 .. 6 for sub rate (where fitted).

EAR <i>rate</i>	<i>rate</i> = 2 to 8	Rate 1E- <i>rate</i>
-----------------	----------------------	----------------------

EAR? returns *rate* where *rate* = 2 to 8

Sub Rate Burst Error Length

For sub rate application only (where fitted). For sub rate frame error addition, this selects the length of the frame error burst. The burst is initiated by the BUS command.

BEA <i>n</i>	<i>n</i> = 1 to 32	Length of burst
--------------	--------------------	-----------------

BEA? returns n where $n = 1$ to 32

Frame Simulate Test Type

Controls the frame simulate test type for the 2 Mb/s (or 704 kb/s where fitted) frame simulation application. Errors are added to the part of the frame structure selected herein. The selection is limited according to the frame type selected as shown.

Frame Type	FAS	NFAS	CAS MFAS	CRC MFAS	CRC BITS
(704 kb/s ON)	*	*	*		
CAS MFM	*	*	*		
NO MFM	*	*			
CAS,CRC4	*	*	*	*	*
CRC4 MFM	*	*		*	*

FTT n $n = 1$ or FAS FAS word
 2 or NFAS NFAS bits
 3 or CASMFAS CASMFAS word
 4 or CRCMFAS CRCMFAS word
 5 or CRC CRC bits

FTT? returns n where $n = 1$ to 5

Frame Simulate Test Error Mode

Selects the method of error insertion for frame errors as selected for frame simulate applications. Note that 2 Mb/s CRC MFAS word error add is only available in continuous mode.

FTM n $n = 1$ or BURST Burst error add
 2 or CONT Continuous error addition

FTM? returns n where $n = 1$ or 2

Frame Simulate Burst Error Length

If the frame test error mode (FTM) is selected as burst then this command will set the burst length. Note that the selection USER can only be achieved by setting the frame test type (FTT) to CRC bits where USER is the only selection available. Also, USER is not available for any other frame test type.

BEL <i>n</i>	<i>n</i> = 1 or ONE	Single error in burst
	2 or TWO	Two errors in burst
	3 or THREE	Three errors in burst
	4 or FOUR	Four errors in burst
	5 or FIVE	Five errors in burst
	6 or USER	User defined burst length

BEL? returns *n* where *n* = 1 to 6

Frame Simulate User Defined Burst Length

For burst error length (BEL) USER this selects the user defined burst length. This will only be available for CRC bits frame test in frame simulate applications.

BEU *n* *n* = 1 to 1000

BEU? returns *n* where *n* = 1 to 1000

Burst Error Start/Stop

For frame simulate or sub rate burst error add applications it is necessary to control when to add burst errors. Sending burst error start results in the burst error sequence being injected into the transmit data stream. The instrument will complete the burst and then revert to the stop condition. Alternatively, a burst stop command can be sent to prematurely stop the burst.

BUS <i>n</i>	<i>n</i> = 1 or STOP	Stop burst
	2 or START	Start burst

BUS? returns *n* where *n* = 1 or 2

Continuous Frame Error Add

Selects the continuous frame error add rate for frame simulate applications only and using continuous testing. The rates available are dependent on the frame test type selected (FTT). No selection is permitted outwith frame simulate applications.

Error Type	FAS	NFAS	CAS MFAS	CRC MFAS	CRC BITS
OFF	*	*	*	*	*
5E-6	*			*	
2E-5	*				
5E-4	*			*	
2E-3	*				
2 IN 4	*				*
1 IN 2	*	*	*		
3 IN 4	*	*			*
ALL		*	*		
LOSE SYNC					*
USER					*

FEA *n* *n* = 0 or OFF Off
 1 or R5E-6 Rate 5E-6
 2 or R2E-6 Rate 2E-5
 3 or R5E-4 Rate 5E-4
 4 or R2E-3 Rate 2E-3
 5 or R2IN4 Error 2 frame words in 4
 6 or R1IN2 Error 1 frame word in 2
 7 or R3IN4 Error 3 frame words in 4
 8 or ALL Error all frame words
 9 or LOSE Force loss of frame sync
 10 or USER Error N in 1000 frame bits

FEA? returns *n* where *n* = 0 to 10

User Defined Continuous Frame Error Add

This corresponds to the USER selection of the continuous frame error add command FEA. It selects the rate *n* in 1000 frame bits.

9-70 Remote Control

FEU n $n = 1$ to 1000



FEU? returns n where $n = 1$ to 1000



TEST PERIOD AND RESULTS CONFIGURATION COMMANDS

These commands relate to setting up the instrument test period, configuring the results display, timeslot monitor manipulation, analysis measurements and remote control response to alarm conditions. The majority of these fields can be found on the RESULTS page although the analysis threshold control is found on the OTHER page.

Test Period Type

Sets the type of test period for the instrument. Testing may then be started by using the STR command and stopped using the STP command, whatever the test period type. In SINGLE mode, the instrument will stop testing at the end of the test period. In MANUAL test mode, the instrument tests as before but only stops testing in response to the STP command. In TIMED mode, the single period starts when the "real time" clock time equals the timed start time; see the TMST command.

TTY <i>n</i>	<i>n</i> = 1 or MANUAL	Manual test interval
	2 or SINGLE	Single test interval
	3 or TIMED	Timed start

TTY? returns *n* where *n* = 1 or 3

Timed start, date and time

This command sets up a date and time at which the instrument will start gating. The value of seconds must be zero.

TMST *year,month,day,hour,minute,second,start*

year = 1970 to 2069
month = 1 or JAN
 2 or FEB
 3 or MAR
 4 or APR
 5 or MAY
 6 or JUN
 7 or JULY
 8 or AUG
 9 or SEP
 10 or OCT
 11 or NOV
 12 or DEC
day = 1 to 31
hour = 0 to 23
minute = 0 to 59
second = 0
start = 0 or OFF
 1 or SET
 2 or RUN

The corresponding query command

TMST? returns *year,month,day,hour,minute,second*

Test Period Duration

Selects the duration of the SINGLE test period as defined in the TTY command.

TPR <i>n</i>	<i>n</i> = 1 or MINS_15	15 minutes
	2 or MINS_30	30 minutes
	3 or HOURS_1	1 hour
	4 or HOURS_24	24 hours
	5 or USER	User program

TPR? returns *n* where *n* = 1 to 5

User Defined Test Period

Sets the user program single test period duration.

TDU	<i>period</i> = 1 to 100	Time multiplier
<i>period, units</i>	<i>units</i> = 1 or SECONDS	Seconds
	2 or MINUTES	Minutes
	3 or HOURS	Hours
	4 or DAYS	Days

TDU? returns *period* = 1 to 100
units = 1 to 4

Results Display Control

Selects whether BER MEASUREMENTS, TIMESLOT MONITOR, or SUB RATE MONITOR is performed. The instrument can only perform one form of measurement or another, i.e. no BER measurements can be performed while timeslot monitoring.

Timeslot monitoring is only available for framed signals in the applications 2 Mb/s, 704 kb/s and 64 kb/s TX, 2 Mb/s RX. Sub rate monitoring is only available for the sub rate option. BER measurements are always available.

RDS <i>n</i>	<i>n</i> = 1 or BER	BER measurements
	2 or T SLOT	Timeslot monitor
	3 or SUBRATE	Sub rate monitor

RDS? returns *n* where *n* = 1 to 3

Timeslot Result Display

Selects which timeslot bits are to be pulled from either the 2 Mb/s or the 704 kb/s structure for display. For 704 kb/s (where fitted), the second parameter-*n* can take any value. However, note that it alters the meaning of term 4.

The limitations for 2 Mb/s frame types are shown in the table:-

Timeslot Selection For Data and Signaling

Selects the data and signaling timeslot number for display in timeslot monitor. In 2 Mb/s applications, any CAS framing type will disallow selection of timeslot 16.

TSD <i>rate, n</i>	<i>rate</i> = 1 or F704K	704 kb/s
	2 or F2M	2 Mb/s
	<i>n</i> = 1 to 10	704 kb/s timeslot
	1 to 31	2 Mb/s timeslot

TSD? <i>rate</i>	<i>rate</i> = 1 or F704K
	2 or F2M
returns <i>n</i>	<i>n</i> = 1 to 10
	<i>n</i> = 1 to 31

Timeslot Signaling Selection - All or Single

Selects whether the instrument monitors a single or all of the signaling timeslots in timeslot monitor.

TSS <i>n</i>	<i>n</i> = 1 or SINGLE	Single timeslot display
	2 or ALL	All timeslots display

TSS? returns *n* where *n* = 1 or 2

Timeslot NFAS Display Event Capture Mode

For 2 Mb/s with CRC framing, the timeslot monitor NFAS display consists of all eight odd NFAS timeslot-0's. State change information for each bit is either permanently latched (LATCH) until the HSR command is received or monostabled. The monostable periods are 1-minute for the leftmost (Si) bits on the display and 1s for all others.

TNF <i>n</i>	<i>n</i> = 1 or MONOSTABLE	Monostable latch display
	2 or LATCH	Timestamp latch display

TNF? returns *n* where *n* = 1 or 2

Timeslot NFAS Display Latch Mask

For 2 Mb/s with CRC framing, the timeslot monitor NFAS display consists of all eight odd NFAS timeslot-0's. State change information for each bit is either permanently latched or monostabled. When in LATCH mode (TNF command) the state change is timestamped. The timestamp corresponds to the bit in the mask and any corresponding bit in any one of the odd frame timeslot-0's. On the instrument display, the mask is represented by asterisks, for convenience in remote control it is manipulated as a byte. The timestamp and latch record are cleared by the HSR command.

TNL "*bits*" *bits* = 8 characters 0 or 1

TNL? "*bits*" *bits* = 8 characters 0 or 1

Sub Rate Monitor Octet Number

This selects the data octet to be displayed within the channel chosen on the settings page for application sub rate. The octet number is the ordinal representation of the available octet position within a channel. The maximum number is dependent on the channel number chosen.

SRO *n* *n* = 1 to 70

SRO? returns *n* where *n* = 1 to 70

Sub Rate FAS Word Monitor For X.58

This selects which of the four X.58 FAS octets are to be displayed for application SUB RATE, while monitoring sub rate FAS bits.

SRF <i>n</i>	<i>n</i> = 1 or S1	FAS octet S1 (X.58)
	2 or S2	FAS octet S2 (X.58)
	3 or S3	FAS octet S3 (X.58)
	4 or S4	FAS octet S4 (X.58)

SRF? returns *n* where *n* = 1 to 4

Sub Rate Service Bits Monitor For X.58

This selects which of the four X.58 FAS octets are to be displayed for application SUB RATE, while monitoring sub rate service bits on X.58.

SRV <i>n</i>	<i>n</i> = 1 or T1	Service octet T1 (X.58)
	2 or T2	Service octet T2 (X.58)
	3 or T3	Service octet T3 (X.58)
	4 or T4	Service octet T4 (X.58)

SRV returns *n* where *n* = 1 to 4

Analysis Measurement Type

Selects whether the G.821 bit error analysis is based on the CCITT standard recommendation or on the annex-D recommendation which normalizes bit analysis measurements to 64 kb/s.

ANT <i>n</i>	<i>n</i> = 1 or STANDARD	G.821 standard
	2 or ANNEXD	G.821 annex-D

ANT? returns *n* where *n* = 1 or 2

Analysis Threshold Type

Selects whether the G.821 analysis results (standard or annex-D) are based on fixed or user programmable thresholds.

THT <i>n</i>	<i>n</i> = 1 or FIXED	G.821 fixed thresholds
	2 or USER	G.821 user program thresholds

THT? returns *n* where *n* = 1 or 2

SES Analysis Threshold

Selects the severely errored second threshold for the various analysis measurements. This area is found on the OTHER page for ANALYSIS CONTROL. The permitted range and meaning of the second parameter is dependent on the first. For bit and frame error thresholds, n is the radix of $1E-n$, while for crc and rebe errors n is the numerator in the threshold of $n/1000$.

THS <i>base,n</i>	<i>base</i> = 1 or BIT	Bit error SES threshold
	2 or FRAME	Frame error SES threshold
	3 or CRC	CRC error SES threshold
	4 or REBE	REBE error SES threshold
	<i>n</i> = 2 to 5	Bit and frame $1E-n$
	1 or 1000	CRC and REBE n in 1000

THS? <i>base</i>	<i>base</i> = 1 or BIT	
	2 or FRAME	
	3 or CRC	
	4 or REBE	
returns <i>n</i>	<i>n</i> = 2 to 5	
	<i>n</i> = 1 to 1000	

Degraded Minutes Analysis Threshold

Selects the degraded minutes threshold for the various analysis measurements. This area is found on the OTHER page for ANALYSIS CONTROL. The permitted range and meaning of the second parameter is dependent on the first. For bit and frame error thresholds, n is the radix of $1E-n$, while for crc and rebe errors n is the numerator in the threshold of $n/1000$.

THD <i>base,n</i>	<i>base</i> = 1 or BIT	Bit error Degraded Minutes threshold
	2 or FRAME	Frame error Degraded Minutes threshold
	3 or CRC	CRC error Degraded Minutes threshold
	4 or REBE	REBE error Degraded Minutes threshold
	<i>n</i> = 2 to 7	Bit and frame $1E-n$
	1 to 1000	CRC and REBE n in 1000

THD? *base* *base* = 1 or BIT
 2 or FRAME
 3 or CRC
 4 or REBE
 returns *n* *n* = 2 to 7
 n = 1 to 1000

Alarm Mask Register

Sets up Alarm Mask Register (AMR). This register is used to determine under what conditions the Alarm Change (ALC) bit in Status Register A should be set. If a bit in the Alarm Status Register changes (either from 1 to 0 or vice-versa), and the corresponding bit in the Alarm Mask Register is set, the ALC bit in Status Registers A and B are set. The ALC bit is cleared by the ALM?, RST, CLR, (\$DCL or \$SDC in HP-IB) commands.

The argument to AMR can be specified in a number of ways.

As a binary-weighted integer (see Alarm Register in the Status Registers section)

As a list of integer values (which are OR'd together)

As a list of alarm mnemonics (see Alarm Register in the Status Registers section)

AMR *n* *n* = 0 to 16383
 To disable all alarms,
 specify AMR 0 or AMR NONE

AMR? returns *n* where *n* = 0 to 16383

RESULT QUERY COMMANDS

This section contains all measurement result query commands. If these commands are executed outside testing, the last test period results are returned; during testing the results returned are the "current" results.

Some results are not always available, therefore they return not only the result but a validity flag. For example, analysis measurement results are defined for one second boundaries while error count results are resolved to 100ms boundaries such that at the start of a test error count results will become valid before analysis results. In addition a second flag *oor* (out of range) will indicate whether the result is underrange (0), inrange (1) or overrange (2). For most results this will always be inrange unless otherwise stated. It is included in all results however, to maintain a consistent format.

NOTE: The commands in this section have the effect of clearing the EOT bit in Status Registers A and B.

Bit Error Result Query

This command requests one of the bit error results. The format of the result returned will depend upon the selected result. Bit error results are only available for settings involving the setting up of a none-live pattern field.

RSB? <i>n</i>	<i>n</i> = 1 or EC	Error count
	2 or EFS	Error free seconds
	3 or ER	Average error ratio
	4 or CUER	Current error ratio
	5 or PCEFS	% Error free seconds

Returns:-

<i>flag, oor, n</i>	<i>flag</i> = 0 or 1	Validity Flag
	<i>oor</i> = 1	Inrange
	<i>n</i> = 0 to 999999	EC, PCEFS, EFS < 1000000
	<i>n</i> = 1.000E+6 to 9.999E+99	EC, PCEFS, EFS ≥ 1000000
	<i>n</i> = 0 to 1.000E+00	ER, PCEFS, CUER
	0.00000 to 100.00000	

Code Error Result Query

This command requests one of the code error results. The format of the result returned will depend upon the selected result. Code error results are only valid for ternary receiver interfaces.

RSC? <i>n</i>	<i>n</i> = 1 or EC	Error count
	2 or EFS	Error free seconds
	3 or ER	Average error ratio
	4 or CUER	Current error ratio
	5 or PCEFS	% Error free seconds

Returns:-

<i>flag,oor,n</i>	<i>flag</i> = 0 or 1	Validity Flag
	<i>oor</i> = 1	Inrange
	<i>n</i> = 0 to 999999	EC, PCEFS, EFS < 1000000
	<i>n</i> = 1.000E+6 to 9.999E+99	EC, PCEFS, EFS ≥ 1000000
	<i>n</i> = 0 to 1.000E+00	ER, PCEFS, CUER
	0.00000 to 100.00000	

Frame Error Result Query

This command requests one of the frame error results. The format of the result returned will depend upon the selected result. Frame error results are only valid for 2 Mb/s, 704 kb/s and 8Mb/s receiver rates with framing on. For the sub rate application (where fitted), the result relates to sub rate framing.

RFE? <i>n</i>	<i>n</i> = 1 or EC	Error count
	2 or EFS	Error free seconds
	3 or ER	Average error ratio
	4 or CUER	Current error ratio
	5 or PCEFS	% Error free seconds

Returns:-

<i>flag,oor,n</i>	<i>flag</i> = 0 or 1	Validity Flag
	<i>oor</i> = 1	Inrange
	<i>n</i> = 0 to 999999	EC, PCEFS, EFS < 1000000
	<i>n</i> = 1.000E+6 to 9.999E+99	EC, PCEFS, EFS ≥ 1000000
	<i>n</i> = 0 to 1.000E+00	ER, PCEFS, CUER
	0.00000 to 100.00000	

CRC Error Result Query

This command requests one of the CRC error results. The format of the result returned will depend upon the selected result. CRC error results are only valid for 2 Mb/s receiver modes with CRC4 framing.

RCR? <i>n</i>	<i>n</i> = 1 or EC	Error count
	2 or EFS	Error free seconds
	3 or ER	Average error ratio
	4 or CUER	Current error ratio
	5 or PCEFS	% Error free seconds

Returns:-

<i>flag,oor,n</i>	<i>flag</i> = 0 or 1	Validity Flag
	<i>oor</i> = 1	Inrange
	<i>n</i> = 0 to 999999	EC, PCEFS, EFS < 1000000
	<i>n</i> = 1.000E+6 to 9.999E+99	EC, PCEFS, EFS ≥ 1000000
	<i>n</i> = 0 to 1.000E+00	ER, PCEFS, CUER
	0.00000 to 100.00000	

REBE Error Result Query

This command requests one of the REBE error results. The format of the result returned will depend upon the selected result. REBE error results are only valid for 2 Mb/s receiver modes with CRC4 framing.

RRE? <i>n</i>	<i>n</i> = 1 or EC	Error count
	2 or EFS	Error free seconds
	3 or ER	Average error ratio
	4 or CUER	Current error ratio
	5 or PCEFS	% Error free seconds

Returns:-

<i>flag,oor,n</i>	<i>flag</i> = 0 or 1	Validity Flag
	<i>oor</i> = 1	Inrange
	<i>n</i> = 0 to 999999	EC, PCEFS, EFS < 1000000
	<i>n</i> = 1.000E+6 to 9.999E+99	EC, PCEFS, EFS ≥ 1000000
	<i>n</i> = 0 to 1.000E+00	ER, PCEFS, CUER
	0.00000 to 100.00000	

Analysis Measurement Parameters Query

This command requests the conditions under which all of the analysis results were made, whether the measurements were performed with fixed or programmed thresholds and whether the bit measurement was standard or annex-D.

RAT?

Returns:-

<i>flag,oor,n</i>	<i>flag</i> = 0 or 1	Validity Flag
	<i>oor</i> = 1	Inrange
	<i>n</i> = 1	Standard measurement using fixed thresholds
	<i>n</i> = 2	Standard measurement using user thresholds
	<i>n</i> = 3	Annex-D measurement using fixed thresholds
	<i>n</i> = 4	Annex-D measurement using user thresholds

Bit Analysis Result Query

This command requests one of the bit analysis results. The format of the result returned will depend upon the selected result. Bit error results are only available for settings involving the setting up of a none-live pattern field.

RBA? <i>n</i>	<i>n</i> = 1 or UAS	Unavailable seconds
	2 or PCUAV	% Unavailable seconds
	3 or ES	G.821 error seconds
	4 or PCES	G.821 % error seconds
	5 or SES	G.821 severely error seconds
	6 or PCSES	G.821 % severely error seconds
	7 or DM	Degraded minutes
	8 or PCDM	% Degraded minutes
	9 or LTMER	Long Term Mean Error Ratio

Returns:-

<i>flag,oor,n</i>	<i>flag</i> = 0 or 1	Validity Flag
	<i>oor</i> = 1	Inrange
	<i>n</i> = 0 to 999999999	Seconds, minutes results
	<i>n</i> = 0.00000 to 100.00000	Percentage result
	<i>n</i> = 0.0 to 1.000E+00	LTMER result

Frame Analysis Result Query

This command requests one of the frame analysis results. The format of the result returned will depend upon the selected result. Frame error results are only valid for 2 Mb/s, 704 kb/s and 8Mb/s receiver rates with framing on.

RFA? <i>n</i>	<i>n</i> = 1 or UAS	Unavailable seconds
	2 or PCUAV	% Unavailable seconds
	3 or ES	G.821 error seconds
	4 or PCES	G.821 % error seconds
	5 or SES	G.821 severely error seconds
	6 or PCSES	G.821 % severely error seconds
	7 or DM	Degraded minutes
	8 or PCDM	% Degraded minutes
	9 or LTMER	Long Term Mean Error Ratio

Returns:-

<i>flag, oor, n</i>	<i>flag</i> = 0 or 1	Validity Flag
	<i>oor</i> = 1	Inrange
	<i>n</i> = 0 to 999999999	Seconds, minutes results
	<i>n</i> = 0.00000 to 100.00000	Percentage result
	<i>n</i> = 0.0 to 1.000E+00	LTMER result

CRC Analysis Result Query

This command requests one of the CRC analysis results. The format of the result returned will depend upon the selected result. CRC error results are only valid for 2 Mb/s receiver modes with CRC4 framing.

RCA? <i>n</i>	<i>n</i> = 1 or UAS	Unavailable seconds
	2 or PCUAV	% Unavailable seconds
	3 or ES	G.821 error seconds
	4 or PCES	G.821 % error seconds
	5 or SES	G.821 severely error seconds
	6 or PCSES	G.821 % severely error seconds
	7 or DM	Degraded minutes
	8 or PCDM	% Degraded minutes
	9 or LTMER	Long Term Mean Error Ratio

Returns:-

<i>flag,oor,n</i>	<i>flag</i> = 0 or 1	Validity Flag
	<i>oor</i> = 1	Inrange
	<i>n</i> = 0 to 999999999	Seconds, minutes results
	<i>n</i> = 0.00000 to 100.00000	Percentage result
	<i>n</i> = 0.0 to 1.000E+00	LTMER result

REBE Analysis Result Query

This command requests one of the REBE analysis results. The format of the result returned will depend upon the selected result. REBE error results are only valid for 2 Mb/s receiver modes with CRC4 framing.

RRA? <i>n</i>	<i>n</i> = 1 or UAS	Unavailable seconds
	2 or PCUAV	% Unavailable seconds
	3 or ES	G.821 error seconds
	4 or PCES	G.821 % error seconds
	5 or SES	G.821 severely error seconds
	6 or PCSES	G.821 % severely error seconds
	7 or DM	Degraded minutes
	8 or PCDM	% Degraded minutes
	9 or LTMER	Long Term Mean Error Ratio

Returns:-

<i>flag,oor,n</i>	<i>flag</i> = 0 or 1	Validity Flag
	<i>oor</i> = 1	Inrange
	<i>n</i> = 0 to 999999999	Seconds, minutes results
	<i>n</i> = 0.00000 to 100.00000	Percentage result
	<i>n</i> = 0.0 to 1.000E+00	LTMER result

Alarm Seconds Result Query

This command returns the total number of seconds for which a particular alarm has been present in the current or previous test period. If the requested alarm duration is not available for the current settings of the instrument, a validity of 0 will be returned.

ALR? <i>n</i>	<i>n</i> = 1 or POWER	Power loss
	2 or SIGNAL	Signal loss
	3 or AIS	AIS
	4 or FRAME	Frame loss
	5 or CRCMFM	CRC Mframe loss
	6 or CASMFM	CAS Mframe loss
	7 or PATTERN	Pattern sync loss
	8 or OCTET	Octet loss (codirectional)
	9 or REMOTE	Remote alarm
	10 or RMTMFM	Remote Mframe alarm
	11 or SUBFRAME	Sub rate frame loss
	12 or SUBREMOTE	Sub rate remote alarm

Returns:-

<i>flag,oor,n</i>	<i>flag</i> = 0 or 1	Validity Flag
	<i>oor</i> = 1	Inrange
	<i>n</i> = 0 to 999999999	Seconds results

Frequency Result Query

This command requests one of the frequency measurement results. The absolute frequency result is valid for all applications except TONES and SUB RATE, while frequency offset is valid for the same applications except those using a 64 kb/s receiver. These results are always available and do not require the instrument test period to be started.

Note that the frequency result remains valid even if no signal is present. Under these circumstances the count will be zero. In the case of frequency offset the range flag will indicate underrange (U/R) if no signal is present.

RSF? <i>n</i>	<i>n</i> = 1 or FREQ	Absolute frequency
	2 or OFFSET	Offset in ppm

Returns:-

<i>flag,oor,n</i>	<i>flag</i> = 0 or 1	Validity Flag
	<i>oor</i> = 0 to 2	0: Underrange, 1: Inrange, 2: Overrange
	<i>n</i> = 0 to 999999999	Frequency in Hz
	<i>n</i> = -199 to +199	Offset in ppm

Round Trip Delay Query

This command requests the round trip delay result as found on the SIGNAL subpage of the results. Round trip delay measurements are continuous and are not controlled from the START/STOP key. Round trip delay is valid for 2 Mb/s ternary signals with a HDB3 linecode carrying a $2^{23}-1$ pattern. The result will be invalid for all other configurations.

The result is also forced invalid by: Signal Loss, AIS, Frame Loss or Pattern Loss. When all of these alarms are cleared, the result will go under range ("wait" message) while the measurement is re-calculating. Delays longer than 1023 ms cause the result to go over range (O/R).

Results are presented in low or high resolution format (see below). An autorange feature selects high resolution for results of less than 50 ms or low resolution for results over 50 ms. The threshold has ± 1 ms hysteresis.

RRT?

Returns:-

<i>flag, oor, n</i>	<i>flag</i> = 0 or 1 <i>oor</i> = 0 to 2 <i>n</i> = 0 to 9999999 0 to 999.999	Validity Flag 0: Underrange, 1: Inrange, 2: Overrange milliseconds (low resolution) milliseconds (high resolution)
---------------------	--	---

COFA Result Query

This command requests the COFA result as found on the SIGNAL subpage of the results. This measurement is controlled from the START/STOP key and is valid for any 2 Mb/s receiver application with framing except for the TONES application.

RCS?

Returns:-

<i>flag, oor, n</i>	<i>flag</i> = 0 or 1 <i>oor</i> = 0 to 2 <i>n</i> = 0 to 999999999	Validity Flag 0: Underrange, 1: Inrange, 2: Overrange Count
---------------------	--	---

Pattern Slips Result Query

This command requests the pattern slips result as found on the SIGNAL subpage of the results. This measurement is controlled from the START/STOP key and is valid for any 2 Mb/s, 704kb/s or 64kb/s receiver application with a prbs pattern .

RPS?

Returns:-

<i>flag,oor,n</i>	<i>flag</i> = 0 or 1	Validity Flag
	<i>oor</i> = 1	Inrange
	<i>n</i> = 0 to 999999999	Count

Tone Frequency Result Query

This command requests the tone frequency found in the receive timeslot under application TONES. This measurement is always available in that it does not require use of the START/STOP key, just a properly framed 2 Mb/s signal.

'TSF?' returns <i>flag,oor,n</i>	<i>flag</i> = 0 or 1	Validity Flag
	<i>oor</i> = 1	Inrange
	<i>n</i> = 0 to 9999999	Frequency in Hz

Tone Level Result Query

This command requests the tone level found in the receive timeslot under application TONES. This measurement is always available in that it does not require use of the START/STOP key, just a properly framed 2 Mb/s signal.

'TSL?' returns <i>flag,oor,n</i>	<i>flag</i> = 0 or 1	Validity Flag
	<i>oor</i> = 1	Inrange
	<i>n</i> = 0.0 to -80.0	Tone level in dBm0

Elapsed Time Result Query

This command requests the elapsed time since the start of the current test. the validity flag will always appear to be set in this result as it is almost immediately cleared and set again at the start of subsequent test runs.

ELP?

Returns:-

<i>flag,dd,hh,mm,ss</i>	<i>flag</i> = 0 or 1	Validity Flag
	<i>dd</i> = 0 to 99	Days
	<i>hh</i> = 0 to 23	Hours
	<i>mm</i> = 0 to 59	Minutes
	<i>ss</i> = 0 to 59	Seconds

Timeslot Monitor Query

This command returns the bit result (in quotes) for the currently selected timeslot monitor or sub rate display. The returned result will be a binary number string, enclosed in quotes, of either 4-bits (signaling) or 8-bits (other) wide.

BIT?

Returns:-

<i>flag,oor,"n"</i>	<i>flag</i> = 0 or 1	Validity Flag
	<i>oor</i> = 1	Inrange
	<i>n</i> = 8 bits 0 or 1	monitor result, except signaling
	<i>n</i> = 4 bits 0 or 1	monitor result for T/S signaling

Timeslot Monitor All Signaling Bits Query

This command returns the signaling bits result (in quotes) which applies when timeslot monitoring ALL signaling bits. N.B. Use BIT? for timeslot monitoring of the signaling bits relating to a SINGLE timeslot. The returned result will be a 4-bit binary number string enclosed in quotes.

SIG? <i>tslot</i>	<i>tslot</i> = 1 to 15,17 to 31	For 2 Mb/s signaling
	<i>tslot</i> = 1 to 10	For 704 kb/s signaling

Returns:-

<i>flag,oor,"n"</i>	<i>flag</i> = 0 or 1	Validity Flag
	<i>oor</i> = 1	Inrange
	" <i>n</i> " = 4 bits 0 or 1	T/S monitor result

Timeslot Monitor All NFAS Bits Query

This command returns the NFAS bits result (in quotes) which applies when timeslot monitoring 2 Mb/s CRC NFAS bits. There are eight separate results, one for each odd frame of the multiframe. N.B. Use BIT? for timeslot monitoring of the NFAS bits relating to a 2 Mb/s non-CRC NFAS timeslot. The returned result will be an 8-bit binary number string enclosed in quotes.

NFS? *frame* *frame* = 1,3,5,7,9,11,13,15 Odd frame number

Returns:-

<i>flag,oor,"n"</i>	<i>flag</i> = 0 or 1	Validity Flag
	<i>oor</i> = 1	Inrange
	<i>"n"</i> = 8 bits 0 or 1	T/S monitor result

Timeslot Monitor NFAS Latch Query

This command returns the NFAS latch result (in quotes) which applies when timeslot monitoring 2 Mb/s CRC NFAS bits. There are eight separate results, one for each odd frame of the multiframe. The returned result will be an 8-bit binary number string enclosed in quotes representing the display of “-” and “X” on the display. A state change is represented by “X” on the display or “1” in the query result.

NFL? *frame* *frame* = 1,3,5,7,9,11,13,15 Odd frame number

Returns:-

<i>flag,oor,"n"</i>	<i>flag</i> = 0 or 1	Validity Flag
	<i>oor</i> = 1	Inrange
	<i>"n"</i> = 8 bits 0 or 1	T/S monitor latch result

Timeslot Monitor NFAS Latch Timestamp Query

This command returns the NFAS latch timestamp result which applies when timeslot monitoring 2 Mb/s CRC NFAS bits in LATCH mode. There are eight separate results, one for each odd frame of the multiframe. The returned result will be a time and date representing the first occurrence of a state change in

that timeslot. (The state change must also be coincident with the relevant bit in the state change mask).

NFT? frame *frame = 1,3,5,7,9,11,13,15* Odd frame number

Returns:-

flag, oor, hours, mins, secs, years, months, days

<i>flag</i>	0 or 1	Validity Flag
<i>oor</i>	1	Inrange
<i>hours</i>	0 to 23	T/S monitor timestamp
<i>mins</i>	0 to 59	T/S monitor timestamp
<i>secs</i>	0 to 59	T/S monitor timestamp
<i>years</i>	1970 to 2069	T/S monitor timestamp
<i>months</i>	1 to 12	T/S monitor timestamp
<i>days</i>	1 to 31	T/S monitor timestamp

Alarm Change Status Query

This returns the current value of the alarm change status register as a binary weighted 16-bit integer, each bit of which corresponds to its counterpart in the alarm register. The change register records 0 -> 1 or 1 -> 0 transitions of any alarm register status bit at any time during or outside testing. This permits the source of an alarm change (ALC) to be traced if the alarm resets itself. The register is cleared each time it is read.

ALC? returns *n* where *n* = 0 to 16383

Alarm Status Query

This returns the current value of the alarm change status register as a binary weighted 16-bit integer. A full description of each alarm bit is given in the Status Register section. This command also clears the ALC bits in Status Registers A and B.

ALM? returns *n* where *n* = 0 to 16383

9-92 Remote Control

M.2110 pass/fail query

This command allows access to the M.2110 1-day and 7-day pass/fail result.

The syntax is:

```
M2110? n                n = 1 or DAY
                          2 or WEEK
returns "flag,oor,string"
                flag = Validity flag, always 1
                oor = Out of range, always Inrange
                string = PASS
                          FAIL
                          WAIT
```

M.2120 report count query

This command allows access to the M.2120 TR1 (15-minute) and TR2 (24-hour) reports.

The syntax is:

```
M2120? duration,path
M2120? duration,path    duration =
                          1 or TR1      15 minute duration
                          path = 2 or TR2  24 hour duration
                          1 or RX
                          2 or TX
```

Returns:-

```
flag,oor,n              flag = 0 or 1          Validity Flag
                          oor = 1             Inrange
                          n = 0 to 999999999  Result
```

Slip (estimated) Result Query

This command requests the (estimated) bit slips as detailed on the signal page. This measurement is controlled from the START/STOP key and is valid for any 2Mb/s receiver measurement in option-010 (only) instruments.

9-94 Remote Control

STORED MEASUREMENT AND GRAPHICS COMMANDS

The commands in this section control the stored measurement and graphics function of the instrument and access the information stored. In the case of commands with four letter mnemonics, these are only available outwith a test period and access stored measurement information from previously run tests. For stored measurement result query commands, these are similar to those listed in the RESULT QUERY COMMAND section with the addition of a first parameter pointing to the store in question. (This parameter should have value 0 to access the LAST measurement store.)

These commands do not affect any status registers unlike their RESULT QUERY command counterparts.

Store Measurement Results Enable

This enables or disables graphs and results storage. The enable choices also include how often results are stored during a test, i.e. the resolution of the resultant graphics.

SRGn	n = 0 or OFF	Storage off
	1 or MIN_1	Store every 1 minute
	2 or MIN_15	Store every 15 minutes
	3 or HOUR_1	Store every 1 hour

SRG? returns *n* where *n* = 0 to 3

Store Size and Usage

This accesses the fixed size and the current usage of the stored measurement store. The returned results are in samples and the ratio of the two will give the relative store size used. (A sample may be either 1, 15 or 60 minutes duration).

SMS?

Returns:-

<i>size, usage</i>	<i>size</i> = 2048	Max size in samples
	<i>usage</i> = 0..... <i>size</i>	Usage in samples

Detailed Store Use Query

This command returns store use information as lines. Each line will contain statistical information related to each used store entry. Unused stores will produce no lines. This information corresponds to that found on the STORE STATUS page.

SMC?

Returns:-

store-0,demo,yr,mnth,day,hr,min,samples, resolu
store-1,demo,yr,mnth,day,hr,min,samples, resolu
store-2,demo,yr,mnth,day,hr,min,samples, resolu

EOI

<i>store</i> = -9 to 0	Store number
<i>demo</i> = 0 to 1	Demo (1) or Test (0) period
<i>yr</i> = 1970 to 2069	Start year
<i>mnth</i> = 1 to 12	Start month
<i>day</i> = 1 to 31	Start day
<i>hr</i> = 0 to 23	Start hours
<i>min</i> = 0 to 60	Start minutes
<i>samples</i> = 1 to 6000	No. of samples in test period
<i>resolu</i> = 1, 15, 60	Resolution in minutes

An example of returned data is:

```
0, 0, 1990, 1, 24, 10, 14, 2345, 1
-1, 0, 1990, 1, 10, 23, 54, 980, 1
-2, 1, 1989, 12, 24, 7, 45, 458, 1
-3, 0, 1989, 12, 5, 7, 23, 561, 15
-4, 0, 1989, 11, 7, 8, 12, 2197, 60
```

EOI

Delete All SMG Stores

This command deletes all stored measurement and graphics (SMG) stores.

SMDA

Delete One SMG Store

This command deletes the selected stored measurement and graphics (SMG) store.

SMDS *n*

n = -9 to 0 Store number

Stored Graphical Data Query

This command returns store sample data as a series of records, one for each sample, for store *n*. This could return as much as 6000 lines of information.

SMD? *n* *n* = -9 to 0 Store number

Returns:-

g1-data,g2-data,g3-data,g4-data,g5-data, "alarm-bits 1", "alarm-bits 2",
"alarm-bits 3"

g1-data,g2-data,g3-data,g4-data,g5-data, "alarm-bits 1", "alarm-bits 2",
"alarm-bits 3"

g1-data,g2-data,g3-data,g4-data,g5-data, "alarm-bits 1", "alarm-bits 2",
"alarm-bits 3"

|
|
EOI

<i>g1-data</i> = XE+Y	Bit error count in 1 sample
<i>g2-data</i> = XE+Y	Code error count in 1 sample
<i>g3-data</i> = XE+Y	Frame error count in 1 sample
<i>g4-data</i> = XE+Y	CRC error count in 1 sample
<i>g5-data</i> = XE+Y	REBE error count in 1 sample
"alarm-bits 1" = 8 characters 1 or 0	Alarms for that sample
"alarm-bits 2" = 8 characters 1 or 0	Alarms for that sample
"alarm-bits 3" = 8 characters 1 or 0	Alarms for that sample

Note: In the alarm bit strings, 1 indicates that the alarm was present. From left to right the alarms are:

Alarm bits 1: Power Loss, Signal Loss, AIS, Frame Loss, CRC Mframe Loss, CAS Mframe Loss, Pattern Loss and Octet Loss.

N.B. Frame loss is the OR of bearer frame loss and sub rate frame loss for the sub rate application (where fitted).

Alarm bits 2: COFA, Pattern Slip, M.2100 In Service RX-ES, RX-SES, RX-UAS, TX-ES, TX-SES, TX-UAS.

Alarm bits 3: M.2100 Out Of Service RX-ES, RX-SES, RX-UAS, (unused),
M.2120 In Service RX-TR1 Report, Tx-TR2 Report.

An example of returned data for an 8-sample period is:

```
0E+0, 0E+0, 0E+0, 0E+0, 0E+0, "00000000", "00000000", "00000000"  
1E+0, 0E+0, 0E+0, 0E+0, 0E+0, "00000000", "00000000", "00000000"  
4E+1, 5E+2, 0E+0, 0E+0, 0E+0, "00010000", "00010000", "00010000"  
0E+0, 0E+0, 0E+0, 0E+0, 0E+0, "00000000", "00000000", "00000000"  
0E+0, 0E+0, 0E+0, 0E+0, 0E+0, "00000000", "00000000", "00000000"  
8E+8, 5E+5, 0E+0, 0E+0, 0E+0, "01100000", "01100000", "01100000"  
0E+0, 0E+0, 0E+0, 0E+0, 0E+0, "00000000", "00000000", "00000000"  
0E+0, 0E+0, 0E+0, 0E+0, 0E+0, "00000000", "00000000", "00000000"  
EOI
```

Stored Graphical Data in Compressed Form Query

This command returns store sample data for the specified store in a more compressed form than that of the SMD? command. Each output line is prepended by an integer repeat counter. Since for live data a lot of the samples will be zero, the data size will be very much compressed. It is up to the controller to interpret the data back to its uncompressed form.

SMZ? *n* *n* = -9 to 0 Store number

Returns:-

n1,g1-data,g2-data,g3-data,g4-data,g5-data, "alarm-bits 1", "alarm-bits 2", "alarm-bits 3"

n2,g1-data,g2-data,g3-data,g4-data,g5-data, "alarm-bits 1", "alarm-bits 2", "alarm-bits 3"

n3,g1-data,g2-data,g3-data,g4-data,g5-data, "alarm-bits 1", "alarm-bits 2", "alarm-bits 3"

EOI

<i>n1,n2</i> = 1 to 6000	Number of repeated results
<i>g1-data</i> = XE+Y	Bit error count in 1 sample
<i>g2-data</i> = XE+Y	Code error count in 1 sample
<i>g3-data</i> = XE+Y	Frame error count in 1 sample
<i>g4-data</i> = XE+Y	CRC error count in 1 sample
<i>g5-data</i> = XE+Y	REBE error count in 1 sample
<i>"alarm-bits 1"</i> = 8 characters 1 or 0	Alarms for that sample
<i>"alarm-bits 2"</i> = 8 characters 1 or 0	Alarms for that sample
<i>"alarm-bits 3"</i> = 8 characters 1 or 0	Alarms for that sample

Note: In the alarm bit strings, 1 indicates that the alarm was present. From left to right the alarms are:

Alarm bits 1: Power Loss, Signal Loss, AIS, Frame Loss, CRC Mframe Loss, CAS Mframe Loss, Pattern Loss and Octet Loss

N.B. Frame loss is the OR of bearer frame loss and sub rate frame loss for the sub rate application (where fitted).

Alarm bits 2: COFA, Pattern Slip, M.2100 In Service RX-ES, RX-SES, RX-UAS, TX-ES, TX-SES, TX-UAS.

Alarm bits 3: M.2100 Out Of Service RX-ES, RX-SES, RX-UAS, (unused), M.2120 In Service RX-TR1 Report, Tx-TR2 Report.

An example of returned data is (cf SMD? example):

```
1, 0E+0, 0E+0, 0E+0, 0E+0, 0E+0, "00000000", "00000000", "00000000"  
1, 1E+0, 0E+0, 0E+0, 0E+0, 0E+0, "00000000", "00000000", "00000000"  
1, 4E+1, 5E+2, 0E+0, 0E+0, 0E+0, "00010000", "00010000", "00010000"  
2, 0E+0, 0E+0, 0E+0, 0E+0, 0E+0, "00000000", "00000000", "00000000"  
1, 8E+8, 5E+5, 0E+0, 0E+0, 0E+0, "01100000", "01100000", "01100000"  
2, 0E+0, 0E+0, 0E+0, 0E+0, 0E+0, "00000000", "00000000", "00000000"  
EOI
```

Stored Application Mode Query

Queries the application for the instrument for the particular store requested. The response corresponds with the APP command.

SAPP? *n* *n* = -9 to 0 Store number

Returns:- *m* where *m* = 1 to 12

Stored Interface Type Query

Queries the Tx and Rx hardware interface for the instrument for the particular store requested. The response corresponds with the IFC command.

SIFC? *n* *n* = -9 to 0 Store number

Returns:- *m* where *m* = 1 to 4

Stored Ternary Linecode Query

Queries the ternary linecode for the instrument for the particular store requested. The response corresponds with the COD command.

SCOD? *n* *n* = -9 to 0 Store number

Returns:- *m* where *m* = 1 to 2

Stored Bearer Rate Query

Queries the sub rate bearer rate for the instrument for the particular store requested. The response corresponds with the BRR command.

SBRR? *n* *n* = -9 to 0 Store number

Returns:- *m* where *m* = 1 or 2

Stored Framing Type Query

Queries the framing type (2 Mb/s or 704 kb/s) for the instrument for the particular store requested. The response corresponds with the FRM command.

SFRM? n $n = -9$ to 0 Store number

Returns:- m where $m = 0$ to 4

Stored Pattern Type Query

Queries the pattern type for the instrument for the particular store requested. The response corresponds with the PAT command.

SPAT? n $n = -9$ to 0 Store number

Returns:- m where $m = 1$ to 10

Stored PRBS Polarity Query

Queries PRBS polarity for the instrument for the particular store requested. The response corresponds with the PPO command.

SPP0? n $n = -9$ to 0 Store number

Returns:- m where $m = 1$ or 2

Stored User Defined Word Pattern Query

Queries the user defined word pattern type for the instrument for the particular store requested. The response corresponds with the PAU command.

SPAU? n $n = -9$ to 0 Store number

Returns:- "*patt*" where "*patt*" = 16 characters 0 or 1 or F

Stored Long User Word Number Query

Queries the long user word number in use for the instrument for the particular store requested. The response corresponds with the LUS command.

SLUS? n $n = -9$ to 0 Store number

Returns:- m where $m = 1$ to 4

9-104 Remote Control

Stored Sub Rate Circuit Number Query

Queries the sub rate circuit number for the instrument for the particular store requested. The response corresponds with the CCN command.

SCCN? *n* *n* = -9 to 0 Store number

Returns:- *m* where *m* = 1301 to 3804

Stored Tone Frequency Query

Queries the fixed tone frequency for the instrument for the particular store requested. The response corresponds with the TFF command.

STFF? *n* *n* = -9 to 0 Store number

Returns:- *m* where *m* = 1 to 5

Stored User Defined Tone Frequency Query

Queries the user program tone frequency for the instrument for the particular store requested. The response corresponds with the TFU command.

STFU? *n* *n* = -9 to 0 Store number

Returns:- *m* where *m* = 100 to 4000

Stored Tone Level Query

Queries the user program tone level for the instrument for the particular store requested. The response corresponds with the TFL command.

STFL? *n* *n* = -9 to 0 Store number

Returns:- *m* where *m* = 0 to -55

Stored Receiver Multiple Timeslot Selection Query

Queries the receiver timeslot (2 Mb/s or 704 kb/s) selection of the instrument for the particular store requested. This takes the ASTX selection of the

receiver timeslots into account. The response corresponds with the RTM command.

SRTM? *n* *n* = -9 to 0 Store number

Returns:- "*mask*" where "*mask*" = 10 or 31 characters 0 or 1

Stored Receiver Single Timeslot Query

Queries the receiver single timeslot of the instrument for the particular store requested. The response corresponds with the RTS command.

SRTS? *n* *n* = -9 to 0 Store number

Returns:- *m* where *m* = 1 to 31

Stored Sub Rate Bearer Timeslot Query

Queries the sub rate 2 Mb/s timeslot for the particular store. The response corresponds with the SRT command.

SSRT? *n* *n* = -9 to 0 Store number

Returns:- *m* where *m* = 1 to 31

Stored Sub rate Channel Number

Queries the sub rate channel number for X.58 PTT-NL for a particular store. The response is as for CCN?

SCCN? *n* *n* = -9 to 0 Store number

Returns:- *m* where *m* = 1 to 106

Stored Bit Error Result Query

This command requests one of the stored bit error results for the particular store requested. The format of the result returned will depend upon the selected result.

9-106 Remote Control

SRSB? <i>n,m</i>	<i>n</i> = -9 to 0	Store number
	<i>m</i> = 1 or EC	Error count
	2 or EFS	Error free seconds
	3 or ER	Average error ratio
	5 or PCEFS	% Error free seconds

Returns:-

<i>flag,oor,n</i>	<i>flag</i> = 0 or 1	Validity Flag
	<i>oor</i> = 1	Inrange
	<i>n</i> = 0 to 999999	EC, EFS < 1000000
	<i>n</i> = 1.000E+6 to 9.999E+99	EC, EFS ≥ 1000000
	<i>n</i> = 0 to 1.000E+00	ER result
	0.00000 to 100.00000	PCEFS

Stored Code Error Result Query

This command requests one of the stored code error results for the particular store requested. The format of the result returned will depend upon the selected result.

SRSC? <i>n,m</i>	<i>n</i> = -9 to 0	Store number
	<i>m</i> = 1 or EC	Error count
	2 or EFS	Error free seconds
	3 or ER	Average error ratio
	5 or PCEFS	% Error free seconds

Returns:-

<i>flag,oor,n</i>	<i>flag</i> = 0 or 1	Validity Flag
	<i>oor</i> = 1	Inrange
	<i>n</i> = 0 to 999999	EC, EFS, PCEFS < 1000000
	<i>n</i> = 1.000E+6 to 9.999E+99	EC, EFS, PCEFS ≥ 1000000
	<i>n</i> = 0.0 to 1.000E+00	ER

Stored Frame Error Result Query

This command requests one of the stored frame error results for the particular store requested. The format of the result returned will depend upon the selected result.

SRFE? <i>n,m</i>	<i>n</i> = -9 to 0	Store number
	<i>m</i> = 1 or EC	Error count
	2 or EFS	Error free seconds
	3 or ER	Average error ratio
	5 or PCEFS	% Error free seconds

Returns:-

<i>flag,oor,n</i>	<i>flag</i> = 0 or 1	Validity Flag
	<i>oor</i> = 1	Inrange
	<i>n</i> = 0 to 999999	EC, EFS, PCEFS < 1000000
	<i>n</i> = 1.000E+6 to 9.999E+99	EC, EFS, PCEFS ≥ 1000000
	<i>n</i> = 0.0 to 1.000E+00	ER

Stored CRC Error Result Query

This command requests one of the stored CRC error results for the particular store requested. The format of the result returned will depend upon the selected result.

SRCR? <i>n,m</i>	<i>n</i> = -9 to 0	Store number
	<i>m</i> = 1 or EC	Error count
	2 or EFS	Error free seconds
	3 or ER	Average error ratio
	5 or PCEFS	% Error free seconds

Returns:-

<i>flag,oor,n</i>	<i>flag</i> = 0 or 1	Validity Flag
	<i>oor</i> = 1	Inrange
	<i>n</i> = 0 to 999999	EC, EFS, PCEFS < 1000000
	<i>n</i> = 1.000E+6 to 9.999E+99	EC, EFS, PCEFS ≥ 1000000
	<i>n</i> = 0.0 to 1.000E+00	ER

Stored REBE Error Result Query

This command requests one of the stored REBE error results for the particular store requested. The format of the result returned will depend upon the selected result.

SRRE? <i>n,m</i>	<i>n</i> = -9 to 0	Store number
	<i>m</i> = 1 or EC	Error count
	2 or EFS	Error free seconds
	3 or ER	Average error ratio
	5 or PCEFS	% Error free seconds

Returns:-

<i>flag,oor,n</i>	<i>flag</i> = 0 or 1	Validity Flag
	<i>oor</i> = 1	Inrange
	<i>n</i> = 0 to 999999	EC, EFS, PCEFS < 1000000
	<i>n</i> = 1.000E+6 to 9.999E+99	EC, EFS, PCEFS ≥ 1000000
	<i>n</i> = 0.0 to 1.000E+00	ER

Stored Bit Analysis Measurement Parameters Query

This command requests the conditions under which the stored bit analysis results were made, whether the measurements were performed with fixed or programmed thresholds and whether the bit measurement was standard or annex-D.

SRAT? <i>n</i>	<i>n</i> = -9 to 0	Store number
----------------	--------------------	--------------

Returns:-

<i>flag,oor,n</i>	<i>flag</i> = 0 or 1	Validity Flag
	<i>oor</i> = 1	Inrange
	<i>n</i> = 1	Standard measurement using fixed thresholds
	<i>n</i> = 2	Standard measurement using user thresholds
	<i>n</i> = 3	Annex-D measurement using fixed thresholds
	<i>n</i> = 4	Annex-D measurement using user thresholds

Stored Bit Analysis Result Query

This command requests one of the stored bit analysis results for the particular store requested. The format of the result returned will depend upon the selected result.

SRBA? <i>n,m</i>	<i>n</i> = -9 to 0	Store number
	<i>m</i> = 1 or UAS	Unavailable seconds
	2 or PCUAV	% Unavailable seconds
	3 or ES	G.821 error seconds
	4 or PCES	G.821 % error seconds
	5 or SES	G.821 severely error seconds
	6 or PCSES	G.821 % severely error seconds
	7 or DM	Degraded minutes
	8 or PCDM	% Degraded minutes
	9 or LTMER	Long Term Mean Error Ratio

Returns:-

<i>flag,oor,n</i>	<i>flag</i> = 0 or 1	Validity Flag
	<i>oor</i> = 1	Inrange
	<i>n</i> = 0 to 999999999	Seconds, minutes results
	<i>n</i> = 0.00000 to 100.00000	Percentage result
	<i>n</i> = 0.0 to 1.000E+00	LTMER result

Stored Frame Analysis Result Query

This command requests one of the stored frame analysis results for the particular store requested. The format of the result returned will depend upon the selected result.

SRFA? <i>n,m</i>	<i>n</i> = -9 to 0	Store number
	<i>m</i> = 1 or UAS	Unavailable seconds
	2 or PCUAV	% Unavailable seconds
	3 or ES	G.821 error seconds
	4 or PCES	G.821 % error seconds
	5 or SES	G.821 severely error seconds
	6 or PCSES	G.821 % severely error seconds
	7 or DM	Degraded minutes
	8 or PCDM	% Degraded minutes
	9 or LTMER	Long Term Mean Error Ratio

Returns:-

<i>flag, oor, n</i>	<i>flag</i> = 0 or 1	Validity Flag
	<i>oor</i> = 1	Inrange
	<i>n</i> = 0 to 999999999	Seconds, minutes results
	<i>n</i> = 0.00000 to 100.00000	Percentage result
	<i>n</i> = 0.0 to 1.000E+00	LTMER result

Stored CRC Analysis Result Query

This command requests one of the stored CRC analysis results for the particular store requested. The format of the result returned will depend upon the selected result.

SRCA? <i>n, m</i>	<i>n</i> = -9 to 0	Store number
	<i>m</i> = 1 or UAS	Unavailable seconds
	2 or PCUAV	% Unavailable seconds
	3 or ES	G.821 error seconds
	4 or PCES	G.821 % error seconds
	5 or SES	G.821 severely error seconds
	6 or PCSES	G.821 % severely error seconds
	7 or DM	Degraded minutes
	8 or PCDM	% Degraded minutes
	9 or LTMER	Long Term Mean Error Ratio

Returns:-

<i>flag, oor, n</i>	<i>flag</i> = 0 or 1	Validity Flag
	<i>oor</i> = 1	Inrange
	<i>n</i> = 0 to 999999999	Seconds, minutes results
	<i>n</i> = 0.00000 to 100.00000	Percentage result
	<i>n</i> = 0.0 to 1.000E+00	LTMER result

Stored REBE Analysis Result Query

This command requests one of the stored REBE analysis results for the particular store requested. The format of the result returned will depend upon the selected result.

SRRRA? <i>n</i>	<i>n</i> = -9 to 0	Store number
	1 or UAS	Unavailable seconds
	2 or PCUAV	% Unavailable seconds
	3 or ES	G.821 error seconds
	4 or PCES	G.821 % error seconds
	5 or SES	G.821 severely error seconds
	6 or PCSES	G.821 % severely error seconds
	7 or DM	Degraded minutes
	8 or PCDM	% Degraded minutes
	9 or LTMER	Long Term Mean Error Ratio

Returns:-

<i>flag,oor,n</i>	<i>flag</i> = 0 or 1	Validity Flag
	<i>oor</i> = 1	Inrange
	<i>n</i> = 0 to 999999999	Seconds, minutes results
	<i>n</i> = 0.00000 to 100.00000	Percentage result
	<i>n</i> = 0.0 to 1.000E+00	LTMER result

Stored Alarm Seconds Result Query

This command requests one of the stored alarm seconds results for the particular store requested.

SALR? <i>n,m</i>	<i>n</i> = -9 to 0	Store number
	<i>m</i> = 1 or POWER	Power loss
	2 or SIGNAL	Signal loss
	3 or AIS	AIS
	4 or FRAME	Frame loss
	5 or CRCMFM	CRC Mframe loss
	6 or CASMFM	CAS Mframe loss
	7 or PATTERN	Pattern sync loss
	8 or OCTET	Octet loss (codirectional)
	9 or REMOTE	Remote alarm
	10 or RMTMFM	Remote Mframe alarm
	11 or SUBFRAME	Sub rate frame loss
	12 or SUBREMOTE	Sub rate remote alarm

Returns:-

9-112 Remote Control

<i>flag,oor,n</i>	<i>flag</i> = 0 or 1	Validity Flag
	<i>oor</i> = 1	Inrange
	<i>n</i> = 0 to 999999999	Seconds results

Stored Elapsed Time Result Query

This command requests the stored elapsed time result for the particular store requested.

SELP? *n* *n* = -9 to 0 Store number

Returns:-

<i>flag,dd,hh,mm,ss</i>	<i>flag</i> = 0 or 1	Validity Flag
	<i>dd</i> = 0 to 99	Days
	<i>hh</i> = 0 to 23	Hours
	<i>mm</i> = 0 to 59	Minutes
	<i>ss</i> = 0 to 59	Seconds

Stored M.2100 results query

Queries a particular store for the M.2100 results.

SM2100? <i>n,path,meas,result</i>	<i>n = path</i> = -9 to 0	Store number
	<i>meas</i> = 1 or RX	Receive path
	2 or TX	Transmit path
	<i>result</i> = 1 or IS	In service
	2 or OOS	Out of service
	1 or ES	Errored seconds
	2 or SES	Severely errored seconds
	3 or UAS	Unavailable seconds

The response corresponds to the M2100? command.

Stored M.2110 pass/fail query

Queries a particular store for the M.2110 results.

SM2110? *n,m* *n* = -9 to 0 Store number
 m = 1 or DAY One day result
 2 or WEEK Seven day result

The response corresponds to the M2110? command.

Stored M.2120 report count query

Queries a store for the particular M.2120 TR1 (15-minute) and TR2 (24-hour) reports. The response corresponds to the M2120? command. The syntax is:

SM2100? *n,duration,path* *n = duration* -9 to 0 Store number
 = 1 or TR1 15 minute duration
 = 2 or TR2 24 hour duration
 path = 1 or RX Receive path
 2 or TX Transmit path

Stored Slip (estimated) Result Query

This command requests the slip result for the particular store requested

SRSP? *n,m* *n* = -9 to 0 Store number
 m = 1 or NEGATIVE Negative result
 2 or POSITIVE Positive result

Returns:-

flag,oor,n *flag* = 0 or 1 Validity Flag
 oor = 0 to 2 0: Underrange, 1: Inrange, 2: Overrange
 n = 0 to 9999999 (estimated) slip count
 n =

Stored (peak) Wander Result Query

This command requests the wander result for the particular store requested

SRWD? *n,m* *n* = -9 to 0 Store number
 m = 1 or NEGATIVE Negative result
 2 or POSITIVE Positive result

Returns:-

flag,oor,n *flag* = 0 or 1 Validity Flag
 oor = 0 to 2 0: Underrange, 1: Inrange, 2: Overrange
 n = 0 to 9999999 Peak wander
 n =

Default Conditions

The following settings are used for the instrument following backup RAM failure. The RST command and RCL 0 command reset the instrument to these conditions (except remote control and system defaults).

System: (Unaffected by RCL 0)

SRQ mask register	ERR
Status Registers A and B	LCL*, RDY
Ready Register	RAC, ASC, STC, LQE
Error register	0
Alarm mask register	0
Key register	0

Transceiver Settings:

Application	2 Mb/s
Interface	TERNARY
Linecode	HDB3
Octet Timing	ON
Binary Clock Tx	Positive Edge
Binary Clock Rx	Negative Edge
Frame	CAS MFM (2 Mb/s) or ON (704 kb/s)
Through Mode	OFF
TX Clock Source	INTERNAL
Pattern	2 ¹⁵ -1 PRBS
Tx/Rx Multiple Timeslot	T/S-1 Only
Tx/Rx Single Timeslot	1
Receive Timeslot	AS PER TX
Alarm Generation	OFF
Error Add	BIT SINGLE
Sub-rate Bearer Rate	2 Mb/s
Sub-rate Channel Number	1
Sub-rate Deselected Octets	11111111

Frame Simulation:

Test	FAS Word
Error Mode	Burst (1 Error)

Timeslot Access:

Drop & Insert	Datcom Channel
Insert To	Timeslot-1 (Off)
Drop From	Timeslot-1
Speaker	Off

2 Mb/s Timeslot-0&16 Bits:

Si Non-CRC4	"1"
Si E-bits	"11"
Sa Bits	"11111"
CAS MFM Bits 5,7,8	"111"
CAS MFM ABCD Bits	"0101"

704 kb/s Timeslot-0 Bits:

Si Bits	"1"
Sa Bits	"11111"
CAS MFM Bits 5,7,8	"111"
CAS MFM ABCD Bits	"0101"
CAS MFM Service Fm-13	"11111111"
CAS MFM Service Fm-15	"11111111"

Results Control:

Result	BER Measurements
Display (Timeslot Monitor)	Data T/S-1
Test Period	Manual
Test Period (Preset)	15 mins
Test Period (Single-User)	30 mins
Storage	Off
Sub-rate Monitor	Data Octet 1

RS-232 Port:**

RS-232	COMPUTER CONTROL
Connection	HARDWIRED
Xon/Xoff	RX & TX
Enq/Ack	OFF
Speed	9600bd
Parity	ODD
Stop Bits	1
(HP-IB Address)	5)

Printer:**

Protocol	XON-XOFF
Speed	9600bd
Stop Bits	1
Print Style	Compress

Analysis Control:

Analysis Type	G.821 Standard
Threshold Type	Fixed
SES Thrhld - Bit	1E-3
SES Thrhld - Frame	1E-3
SES Thrhld - CRC	128 in 1000
SES Thrhld - REBE	128 in 1000
Deg Min Thrhld - Bit	1E-6
Deg Min Thrhld - Frame	1E-6
Deg Min Thrhld - CRC	32 in 1000
Deg Min Thrhld - REBE	32 in 1000

Other Functions:

Stored Setting Number	0
Stored Setting Lock	ON
Deselected Timeslots	PRBS 2 ⁶ -1
Beep On Error	OFF
Keyboard Lock	OFF
Real Time Clock Mode	RUN
Self-test Function	ALL

* This default only after power on.

** These settings unaffected by RST or RCL 0 but are set to these values following non-volatile memory failure.

Status Registers

STATUS REGISTER A

This register is accessed by the STA? command and contains a 16 bit word describing the instrument's status. Nine of the sixteen bits are defined by the document *HP practice for common capabilities* of 8 August 1983, while the other seven are instrument dependent (indicated below). Each bit is a latched record of an event (not an instantaneous reading). The cause of setting and method of clearing is described below :-

DB15	DB14	DB13	DB12	DB11	DB10	DB9	DB8
0	SMG	DAT	TIP	0	SCA	ALC	EOT

DB7	DB6	DB5	DB4	DB3	DB2	DB1	DB0
MSG	RQS	ERR	RDY	LCL	FPS	PWR	RQC

- Bit 0 RQC : For compatibility with "common capabilities". Not used in this instrument. Always '0'.
- Bit 1 PWR : For compatibility with "common capabilities". The instrument is about to power down or the battery (where fitted) is in a low state of charge.
- Bit 2 FPS : Front panel service request. A front panel key has been pressed. Cleared by KEY?, RST or CLR or the meta messages \$DCL, \$\$SDC (HP-IB) or (break) (RS-232).
- Bit 3 LCL : Local operation. This is set when the power has just been cycled. Cleared by STA?, STB?, CLR or RST or the meta messages \$DCL, \$\$SDC (HP-IB) or (break) (RS-232).
- Bit 4 RDY : This bit is a direct reflection of the DRO bit (bit 3) of the ready register. (See RDY? and the ready register).

- Bit 5 ERR : Error. A remote control or self-test error of some description has occurred (see ERR? command and Error Code listing for further information). Cleared by ERR?, CLR or RST or the meta messages \$DCL, \$SDC (HP-IB) or (break) (RS-232). Some errors, such as ROM checksum, will not go away until the ROM is changed.
- Bit 6 RQS : Service requested. This bit is primarily intended for instruments fitted with HP-IB and is set if an SRQ is generated. In instruments running under RS-232 remote control the bit will still behave as described under the RQS command. Cleared by STB?, RST, CLR or the meta messages \$DCL, \$SDC and serial poll (HP-IB) or (break) (RS-232).
- Bit 7 MSG : For compatibility with "common capabilities". There is an ASCII string in the display area or the instrument has something to say. Not used in this instrument - always reads as 0.
- Bit 8 *EOT : End of testing. This bit is set when the instrument reaches the end of its test period, whether it is manual or single. NOTE: There may be a delay of up to 200ms between the actual end of the test period and this bit being set cleared at the start of any test period by STR or by RST, CLR or the meta messages \$DCL, \$SDC (HP-IB) or (break) (RS-232) or any query command requesting measurement results. This bit can be used to determine when it is safe to send configuration commands which may be locked out due to testing.
- Bit 9 *ALC : Alarm change. This is set when any of the alarms in the alarm status register change and the corresponding bit in the alarm mask register is enabled, (see ALM? and AMR). Cleared by ALM?, RST or CLR or the meta messages \$DCL, \$SDC (HP-IB) or (break) (RS-232).
- Bit 10 *SCA : Scan Trouble detected. Set when the trouble scan has found an error in one of the five basic telecom error sources; bit, code, frame, crc or rebe or a status alarm was active. This is similar in scope to the latching of relevant alarm status register bit during testing. Cleared by STR, RST, CLR or the meta messages \$DCL, \$SDC (HP-IB) or (break) (RS-232).

- Bit 12 *TIP : Test in progress. This bit is set on receipt of a STR command to indicate that the instrument has started testing and no further configuration commands will be accepted. There may be a delay of up to 200ms between this bit being set and the actual start of testing. (The ready register OST bit can be used to determine when the instrument's counters are actually counting). Cleared at the end of any test period by STP or by RST. This bit can be used to determine when it is safe to send configuration commands and when end of test results are available.
- Bit 13 *DAT : Datacom application. This bit is set if, when the datacom lid option is fitted, the instrument is in datacom application mode.
- Bit 14 *SMG : Busy downloading information into its SMG store. Stored measurement information can only be accessed when this bit is clear.
- Bit 15 0 : Zero. This is included to be compatible with "common capabilities" and is used to ensure a positive number for STA? response in 16 bit computers.

* = Instrument dependent status bits

Each of the bits in this register (excluding bit 6) can give rise to a change of state of bit 6 (RQS) and hence in the case of instruments with HP-IB capability, can generate an SRQ dependent upon the state of the SRQ mask setting. The RQS command is used to set the SRQ mask which has bits identical to that in status register A. An SRQ, and hence a change of state of the RQS bit, is generated on the positive edge of any bit in status register A if the corresponding bit in the SRQ mask is set. If the function is disabled by the RQS OFF command, any positive transitions of a source with its mask bit enabled will be caught and SRQ'd when the RQS ON command is sent.

STATUS REGISTER B

This register is accessed by the STB? command (or a serial poll in the case of HP-IB) and contains an 8 bit word describing the important instrument status information. Each bit is a latched record of an event (not an instantaneous reading). The causes of setting and method of clearing are described below:-

DB7	DB6	DB5	DB4	DB3	DB2	DB1	DB0
0	RQS	ERR	RDY	LCL	FPS	ALC	EOT

- Bit 0 *EOT : End of testing. This bit is set when the instrument reaches the end of its test period, whether it be manual or single. NOTE: There may be a delay (can be in the order of hundreds of ms) between the actual end of the test period and this bit being set cleared at the start of any test period by STR or by RST, CLR or the meta messages \$DCL, \$SDC (HP-IB) or (break) (RS-232) or any query command requesting measurement results. This bit can be used to determine when it is safe to send configuration commands which may be locked out due to testing.
- Bit 1 ALC : Alarm change. This is set when any of the alarms in the alarm status register change and the corresponding bit in the alarm mask register is enabled, (see ALM? and AMR). Cleared by ALM?, RST or CLR or the meta messages \$DCL, \$SDC (HP-IB) or (break) (RS-232).
- Bit 2 FPS : Front panel service request. A front panel key has been pressed. Cleared by KEY?, RST or CLR or the meta messages \$DCL, \$SDC (HP-IB) or (break) (RS-232).
- Bit 3 LCL : Local operation. This is set when the power has been cycled. Cleared by STA?, STB?, CLR or RST or the meta messages \$DCL, \$SDC (HP-IB) or (break) (RS-232).
- Bit 4 RDY : This bit is a direct reflection of the DRO bit (bit 3) of the ready register. (See RDY? and the ready register).

- Bit 5 ERR : Error. A remote control or self-test error of some description has occurred (see ERR? command and Error Code listing for further information). Cleared by ERR?, CLR or RST or the meta messages \$DCL, \$SDC (HP-IB) or (break) (RS-232). Some errors, such as ROM checksum, will not go away until the ROM is changed.
- Bit 6 RQS : Service requested. This bit is primarily intended for instruments fitted with HP-IB and is set if an SRQ is generated. In instruments running under RS-232 remote control the bit will still behave as described under the RQS command. Cleared by STB?, RST, CLR or the meta messages \$DCL, \$SDC and serial poll (HP-IB) or (break) (RS-232).

READY REGISTER

This register is accessed using the RDY? command. The ready register is a byte with binary weighted bits assigned as follows :-

DB7	DB6	DB5	DB4	DB3	DB2	DB1	DB0
0	LQE	STC	ASC	DRO	AOC	OST	RAC

- Bit 0 RAC : Ready to accept new command. This bit is included for “common capabilities” and is not used in this instrument. This bit will always appear set.
- Bit 1 OST : Operation started, this bit is set when the instrument starts testing and reset when it has stopped. The flag reflects the actual start of measurement timing but it is not an indication of when results are available or when configuration commands are permitted (see status-A EOT or TIP flags).
- Bit 2 AOC : All operations complete. This bit is included for common capabilities and is not used in this instrument. This bit will always appear clear.
- Bit 3 DRO : Data ready for output. This bit is set while a command is outputting data on reply to a query command and is included for common capabilities but has no real use in this instrument. However, the RDY bit in status registers A and B directly follow this bit and a positive transition of the former will generate an SRQ (HP-IB) and change of state of status A RQS bit if its mask is enabled. On reads of these registers this bit will always appear set.
- Bit 4 ASC : Auto-setup complete. This bit is cleared following a request for auto-setup, and set on completion of that setup.
- Bit 5 STC : Self-Test complete. This bit is cleared following a request for self test, and set on test complete.
- Bit 6 LQE : Logging (Printer) Queue Empty. This bit is clear while there is data present in the instrument’s internal printer output buffer and set when this buffer is empty. NOTE: No account is taken of buffering within an external printing device.

ALARM REGISTER

This register is accessed by the ALM? command. The format shown below for the alarm register also applies to the alarm change register, the alarm history register and the alarm mask register. A "1" in a bit position indicates that the specified condition is prevailing. If a given alarm condition changes and the corresponding bit in the Alarm Mask Register (see AMR) is a "1", then the Alarm Change (ALC) bit will be set in Status Registers A & B. Note that for instruments fitted with and under HP-IB control this may generate an SRQ (and set status A RQS) if the ALC bit in the RQS mask register (see RQS) is a "1". The execution of this command clears the ALC bits in status registers A and B.

DB15	DB14	DB13	DB12	DB11	DB10	DB9	DB8
0	RDI	SRM	SFM	UAV	PWL	RFM	REM

DB7	DB6	DB5	DB4	DB3	DB2	DB1	DB0
OCT	ERR	PAT	CAS	CRC	FML	AIS	SGL

- Bit 0 SGL : Signal loss. Set when no signal is present at the selected input port.
- Bit 1 AIS : Alarm Indication Signal. Set when a signal corresponding to an alarm indication signal is present at the selected input port.
- Bit 2 FML : Frame loss. Set when frame sync is lost while framing is selected at 2 Mb/s or 704 kb/s (where fitted). Clear outwith this criterion.
- Bit 3 CRC : CRC Multiframe loss. Set when CRC multiframe sync is lost while 2 Mb/s CRC4 framing is selected. Clear outwith this criterion.
- Bit 4 CAS : CAS Multiframe loss. Set when CAS multiframe sync is lost while 2 Mb/s CAS frame type is selected or 704 kb/s framing is selected. Clear outwith this criterion.
- Bit 5 PAT : Pattern loss. Set when pattern loss occurs for any application with the receiver pattern set to other than live data. Clear outwith this criterion.

- Bit 6 ERR : Errors detected. Set if any basic error in context (bit, code, frame, CRC, REBE) has occurred in the last 100ms.
- Bit 7 OCT : Octet loss. Set if octet loss occurs while receiving a 64 kb/s codirectional input signal. Clear outwith this criterion.
- Bit 8 REM : Remote alarm. Set when remote alarm is detected for any 2 Mb/s or 704 kb/s frame type. Clear outwith this criterion.
- Bit 9 RFM : Remote multiframe alarm. Set when remote multiframe alarm is detected for any 2 Mb/s CCS frame type or for 704 kb/s framing. Clear outwith this criterion.
- Bit 10 PWL : Power Loss. This history flag is set if the power has failed during the last or current test period. Cleared at the start of the next test period.
- Bit 11 UAV : Unavailability. This flag is set during testing if the system under test is deemed unavailable for any one of bit, frame, crc or rebe availability measurements (where applicable). The system under test is deemed available at the start of testing and the flag remains as history at the end of testing.
- Bit 12 SFM : Sub-rate frame loss. Set when sub-rate frame sync is lost during sub rate operation. Clear at all other times.
- Bit 13 SRM : Sub rate remote alarm. Set when a distant/remote alarm is detected for sub rate structures X.50 div 2, X.50 div 3, and X.58 CCITT for application sub rate (where fitted).Clear at all other times.
- Bit 14 RDI : RX data inverted. Set when pattern sync is gained with a PRBS of the opposite polarity to that selected. Clear at all other times. Does not apply to subrate PRBS patterns.

Notes:

- (a) UAV bit only changes during test periods, it has no meaning otherwise other than as a measurement result during and after testing.
- (b) Bits 0-12 are direct reflections of the corresponding front panel leds where fitted.
- (c) The PWL bit will be set if power fails during a test interval. It will be reset upon starting of the next test.

HP-IB Operation

The standard T1 and Datacom Testers are provided with RS-232 printer output and remote control.

The special option H02 instruments are provided with Hewlett-Packard Interface Bus (HP-IB) printer output and remote control.

This section covers the additional information required for HP-IB operation.

The printing and control information, including commands, apply to both RS-232 and HP-IB. The variations in setting up the instrument for HP-IB operation are given in this section.

HP-IB Provides a parallel interface which allows the instrument to be incorporated into a system by the connection of other devices, for example : a Personal Computer or a Printer. Such a system allows great flexibility in communicating and controlling data.

The performance of the instrument may be extended by storing a greater number of test set-ups in the controller (or on disc) and loading them into the instrument as required. Similarly a greater number of results may be returned to the controller or printer for later analysis.

If long distance communication is required, suitable HP-IB Extenders are available. HP-IB Extenders are connected within the test system at both ends of the communication link.

Connecting to the HP-IB

The following points should be considered when connecting the instrument to the HP-IB :

- Operating distances
- Communication with the system controller

Operating Distances

To achieve interface design performance standards, restrictions are placed on the HP-IB system cable lengths. These restrictions allow the bus interface to maintain correct line voltage levels and timing relationships.

When connecting an HP-IB system the following rules should be observed :-

1. The total length of HP-IB cable must not exceed 2 meters (6 feet) \times the number of devices in the system.
2. The total length of HP-IB cable, used to interconnect all devices in the system, must not exceed 20 meters (65 feet).

Hewlett-Packard Interface Bus Connector

A standard HP-IB connector is provided on the instrument rear panel. The connections and HP-IB logic levels are shown in the following figure. The Mating connector part number is HP 1251-0293 or Amphenol 57-30240.

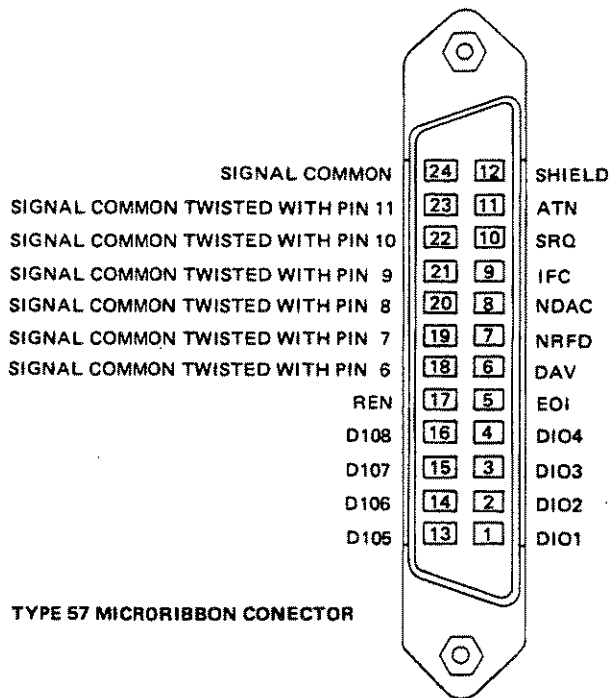

Figure 9-1. HP-IB Connections and Logic Levels

Suitable Cables

The instrument may be connected to the HP-IB with one of the following HP-IB cables.

Table 9-2. HP-IB Interconnecting Cables

Length	Accessory Number
1 meter	10833A
2 meters	10833B
4 meters	10833C
0.5 meter	10833D

Connection Over Greater Distances

Operating distances can be increased by using HP-IB Extenders, HP 37204A or HP 37201A :

Up to 1250 meters use HP 37204A.

Over 1250 meters use two HP 37201A and two suitable Modems.

Setting Up for Printing or Controlling

A printout of alarms, results and instrument settings may be obtained by connecting a printer to the HP-IB connector and selecting the TALK ONLY mode of operation.

Instrument/system control may be obtained by connecting a controller to the HP-IB connector and selecting the ADDRESSABLE mode of operation.

To Print using Talk Only

Press **AUX**

Select **PRINTER / REM CTL**

Highlight HP-IB MODE **[]**

Select **TALK ONLY**

Use the information in the Operating and Calibration Manual, chapter 6, Printing Results to set the instrument for the type of print you want.

To Control the Instrument Remotely

Communication with the System Controller

Each device in the system must have a unique address to allow the controller to access it individually. The address is selectable from the instrument front panel.

HP-IB Address Selection

To select the HP-IB address:

Press **AUX**

Select **PRINTER / REM CTL**

Highlight HP-IB MODE []

Select **ADDRESSABLE**

Highlight ADDRESS []

Select a "system unique" address in the range 1 to 30

To Return to Local Operation

There are two alternative methods of returning to local operation from remote:

By sending the LCL command

By selecting **AUX**, **PRINTER / REM CTL**, **RETURN TO LOCAL**

Status Reporting

The instruments contains 5 Registers which can be interrogated for status information. Two Status registers, A and B, Alarm register, Ready register and Error register.

To determine the current status of the instrument you must interrogate the Primary Status Byte register, Status register B. Three methods of interrogation are possible via HP-IB but only one method is available via RS-232. The three methods and the remote interface on which they are valid are listed below.

Method of Interrogation	HP-IB	RS-232
Poll using STB?	YES	YES
Repeated Serial Poll (SPOLL)	YES	NO
Poll using a Service Request interrupt routine	YES	NO

Service Request Interrupt Routine

- Select the condition(s), under which you require the instrument to Request Service by using the "RQS n" command.
- Specify the action to be taken when an interrupt is issued by using the controller dependent ENABLE INTR and ON INTR (Basic) statements.
- Acquire the Primary Status Byte using the SPOLL (basic) statement.

The printer/ remote control display used for setting the HP-IB address, gives a service request indication.

Poll Using STB?

- Select the condition(s), under which you require the instrument to Request Service by using the "RQS n" command.
- Enter a waiting loop and acquire the Primary Status Byte by using the "STB?" command.

HP-IB Capability

SH1	(complete capability)
AH1	(complete capability)
T5	(Basic talker, serial poll, talk only mode, unaddress if MLA)
TE0	(No extended talker capability)
L4	(Basic listener, unaddress if MTA)
LE0	(No extended listener capability)
SR1	(Complete SRQ capability)
RL1	(Complete remote-local capability)
PP0	(No parallel poll capability)
DC1	(Complete device clear capability)
DT0	(No device trigger capability)
C0	(No controller capability)

HP-IB Universal Commands

- DEVICE CLEAR
- SELECTIVE DEVICE CLEAR
- INTERFACE CLEAR
- REMOTE ENABLE
- LOCAL
- LOCAL LOCKOUT

Device Clear and Selective Device Clear (SDC)

These commands are usually sent at the beginning of a program to reset the HP-IB interface of the instrument to a known state without changing the panel settings :

- All buffers flushed
- Stop asserting SRQ
- Service request mask set to ERR (32)
- Clear all errors
- Clear status and key registers
- Ready register RAC bit set

Device Clear using an HP 200 series controller is : CLEAR 7 (Where 7 is the Bus I/O select code).

Selective Device Clear using an HP 200 series controller is : CLEAR 705 (Where 7 is the Bus I/O code and 05 is the device address).

Interface Clear (IFC)

This command clears the HP-IB interface and returns the instrument to the listener idle state; it does not affect the parser or any of the internal buffers of the instrument.

Instrument Clear command using an HP series 200 controller is : ABORT 7 (Where 7 is the Bus I/O select code).

Remote Enable (REN)

The Remote Enable command instructs the instrument to accept instruction via the HP-IB. The instrument will accept commands while in local mode only if they do not change the configuration of the instrument. When the instrument receives the remote enable command, the front panel REMOTE indicator comes on.

It is highly recommended that the instrument be put into the remote with local lockout state (RWLS) when being controlled via the HP-IB. This will disable the front panel LOCAL selection and guarantee that the system controller has sole control of the instrument at all times. To do this the controller should send the REN command followed by the LLO command.

When in RWLS, selecting **AUX**, **PRINTER / REM CTL**, RETURN TO **LOCAL** will cause bit 2 (FPS) of the status byte to be set, generating an SRQ if the SRQ mask is enabled. It is then at the discretion of the controller whether to return the instrument to local control or ignore the request.

Local (LCL)

The instrument can be returned to the local state from the remote state by selecting **AUX**, **PRINTER / REM CTL**, RETURN TO **LOCAL**, or by sending the LCL command from the controller.

Local command using an HP series 200 controller is : LOCAL 705 (Where 7 is the Bus I/O select code and 05 is the device address).

The Local command (LCL) overrides Local Lockout.

Error Codes

Within this section are listed all the error codes for the instrument. They are separated into common capability and instrument dependent, and are accessed by the ERR? command.

Common Capability Errors

The error codes that appear under this section are the recommended error numbers as defined in the document *Reserved HP-IB Commands*, recommended practice for common capabilities. They are divided into three sections, although there may be a few instrument dependent error codes appearing under these sections also. They are indicated by an asterisk.

Parse Time Errors (Error codes -100 to -199)

The errors listed here occur during the parsing of remote commands.

-100	Command error (Unknown command)
-101	Invalid character received
-110	Command header error
-111	Header delimiter error
-120	Numeric argument error
-121	Wrong data type (Numeric expected)
-122	Precision error; rounding occurred
-123	Numeric overflow
-129	Missing numeric argument
-130	Non numeric argument error (mnemonic not recognized)
-131	Wrong data type (char expected)
-132	Wrong data type (string expected)
-133	Wrong data type (block type #A required)
-134	Data overflow : string or block too long
-135	Error in #H block
-139	Missing non numeric argument
-141	Command buffer overflow
-142	Too many arguments
-143	Argument delimiter error
-144	Invalid message unit delimiter
-150	Unexpected EOI
-151	CR found without following LF
-160*	RS-232 Parity Error
-161*	RS-232 Framing Error
-162*	RS-232 UART Overrun Error
-163*	RS-232 Internal Input Buffer Overrun Error

* = Instrument dependent error code.

Execution Time Errors (Error codes -200 to -299)

These errors are caused at execution time of remote control commands.

-200	No can do (generic execute error)
-201	Not executable in local mode
-202	Settings lost due to RTL or PON
-203	Trigger ignored
-211	Legal command, but settings conflict
-212	Argument out of range
-221	Busy doing something else
-222	Insufficient capability or configuration
-231	Input buffer full or overflow
-232	Output buffer full or overflow
-240	command provided through meta message only (HP-IB)
-241	Command not implemented
-243	Command not executable while remote
-250	Command illegal during testing
-251	Command illegal when not testing
-252	Commands in incorrect sequence
-260	Reserved

Stored Measurement Results and Graphics Errors (Error codes -410 to -499)

-410	Not allowed while SMG running
-411	Requested SMG store out of range
-412	Requested SMG store unused - no data
-413	Requested SMG text result out of range

Option or Capability Errors (Error codes -600 to -699)

The error codes in this section are issued if a legal command is received, but it cannot be executed due to insufficient capability or unsuitable option configuration. They are all diagnosed by the remote control parser or executor.

- 600* Instrument has no timeslot access option fitted
- 601* Instrument has no 704 kb/s interfaces fitted
- 602* Instrument has no 8 Mb/s interfaces fitted
- 603* Instrument has no HP-IB interface fitted
- 604* Not running under battery power
- 607* Instrument has no accessory fitted
- 608* Command only permitted in RS-232 operation
- 609* Command only permitted in HP-IB operation
- 613* Sub rate option not fitted
- 614* Tones option not fitted
- 615* Enhanced M2100 option not fitted (see note below)
- 616* Relative frequency option not fitted

* = Instrument dependent error code.

Note: The following commands are dependent on option 210: TTY timed, MPA, MPA?, L2110?, L2120?, M2110?, M2120?, SM2110?, and SM2120?

Self-Test Errors (Error codes 1 to 15999)

There is only one self-test error, which indicates that the instrument has failed one of the tests specified in the TST command. No errors are reported by the power-on tests. Test failure is indicated by a fail code. Fail codes are grouped to indicate the test which has failed. More detailed information is supplied in the service documentation.

Fail Code Group	Test	Test Number
1 to 1099	CPU	1
2000 to 2999	Pattern	2
3000 to 3999	Frame	3
4000 to 4999	Line Code	4
5000 to 5999	Timeslot	5
6000 to 6999	Error Add	6
7000 to 7999	Frame Error	7
8000 to 8999	Alarms	8
9000 to 9999	Signal	9
10000 to 10999	Bit	10
11000 to 11999	Clock Recovery	11
12000 to 12999	Sub rate	12

Index

6

600 ohms audio interface selection, 3-30
64kb/s Tx, 2Mb/s Rx, test example,
3-13

A

Accessories Available, 6-3
Accessories Supplied, 6-3
ACCESSORY Port, 7-7
A/D performance, test example, 3-30
After Getting Started, 1-15
Alarm Change Status Query, ALC?,
9-92
Alarm Generation, ALG, 9-66
Alarm Generation, Error Addition and
Frame Simulation Commands, 9-66
Alarm generation selection, 3-18
Alarm history example, 1-9
Alarm indication example, 1-9
Alarm Mask Register, AMR, 9-80
Alarm register, 9-126
Alarms display, 4-2
Alarms display, current conditions, 4-2
Alarms display, durations, 4-4
Alarms display, history, 4-3
Alarm seconds display, 4-4
Alarm Seconds Result Query, ALR?,
9-86
Alarm Status Query, ALM?, 9-92
ALC?, Alarm Change Status Query,
9-92
ALG, Alarm Generation, 9-66

ALM?, Alarm Status Query, 9-92
ALR?, Alarm Seconds Result Query,
9-86
Alternative printer, selecting output for,
5-4
AMR, Alarm Mask Register, 9-80
Analog signal testing, 3-32
Analogue measurement example, 3-34
Analysis Measurement Parameters
Query, RAT?, 9-84
Analysis Measurement Type, ANT, 9-78
Analysis threshold selection, 2-10, 2-11
Analysis Threshold Type, THT, 9-78
ANT, Analysis Measurement Type, 9-78
APP, Application Mode, 9-29
Application Mode, APP, 9-29
Audible indication of errors, 2-22
Audio Source (Beep On Error), AUS,
9-47
AUS, Audio Source (Beep On Error),
9-47
Automatic setting of frame, code and
pattern, 2-3
Auto setup, 2-3
AUT, Receiver Auto-Setup, 9-52

B

Background timeslot content, 2-12
Battery - Option B12, 7-3
BEA, Sub rate burst error length, 9-67
Beep, BEEP, 9-56
BEEP, Beep, 9-56

Beep on error, 2-22
Before Getting Started, 1-1
BEL, Frame Simulate Burst Error Length,
9-69
BEU, Frame Simulate User Defined Burst
Length, 9-69
Binary clock/data phase selection, 2-16
Binary Interface Receive Clock
Phase, RCP, 9-30
Binary Interface Transmit Clock
Phase, TCP, 9-30
BIS testing, 3-41
Bit Analysis Result Query, RBA?, 9-84
Bit error display, 4-7
Bit Error Result Query, RSB?, 9-81
Bit slips measurement, 3-71
BIT?, Timeslot Monitor Query, 9-90
BRR, Sub Rate Bearer Rate, 9-31
Burst Error Start/Stop, BUS, 9-69
BUS, Burst Error Start/Stop, 9-69

C

Calibration
cycle, 8-2
Self tests, telecom, 8-7
When to perform, 8-2
CAS Multiframe ABCD Bits Set-
Up, SAD, 9-60
CAS Multiframe Bits Set-Up, SMF, 9-60
CAS Multiframe Service Bits (704 kb/s)
Set-Up, SSV, 9-61
CCN, Sub Rate Channel Number, 9-37
CCS timeslot 16 /protocol analyzer
interface example, 3-51
Changing Battery Fuses, 7-5
Changing the Batteries, 7-4
Channel error performance test example,
3-11
Character Format - Printer/Remote
Control, 7-8

Charging the Batteries (Option B12),
7-4
Clear, CLR, 9-22
Clock/data phase selection, binary, 2-16
Clock input, external, 7-7
Clock starting, 2-21
CLR, Clear, 9-22
Code error display, 4-7
Code Error Result Query, RSC?, 9-82
Coder offset measurement, 3-34
Codeword Into NFAS Frame Bit
Enable, SAH, 9-60
Codeword Into NFAS Frame Bit
Number, SAN, 9-59
COD, Ternary Linecode, 9-30
COFA display, 4-11
COFA measurement, 3-71
COFA Result Query, RCS?, 9-88
Commands, remote control, 9-21
Communication over the line under test,
2-23
Computer, operation from, 9-5
CON, Configuration, 9-23
Configuration, CON, 9-23
Continuous Frame Error Add, FEA,
9-70
CRC4 performance evaluation example,
3-53
CRC Analysis Result Query, RCA?, 9-85
CRC error display, 4-7
CRC error monitor example, 3-53
CRC Error Result Query, RCR?, 9-83
Current alarms display, 4-2
Cursor movement, 1-4

D

Data bit monitor, sub-rate, 3-61
Data/clock phase selection, binary, 2-16
Datacom Module Connection -
ACCESSORY Port, 7-7
Datacom / T1 selection, 7-6

Datacom / Telecom selection, 2-2
Datacom / Telecom selection, 1-2
Data Drop From Timeslot, DFT, 9-39
Data Insert Timeslot Enable, DIE, 9-39
Data Insert To Timeslot, DIT, 9-38
DAT, Date Set-Up, 9-45
Date setting, 2-20
Date Set-Up, DAT, 9-45
DCC frame / multiframe sync testing, 3-22
DCC response to frame / multiframe sync loss testing, 3-22
Default conditions, 9-116
Degraded Minutes Analysis
 Threshold, THD, 9-79
Deselected timeslot content, 2-12
Deselected Timeslots Pattern, DST, 9-61
Detailed Store Use Query, SMC?, 9-97
DFT, Data Drop From Timeslot, 9-39
DIE, Data Insert Timeslot Enable, 9-39
DIS, Display On/Off, 9-56
Display bit errors, 4-7
Display code errors, 4-7
Display count of each error type, 4-6
Display CRC errors, 4-7
Display EFS or %EFS result, EFS, 9-56
Display frame errors, 4-7
Display G.821 analysis, 4-8
Displaying graphs of results, example, 1-12
Display M2100 and M2110 analysis, 4-9
Display M2100 and M2120 analysis, 4-10
Display M21XX analysis, 4-9, 4-10
Display of current alarms, 4-2
Display On/Off, DIS, 9-56
Display remote end block errors, 4-7
Display results as graphs, 4-12
Display results examples, 1-10
Display signal results, 4-11
Display, stored results, 4-15

DIT, Data Insert To Timeslot, 9-38
Drop and insert selection, 3-30
 600 Ω audio, 3-60
 datacom, 3-52
DST, Deselected Timeslots Pattern, 9-61

E

EAD, Error Add, 9-67
EAR, Error Add Ratio, 9-67
EAT, Error Add Type, 9-66
E-Bits Set-Up, SEB, 9-58
EDI, External Drop + Insert Data Source, 9-38
EFS, display EFS or %EFS result, 9-56
EFS or %EFS selection, 1-5, 2-13
Elapsed Time Result Query, ELP?, 9-89
ELP?, Elapsed Time Result Query, 9-89
ERR?, Error Code Query, 9-27
Error Add, EAD, 9-67
Error add rate example, 1-8
Error Add Ratio, EAR, 9-67
Error add, single example, 1-7
Error Add Type, EAT, 9-66
Error Code Query, ERR?, 9-27
Error Codes, 9-136
Error indication, audible, 2-22
Error performance (ISDN) monitor example, 3-57
Error performance monitor example, 3-43
Error results display selection, 4-7
Errors display, choices, 4-5
Errors display, selection, 4-6
ERR? responses, 9-136
Examples of telecom tests, 3-2
External clock input, 7-7
External Drop + Insert Data Source, EDI, 9-38
External RS-232 Printer Set-Up, PTR, 9-46

F

Far end loopback, unframed, test example, 3-4
FAS bits selection
 X.50 div 2, 2-14
 X.50 div 3, 2-14
Fast Set Up, 2-3
FEA, Continuous Frame Error Add, 9-70
FEU, User Defined Continuous Frame Error Add, 9-70
Fixed rate error add example, 1-8
Fixed set-up recall, 1-3
Frame alignment error mode and rate selection, 3-16
Frame alignment signal selection, 3-16
Frame Analysis Result Query, RFA?, 9-85
Frame bit monitor, sub-rate, 3-61
Frame error display, 4-7
Frame Error Result Query, RFE?, 9-82
Frame Hierarchy Configuration commands, 9-58
Frame / multiframe sync testing, 3-22
Frame Simulate Burst Error Length, BEL, 9-69
Frame Simulate Test Error Mode, FTM, 9-68
Frame Simulate Test Type, FTT, 9-68
Frame Simulate User Defined Burst Length, BEU, 9-69
Frame simulation selection, 3-16, 3-23
Framing bits
 Monitoring example, 3-57
 Setting example, 3-38
Framing bits selection, 2-8
Framing/Signaling bits selection for 704kbit/s Operation, 2-9
Framing Type, FRM, 9-31
Frequency generation, 3-32
Frequency offset (Rx) display, 4-11

Frequency Result Query, RSF?, 9-87
FRM, Framing Type, 9-31
FTM, Frame Simulate Test Error Mode, 9-68
FTT, Frame Simulate Test Type, 9-68
Fuses, 7-2

G

G.821 analysis display, 4-8
Getting Started, 1-2
Graph display, leaving, 4-14
Graph display of results, 4-12
Graph display resolution selection, 4-14
Graph display selection, 4-13
Graph display time window selection, 4-13
Graphs of results, example, 1-12

H

Hewlett-Packard 80 column printer, selecting output for, 5-2
HIS?, Show History Status Query, 9-54
History of alarms, example, 1-9
History of alarms in current/last test, 4-3
History Reset, HSR, 9-54
HP-IB address, 9-15
HP-IB Address, 9-132
HP-IB connector, 9-12
HP-IB Connector, 9-129
HP-IB Operation, 9-128-135
HSR, History Reset, 9-54

I

ID, Instrument Identification, 9-25
Idle timeslot finding example, 3-46
IFC, Interface Type, 9-29
Individual channel error test example, 3-11
Individual timeslot tracing, 3-9

Infrequent alarm/error monitor example,
3-43

Initial Inspection, 7-1

In Service test examples, 3-43

In service testing, list of examples, 3-3

Instrument Identification, ID, 9-25

Instrument Settings commands, 9-29

Instrument Special Option
Query, SPECIAL?, 9-57

Interface Type, IFC, 9-29

Interface with TIMS example, 3-30

Investigation of infrequent alarm and
error bursts, 3-43

Isolation of source of errors, 3-46

K

Keyboard Function commands, 9-52

Keyboard lock, 2-2

Keyboard Lock, KLK, 9-46

KEY?, Key Query, 9-23

Key Query, KEY?, 9-23

KLK, Keyboard Lock, 9-46

L

L2100, M.2100 limits, 9-40

L2110?, M.2110 limits, 9-41

L2120?, M.2120 limits, 9-42

LAN interconnection, round trip delay
test example, 3-35

LCL, Local, 9-22

LHB, Long User Word Send Left Hand
Bit, 9-50

Line Fuses, 7-2

Listen / talk selection, 2-23

Live data selection, 3-44

Local, LCL, 9-22

Local loop, unframed, test example, 3-5

Long term alarm/error monitoring
example, 3-43

Long User Word Byte Length, LUL,
9-48

Long user word, content selection, 2-6

Long User Word Pattern, LUW, 9-50

Long User Word Pattern Synchronisation
Length, LUY, 9-49

Long User Word Program
Synchronisation Length, LSL, 9-49

Long user word selection, 3-10

Long User Word selection Number, LUS,
9-48

Long User Word Send Left Hand
Bit, LHB, 9-50

Loopback with NFAS codes, example,
3-38

LSL, Long User Word Program
Synchronisation Length, 9-49

LTE frame / multiframe sync testing,
3-22

LTE response to frame / multiframe
sync loss testing, 3-22

LUL, Long User Word Byte Length,
9-48

LUS, Long User Word selection Number,
9-48

LUW, Long User Word Pattern, 9-50

LUY, Long User Word Pattern
Synchronisation Length, 9-49

M

M2100 and M2110 analysis display, 4-9

M2100 and M2120 analysis display,
4-10

M.2100 limits, L2100, 9-40

M2100?, M2100 result query, 9-93

M.2100 specifications, 6-21

M.2100 testing, 3-41

M.2100 threshold selection, 2-26

M.2110 limits, L2110?, 9-41

M.2110 testing, 3-41

M.2120 limits, L2120?, 9-42

M.2120 testing, 3-41

M.2120, TR2 limit selection, 2-26

M21XX analysis display, 4-9, 4-10
M.21XX path allocation setting, MPA,
9-42
M.21XX Specifications, 6-45
Mapping selection X.53, 2-14
Mapping, user defined, X.53, 9-62
Mating Connectors, 7-6
Measurements, full list, 3-69
Measurement timed start, 2-25
Miscellaneous commands, 9-56
Modem connection, 9-2
Monitoring of VF Traffic in Channels,
3-59
Monitoring timeslot contents, 3-9
MPA,M.21XX path allocation setting ,
9-42
Multi-frame alignment error mode and
rate selection, 3-23
Multi-frame alignment signal selection,
3-23
Multiple Timeslot Transmit and Receive
Bandwidth, RBW?, 9-93
Multiplexer remote alarm generation,
test example, 3-17
Mux A/D performance test example,
3-30
Mux / demux function test example,
3-13
Mux Performance evaluation, 3-13
Mux response to alarm conditions, test
example, 3-17
Mux thresholds test example, 3-15

N

Name Stored Setting, NAM, 9-44
Naming stored set-ups, 2-19
NAM, Name Stored Setting, 9-44
Network illustration, overall, 3-1
Network Performance Evaluation , 3-4
NFAS
Monitoring example, 3-57

Setting example, 3-38
Use for loopback example, 3-38
Word monitor example, 3-57
NFL?, Timeslot Monitor NFAS Latch
Query, 9-91
NFS?, Timeslot Monitor All NFAS Bits
Query, 9-91
NFT?, Timeslot Monitor NFAS Latch
Timestamp Query, 9-91
Non-intrusive CRC4 testing example,
3-53
N x 64kb/s end to end test example,
3-7
N x 64kb/s test pattern inserted into
live data, example, 3-48
N x 64kb/s through mode test example,
3-48

O

Operating Environment, 7-13
Operational verification
Telecom, 8-4
Operational verification test record
Telecom, 8-28
Option 210, 6-45
Option B12 - Battery, 7-3
Options Available, 6-2
Options Query, OPT?, 9-28
OPT?, Options Query, 9-28
Other-Page Functions, 9-44
Out Of Service test examples, 3-4
Out of service testing, list of examples,
3-2
Overall network illustration, 3-1

P

PAT, Pattern Type, 9-33
Pattern dependent errors example, 3-10
Pattern loss type selection, 2-26
Patterns from external sources, 3-66
Pattern slip measurement, 3-71

Pattern slips display, 4-11
Pattern Slips Result Query,RPS?, 9-89
Pattern Type,PAT, 9-33
PAU,User Defined Word Pattern, 9-34
Performance test record, 8-84
Performance tests
 Telecom, 8-30
PLS, set pattern loss threshold, 9-42
Power Cable, 7-3
Power Requirements, 7-2
PPO, PRBS polarity, 9-33
PRA, Printer auto trigger, 9-51
PRBS polarity, PPO, 9-33
Preparation for Use, 7-2
Print at timed intervals, 6-45
Printer auto trigger, PRA, 9-51
Printer choices, 5-1
Printer Output - Character Format, 7-8
Printer output selection, 5-2
Printer Port, 7-7
Printer setup example, 5-3
Printing, 5-5
Printing at timed intervals, 2-25, 5-5
Printing current results, graphic, 5-5
Printing current results, numeric, 5-5
Printing stored results, 5-9
Printing stored results, graphic, 5-11
Printing stored results, numeric, 5-10
Print Now,REMLOG?, 9-55
Programming tips, 9-19
Protocol analyzer interface, 3-66
Protocol analyzer interface example,
 3-51
PTR,External RS-232 Printer Set-Up,
 9-46

R

Rack Mounting, 7-10
RAT?,Analysis Measurement Parameters
 Query, 9-84
Rate, error add example, 1-8

RBA?,Bit Analysis Result Query, 9-84
RBW?,Multiple Timeslot Transmit and
 Receive Bandwidth, 9-93
RCA?,CRC Analysis Result Query,
 9-85
RCL,Recall Settings, 9-44
RCP,Binary Interface Receive Clock
 Phase, 9-30
RCR?,CRC Error Result Query, 9-83
RCS?,COFA Result Query, 9-88
RDS,Results Display Control, 9-74
RDY?,Ready Code Query, 9-27
Ready Code Query,RDY?, 9-27
Ready register, 9-125
Real time data service, round trip delay
 test example, 3-35
REBE Analysis Result Query,RRA?,
 9-86
REBE error monitor example, 3-53
REBE Error Result Query,RRE?, 9-83
REBE generation, test example, 3-19
Recall fixed set-up, 1-3
Recall Settings,RCL, 9-44
Recall stored set-up, 2-4
Received frequency display, 4-11
Receiver Auto-Setup,AUT, 9-52
Receiver Multiple Timeslot
 Selection,RTM, 9-37
Receiver Single Timeslot,RTS, 9-36
Receive Timeslot,RXT, 9-36
Receive timeslot selection, 3-7
Recommended test equipment, 8-2
Relative frequency measurement, 3-71
REMLOG?,Print Now, 9-55
Remote alarm generation test example,
 3-17
Remote Control - Character Format,
 7-8
Remote control commands, 9-21
Remote control common capability
 commands, 9-21

Remote control, direct connection, 9-3
 Remote Control Port, 7-7
 Remote control, preparation, 9-1
 Remote control status registers, 9-120
 Remote end block error display, 4-7
 Remote end block error generation, test example, 3-19
 Remote operation command example, 9-6
 Remote operation, general information, 9-6
 Remote,RMT, 9-22
 Request Service Mask,RQS, 9-24
 Reset,RST, 9-21
 Response of multiplexer to alarm conditions, test example, 3-17
 Response of multiplexer to CRC errors, test example, 3-19
 Response of multiplexer to incoming alarms, test example, 3-17
 Result Graphs, example, 1-12
 Result Query Commands, 9-81
 Results Display Control,RDS, 9-74
 Results display examples, 1-10
 Results storage set-up, 2-5
 Revision Date Query,REV?, 9-26
 REV?,Revision Date Query, 9-26
 RFA?,Frame Analysis Result Query, 9-85
 RFE?,Frame Error Result Query, 9-82
 RMT,Remote, 9-22
 Round Trip Delay measurement, 3-36
 Round Trip Delay Query,RRT?, 9-88
 Round trip delay test example, 3-35
 RPS?,Pattern Slips Result Query, 9-89
 RQS,Request Service Mask, 9-24
 RRA?,REBE Analysis Result Query, 9-86
 RRE?,REBE Error Result Query, 9-83
 RRT?,Round Trip Delay Query, 9-88
 RS-232 Port (on side panel), 7-7

RSB?,Bit Error Result Query, 9-81
 RSC?,Code Error Result Query, 9-82
 RSF?,Frequency Result Query, 9-87
 RSP?,Slip result query, 9-94
 RST,Reset, 9-21
 RTM,Receiver Multiple Timeslot Selection, 9-37
 RTS,Receiver Single Timeslot, 9-36
 RWD?,Wander result query, 9-95
 RXT,Receive Timeslot, 9-36

S

SAB,Spare National Bits Set-Up, 9-58
 SAC,Spare CRC4 NFAS Frame A-bits Codeword, 9-59
 SAD,CAS Multiframe ABCD Bits Set-Up, 9-60
 Safety Considerations, 6-2
 SAH,Codeword Into NFAS Frame Bit Enable, 9-60
 SALR?,Stored Alarm Seconds Result Query, 9-112
 SAN,Codeword Into NFAS Frame Bit Number, 9-59
 SAPP?,Stored Application Mode Query, 9-103
 Save Settings,SAV, 9-44
 SAV,Save Settings, 9-44
 SBRR?,Stored Bearer Rate Query, 9-103
 SCCN?, Stored sub rate channel number query, 9-106
 SCCN?,Stored Sub Rate Circuit Number Query, 9-105
 SCOD?,Stored Ternary Linecode Query, 9-103
 SDO,Sub Rate Deselected Octets Pattern, 9-40
 SEA,Single Error Add, 9-54
 SEB,E-Bits Set-Up, 9-58

Selecting Standard Annex D Thresholds, 2-10

Self tests
 for calibration, telecom, 8-7
 Telecom (host instrument), 8-7

Self-test, TST, 9-21

SELP?, Stored Elapsed Time Result Query, 9-113

Serial Number Query, SER, 9-26

SER, Serial Number Query, 9-26

Service octet selection, X.58, 2-14

SES Analysis Threshold, THS, 9-79

Set pattern loss threshold, PLS, 9-42

Settings Lock, SLK, 9-44

SFRM?, Stored Framing Type Query, 9-103

Show History Status Query, HIS?, 9-54

SIB, Spare International Bits Set-Up, 9-58

SIFC?, Stored Interface Type Query, 9-103

Signaling bit display selection, 3-47

Signaling bits selection, 2-8

Signaling protocol test example, 3-51

Signal measurement selection, 3-36

Signal result display, 4-11

SIG?, Timeslot Monitor All Signaling Bits Query, 9-90

Single channel loopback test example, 3-11

Single error add example, 1-7

Single Error Add, SEA, 9-54

SL2100? stored M.2100 limits, 9-43

Slip result query, RSF?, 9-94

Slip result query, SRWD?, 9-115

Slips, investigating the source of, 3-71

SLK, Settings Lock, 9-44

SLUS?, Stored Long User Word Number Query, 9-104

SM2100? stored M.2100 result query, 9-113

SM2100? stored M>2120 report count query, 9-114

SM2110? stored M.2110 pass fail query, 9-114

SMC?, Detailed Store Use Query, 9-97

SMDA, Delete all SMG stores, 9-98

SMDS, Delete one SMG store, 9-98

SMD?, Stored Graphical data Query, 9-99

SMF, CAS Multiframe Bits Set-Up, 9-60

SMPA? stored path allocation, 9-43

SMS?, Store Size and Usage, 9-96

SMZ?, Stored Graphical Data in Compressed Form Query, 9-101

Spare CRC4 NFAS Frame A-bits Codeword, SAC, 9-59

Spare International Bits Set-Up, SIB, 9-58

Spare National Bits Set-Up, SAB, 9-58

SPAT?, Stored Pattern Type Query, 9-104

SPAU?, Stored User Defined Word Pattern Query, 9-104

Speaker Enable, SPK, 9-41

SPECIAL?, Instrument Special Option Query, 9-57

Specification, 6-1, 6-4

Speech quality test example, 3-30

SPK, Speaker Enable, 9-41

SPPO?, Stored PRBS Polarity Query, 9-104

SRAT?, Stored Analysis Measurement Parameters Query, 9-109

SRBA?, Stored Bit Analysis Result Query, 9-109

SRCA?, Stored CRC Analysis Result Query, 9-111

SRD, Sub Rate Monitor Result Display, 9-75

SRFA?, Stored Frame Analysis Result Query, 9-110

SRFE?, Stored Frame Error Result Query, 9-107, 9-108
 SRF, Sub Rate FAS Word Monitor For X.58, 9-77
 SRG, Store Measurement Results Enable, 9-96
 SRO, Sub rate monitor octet number, 9-77
 SRRA?, Stored REBE Analysis Result Query, 9-111
 SRRE?, Stored REBE Error Result Query, 9-108
 SRSB?, Stored Bit Error Result Query, 9-106
 SRSC?, Stored Code Error Result Query, 9-107
 SRSP?, Stored slip result query, 9-114
 SRS, Sub Rate Structure, 9-30
 SRTM?, Stored Receiver Multiple Timeslot Selection Query, 9-105
 SRTS?, Stored Receiver Single Timeslot Query, 9-106
 SRT, Sub Rate Bearer Timeslot, 9-37
 SRV, Sub Rate Service Bits Monitor For X.58, 9-78
 SRWD?, Slip result query, 9-115
 SSRT?, Stored sub rate bearer timeslot query, 9-106
 SSV, CAS Multiframe Service Bits (704 kb/s) Set-Up, 9-61
 Start Testing, STR, 9-52
 STA?, Status/Events Query, 9-27
 Status, alarm indication example, 1-9
 Status/Events Query, STA?, 9-27
 Status Query, STB?, 9-27
 Status register A, 9-120
 Status register B, 9-123
 Status registers, 9-120
 STB?, Status Query, 9-27
 STFF?, Stored Tone Frequency Query, 9-105
 STFL?, Stored Tone Level Query, 9-105
 STFU?, Stored User Defined Tone Frequency Query, 9-105
 Stop Testing, STP, 9-52
 Storage and Shipment, 7-13
 Stored Alarm Seconds Result Query, SALR?, 9-112
 Stored Analysis Measurement Parameters Query, SRAT?, 9-109
 Stored Application Mode Query, SAPP?, 9-103
 Stored Bearer Rate Query, SBRR?, 9-103
 Stored Bit Analysis Result Query, SRBA?, 9-109
 Stored Bit Error Result Query, SRSB?, 9-106
 Stored Code Error Result Query, SRSC?, 9-107
 Stored CRC Analysis Result Query, SRCA?, 9-111
 Stored Elapsed Time Result Query, SELP?, 9-113
 Stored Frame Analysis Result Query, SRFA?, 9-110
 Stored Frame Error Result Query, SRFE?, 9-107, 9-108
 Stored Framing Type Query, SFRM?, 9-103
 Stored Graphical Data in Compressed Form Query, SMZ?, 9-101
 Stored Graphical data Query, SMD?, 9-99
 Stored Interface Type Query, SIFC?, 9-103
 Stored Long User Word Number Query, SLUS?, 9-104
 Stored M.2100 limits SL2100?, 9-43
 stored M.2100 result query, SM2100?, 9-113
 stored M.2110 pass fail query, SM2110?, 9-114

Stored M>2120 report count query,
 SM2100?, 9-114
 Stored Measurement and Graphic
 Commands, 9-96
 Stored path allocation, SMPA?, 9-43
 Stored Pattern Type Query, SPAT?,
 9-104
 Stored PRBS Polarity Query, SPPO?,
 9-104
 Stored REBE Analysis Result
 Query, SRRA?, 9-111
 Stored REBE Error Result
 Query, SRRE?, 9-108
 Stored Receiver Multiple Timeslot
 Selection Query, SRTM?, 9-105
 Stored Receiver Single Timeslot
 Query, SRTS?, 9-106
 Stored results display choices, 4-15
 Stored results display, leaving, 4-17
 Stored results display selection, 4-15
 Stored set-up naming, 2-19
 Stored set-up recall, 2-4
 Stored slip result query, SRWD?, 9-114
 Stored sub rate bearer timeslot query,
 SSRT?, 9-106
 Stored sub rate channel number query,
 SCCN?, 9-106
 Stored Sub Rate Circuit Number
 Query, SCCN?, 9-105
 Stored Ternary Linecode Query, SCOD?,
 9-103
 Stored Tone Frequency Query, STFF?,
 9-105
 Stored Tone Level Query, STFL?, 9-105
 Stored User Defined Tone Frequency
 Query, STFU?, 9-105
 Stored User Defined Word Pattern
 Query, SPAU?, 9-104
 Store Measurement Results Enable, SRG,
 9-96
 Store results set-up, 2-5

Store Size and Usage, SMS?, 9-96
 Stores SMG Delete all, SMDA, 9-98
 Stores SMG Delete one, SMDS, 9-98
 Storing test set-ups, 2-17
 STP, Stop Testing, 9-52
 STR, Start Testing, 9-52
 Stuck bits monitor example, 3-46
 Sub Rate Bearer Rate, BRR, 9-31
 Sub Rate Bearer Timeslot, SRT, 9-37
 Sub rate burst error length, BEA, 9-67
 Sub Rate Channel Number, CCN, 9-37
 Sub-rate data bit monitor, 3-61
 Sub Rate Deselected Octets
 Pattern, SDO, 9-40
 Sub rate error testing example, 3-25
 Sub Rate FAS Word Monitor For
 X.58, SRF, 9-77
 Sub-rate frame bit monitor, 3-61
 Sub rate monitor octet number, SRO,
 9-77
 Sub Rate Monitor Result Display, SRD,
 9-75
 Sub Rate Service Bits Monitor For
 X.58, SRV, 9-78
 Sub Rate Structure, SRS, 9-30
 Sub Rate X.50 DIV 2 FAS Bits Set-
 Up, XFA, 9-61
 Sub Rate X.50 DIV 3 FAS Bits Set-
 Up, XFB, 9-62
 Sub Rate X.50 Status Bit, XSB, 9-34
 Sub Rate X.58 Service Octets Set-
 Up, XFS, 9-62
 Switch On, 1-2
 Sync loss threshold tests, 3-15

T

T1 / Datacom selection, 7-6
 Talk / listen selection, 2-23
 TCL, Transmitter Clock Source, 9-32
 TCP, Binary Interface Transmit Clock
 Phase, 9-30

TDU, User Defined Test Period, 9-74
 Telecom / Datacom selection, 1-2, 2-2
 Telecom functions self tests, 8-7
 Telecom testing, list of examples, 3-2
 Telephone lines, connecting to via
 modems, 9-2
 Terminal, control from, 9-7
 Terminal, setting up for operation from,
 9-4
 Ternary Linecode, COD, 9-30
 Test equipment
 Performance tests, 8-2
 Test Period and Results Configuration
 Commands, 9-72
 Test Period Duration, TPR, 9-73
 Test period setting, 2-7
 Test Period Type, TTY, 9-72
 Test record
 Operational verification, telecom,
 8-28
 Test record, performance tests, 8-84
 Test setup storing, 2-17
 TFF, Tone Frequency, 9-34
 TFL, Tone Level, 9-35
 TFU, User Defined Tone Frequency,
 9-35
 THD, Degraded Minutes Analysis
 Threshold, 9-79
 Thinkjet printer setup example, 5-3
 Threshold selection, analysis, 2-10, 2-11
 Threshold testing of Mux, test example,
 3-15
 Through mode selection, 3-49
 Through Mode, THU, 9-32
 THS, SES Analysis Threshold, 9-79
 THT, Analysis Threshold Type, 9-78
 THU, Through Mode, 9-32
 Timed measurement start selection,
 2-25
 Timed start of measurement, 6-45
 Timed start, TMST, 9-53, 9-72
 Time setting, 2-20
 Time Set-Up, TIM, 9-46
 Timeslot 16 signalling, monitor example,
 3-46
 Timeslot Integrity test example, 3-7
 Timeslot Monitor All NFAS Bits
 Query, NFS?, 9-91
 Timeslot Monitor All Signaling Bits
 Query, SIG?, 9-90
 Timeslot monitor, data bits, example,
 3-9
 Timeslot Monitor NFAS Latch
 Query, NFL?, 9-91
 Timeslot Monitor NFAS Latch
 Timestamp Query, NFT?, 9-91
 Timeslot Monitor Query, BIT?, 9-90
 Timeslot monitor selection, 3-47
 Timeslot NFAS Display event Capture
 Mode, TNF, 9-76
 Timeslot NFAS Display Latch
 Mask, TNL, 9-77
 Timeslot Result Display, TRD, 9-74
 Timeslot selection, 3-7
 Timeslot Selection For Data and
 Signaling, TSD, 9-76
 Timeslot Signaling Selection - All or
 Single, TSS, 9-76
 Timeslot tracing, 3-9
 TIMS at digital interfaces, 3-34
 TIMS interface, example, 3-30
 TIMS testing, 3-32
 TIM, Time Set-Up, 9-46
 TMST, Timed start, 9-53, 9-72
 TNF, Timeslot NFAS Display event
 Capture Mode, 9-76
 TNL, Timeslot NFAS Display Latch
 Mask, 9-77
 TOC, Transmitter Octet Timing, 9-32
 Tone frequency measurement, 3-34
 Tone Frequency Result Query, TSF?,
 9-89

Tone Frequency, TFF, 9-34
 Tone generation, 3-32
 Tone level measurement, 3-34
 Tone Level Result Query, TSL?, 9-89
 Tone Level, TFL, 9-35
 TPR, Test Period Duration, 9-73
 TR2 limits for M.2120 tests, selection, 2-26
 Tracing an individual timeslot, 3-9
 Transmit Single Timeslot, TTS, 9-36
 Transmitter Clock Source, TCL, 9-32
 Transmitter Multiple Timeslot Selection, TTM, 9-35
 Transmitter Octet Timing, TOC, 9-32
 Transmit timeslot selection, 3-7
 TRD, Timeslot Result Display, 9-74
 Trouble scan display selection, 4-6
 Troubleshooting Telecom networks, list of examples, 3-3
 TSD, Timeslot Selection For Data and Signaling, 9-76
 TSF?, Tone Frequency Result Query, 9-89
 TSL?, Tone Level Result Query, 9-89
 TSS, Timeslot Signaling Selection - All or Single, 9-76
 TST, Self-test, 9-21
 TTM, Transmitter Multiple Timeslot Selection, 9-35
 TTS, Transmit Single Timeslot, 9-36
 TTY, Test Period Type, 9-72
 Tx/Rx rates, full list, 3-70

U

Unframed, far end loopback, test example, 3-4
 Unframed, local loop, test example, 3-5
 Unselected timeslot content, 2-12
 User Defined Continuous Frame Error Add, FEU, 9-70

User Defined Test Period, TDU, 9-74
 User Defined Tone Frequency, TFU, 9-35
 User Defined Word Pattern, PAU, 9-34
 User protocol insertion, 3-66

V

Voice actuated switch test example, 3-32
 Volume Control, VOL, 9-54
 VOL, Volume Control, 9-54

W

Wander (peak) measurement, 3-71
 Wander result query, RWD?, 9-95
 Wideband error isolation in service test example, 3-48
 Wideband signal tracing example, 3-7
 Wideband test pattern insertion example, 3-48

X

X.50 div 2, FAS bits selection, 2-14
 X.50 div 3, FAS bits selection, 2-14
 X.50/X.58 Sub rate error testing example, 3-25
 X.53 mapping selection, 2-14
 X.53 mapping standard, XMAP, 9-64
 X.53 mapping, user defined, X53, 9-62
 X.58 service octet selection, 2-14
 XFA, Sub Rate X.50 DIV 2 FAS Bits Set-Up, 9-61
 XFB, Sub Rate X.50 DIV 3 FAS Bits Set-Up, 9-62
 XFS, Sub Rate X.58 Service Octets Set-Up, 9-62
 XMAP, X.53 mapping standard, 9-64
 XSB, Sub Rate X.50 Status Bit, 9-34

Z

Zoom in / zoom out, 4-14

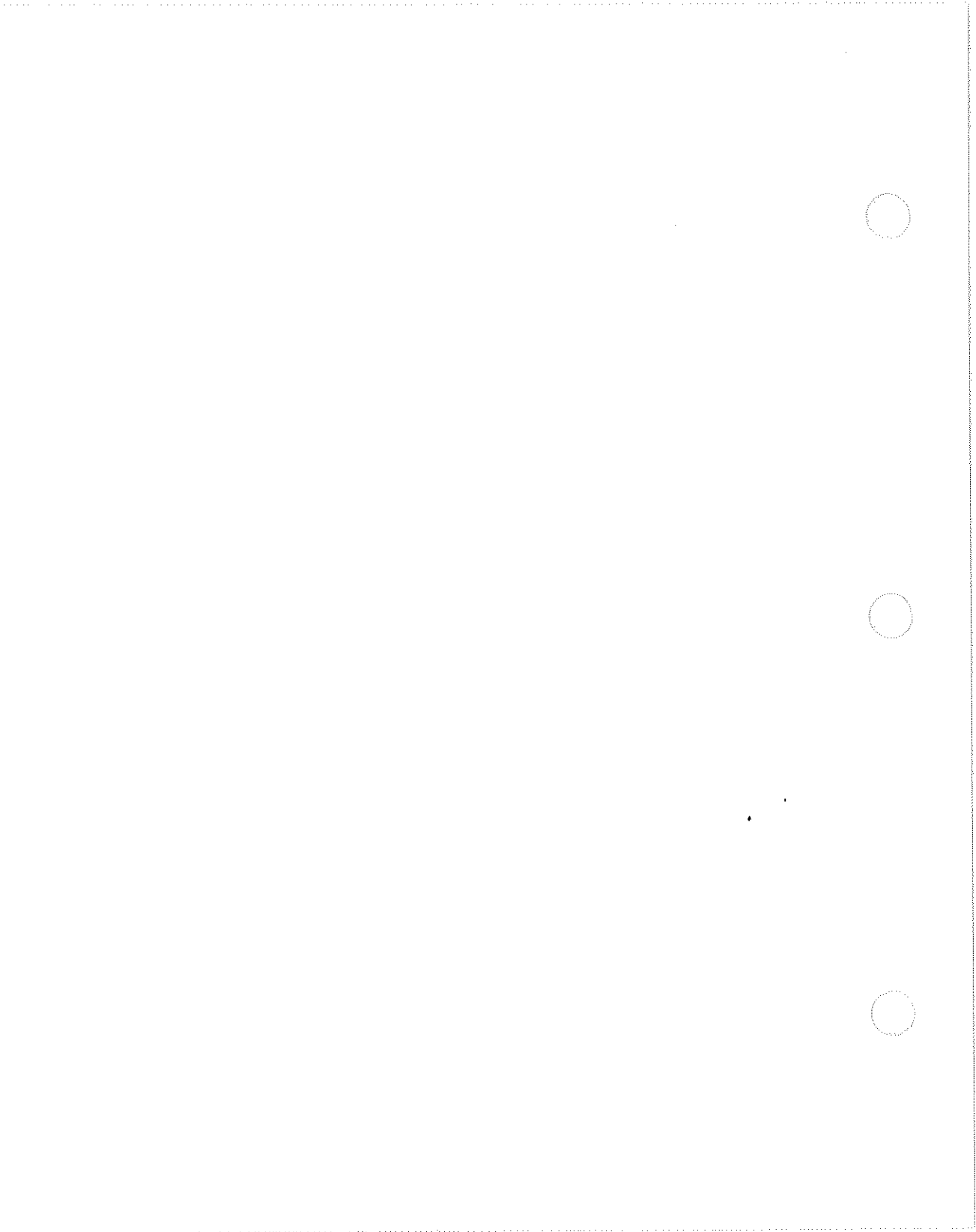

Hewlett-Packard Sales and Service Offices

United States:

Hewlett-Packard Company
2101 Gaither Road
Rockville
MD 20850
(301) 258-2000

Hewlett-Packard Company
5201 Tollview Drive
Rolling Meadows
IL 60008
(708) 255-9800

Hewlett-Packard Company
1421 S. Manhattan Avenue
Fullerton
CA 92631
(714) 999-6700

Hewlett-Packard Company
2000 South Park Place
Atlanta
GA 30339
(404) 955-1500

Canada:

Hewlett-Packard Canada Ltd.
5150 Spectrum Way
Mississauga
Ontario
L4W 5G1
(416) 206-4725

Europe:

Hewlett-Packard
European Marketing Centre
PO Box 999
1180 AZ Amstelveen
The Netherlands

Japan:

Yokogawa-Hewlett-Packard Ltd.
Measurement Assistance Center
9-1, Takakura-Cho
Hachioji-Shi
Tokyo 192
Japan
(81) 426 48 0722

Latin America:

Hewlett-Packard
Latin America Region Headquarters
5200 Blue Lagoon Drive
9th Floor
Miami
Florida 33126
USA
(305) 267 4245/4220

Australia/New Zealand:

Hewlett-Packard Australia Ltd.
31-41 Joseph Street
Blackburn
Victoria 3130
Australia
Melbourne Caller 272 2555
(008) 13 1347

Far East:

Hewlett Packard Pacific Ltd.
22-30/F Peregrine Tower
Lippo Centre
89 Queensway
Central
Hong Kong
(852) 848 7070

